

TRANSLATION OF THE ORIGINAL VERSION



# Operating Manual

Lightweight Aluminium Scissor Lift Table with Foot-Hydraulics

Type HS 200 | FH



*Valid for type:* **HS 200 | FH**

**Reinhold Beck Maschinenbau GmbH**

Im Grund 23 | DE -72505 Krauchenwies

Tel.: +49 (0) 7576 / 962 978 - 0 | Fax: +49 (0) 7576 / 962 978 - 90

E-Mail: [info@beck-maschinenbau.de](mailto:info@beck-maschinenbau.de) | Web: <https://www.beck-maschinenbau.de>

# Table of Contents

1	Introduction.....	4
1.1	Legal Notice .....	4
1.2	Illustrations.....	4
2	Symbols .....	4
2.1	General Symbols.....	4
2.2	Symbols in Safety Instructions .....	5
3	General.....	6
3.1	Advantages.....	6
3.2	Applications.....	6
3.3	Target Group and Previous Experience.....	6
3.4	Requirements for the Operators .....	6
3.5	Accident Prevention .....	7
3.6	General Safety Regulations.....	7
3.7	Standard Equipment .....	7
3.8	Options and Accessories.....	7
4	Safety .....	8
4.1	Basic Safety Instructions.....	8
4.2	Application Area and Intended Use.....	8
4.3	Improper Use.....	8
4.4	Consequences in Case of Disregard .....	9
4.5	Conversions and Modifications of the Lift Tables .....	9
4.6	Load Distribution and Influence on the Nominal Load.....	9
4.7	Hazardous Areas .....	10
4.8	Residual Risks .....	11
4.9	Observe the Environmental Protection Regulations .....	11
4.10	Organisational Measures.....	12
4.11	Personnel Selection and Qualification - Basic Duties .....	12
5	Technical Specifications .....	13
5.1	Manufacturer and Nameplate.....	13
6	Transport to the Installation Site .....	14
6.1	Unloading the Lift Table.....	14
6.2	Requirements for the Installation Site .....	15
6.3	Temporary Storage .....	15
6.3.1	Short Term Storage.....	15
6.3.2	Long Term Storage.....	15
6.4	Lashing on a Transport Vehicle .....	15
7	Components and Controls.....	16
8	Installation and Commissioning .....	17
9	Operation .....	17
9.1	Load and Unload the Lift Table .....	17
9.2	Moving the Lift Table via Swivel Castors .....	17
9.3	Lifting and Lowering the Platform .....	17
9.3.1	Height Adjustment .....	18
		2

10	Troubleshooting.....	18
11	Maintenance and Repair .....	19
11.1	Safety Catch for Securing.....	19
11.1.1	Replacing the Hydraulic Cylinder.....	19
11.2	Maintenance Intervals.....	19
12	Optional Table Tops .....	20
12.1	Table Top AW 100 Smooth .....	20
12.2	Table Top Beech Multiplex .....	20
12.3	Table Top Hole Grid Multiplex .....	20
13	Decommissioning.....	21
14	Disassembly and Scrapping .....	21
15	Options and Accessories .....	22
15.1	Table Tops .....	22
15.1.1	Accessories for Table Top Hole Grid Beech-Multiplex.....	22
	EU - Declaration of Conformity.....	24

## List of Figures

Figure 1: Permissible load with load distribution .....	9
Figure 2: Nameplate .....	13
Figure 3: Components and controls .....	16
Figure 4: Foot bar and brakes .....	18
Figure 5: Safety catch for securing .....	19
Figure 6: Table Top AW 100 Smooth.....	20
Figure 7: Table Top Beech-Multiplex.....	20
Figure 8: Table Top Multiplex Hole Grid.....	20

### Revisions:

Revision	Autor	Modification	Date
001	AG	Original manual translated	25.10.2021

# 1 Introduction

The information in this operating manual enables safe, proper and economical operation of your lift table. Please observe all the explanations, notes and regulations

- to avoid dangers and malfunctions,
- to reduce repair costs and downtimes
- and to increase reliability and service life

of your lift table.

The operating manual must be read and used by each person entrusted with carrying out work with the lift table. This must be ensured by the operator. Further this manual as well as any appendices and additional documents must be kept easily accessible at the place of use of the lift table.

	<p><b><i>Ignorance or non-observance of these operating instructions may result in certain accident hazards during <u>handling</u> with the lift table. Before commissioning, this operating manual and any appendices and additional documents must be read thoroughly. All instructions, in particular the safety regulations, must be observed!</i></b></p> <p><b><i>Handling</i></b> the lift table in the sense of these instructions means</p> <ul style="list-style-type: none"> <li>• the installation and commissioning,</li> <li>• the operation and proper usage,</li> <li>• the influence on operating conditions, as well as</li> <li>• the maintenance, troubleshooting and repair.</li> </ul>
---	--

Apart from the operating manual and the legally binding accident prevention provisions applicable in the country and place of use, the recognized technical regulations for safe and proper work must also be observed.

## 1.1 Legal Notice



All contents of these operating instructions are subject to the rights of use and copyright of Reinhold Beck Maschinenbau GmbH. Any reproduction, modification, further use and publication in other electronic or printed media, as well as their online publication, requires the prior written consent of Reinhold Beck Maschinenbau GmbH.

## 1.2 Illustrations

All photos, figures and graphics contained in this document are for illustration and better understanding only and may differ from the current state of the product.

# 2 Symbols

## 2.1 General Symbols

<b>Symbol</b>	<b>Meaning</b>
	Indicates passages within this operating manual that must be particularly observed in order to prevent malfunctions or damage to the lift table.
	Refers to chapters, sections, or figures within this document.
	Refers to an external document or a third-party source.

## 2.2 Symbols in Safety Instructions

The lift table is designed and manufactured according to the current state of the art. Nevertheless, residual hazards may occur during handling. In this operating manual, possible dangers and residual risks are pointed out at appropriate places.

Safety instructions are provided with corresponding danger symbols which have the following meanings:

Symbol	Safety Instruction
	Reading and applying the operating manual is mandatory for the operating personnel. <i>Failure to abide by the following precautions could lead to serious or possibly fatal injury.</i>
	General danger symbol, which requires the highest attention! <i>Failure to observe may result in damage to the equipment, serious injury or even death.</i>
	Reference to a prohibited zone under a lifted load! <i>Do not enter! There is an increased risk of injury or even death.</i>
	Reference to a prohibited zone on a platform! <i>Do not enter! There is an increased risk of injury or even death.</i>
	Reference to a possible crushing hazard! <i>Non-observance increases the risk of injury to hands and fingers!</i>
	Reference to a possible crushing hazard! <i>Non-observance increases the risk of injury to feet and toes!</i>
	Possible dangerous crushing hazard in the area of stationary objects! <i>Risk of personal injury and possibly additional equipment damage.</i>
	Reference to a possible hazard due to forklift traffic! <i>Non-observance can result in life-threatening injuries.</i>
	Reference to a possible danger under suspended loads! <i>Non-observance can result in life-threatening injuries.</i>
	Reference to possible tripping and slipping hazards on the floor! <i>Non-observance may result in minor or severe injuries.</i>
	Reference to possible environmental pollution! <i>Non-observance poses a risk of pollution of the environment and groundwater!</i>
	Reference to the obligation to wear safety shoes resp. protective gloves! <i>Non-observance may result in increased risk of injury to feet &amp; toes or hands &amp; fingers!</i>
	Fire hazard! Do not smoke and do not ignite open fire.
	Access for unauthorized persons prohibited! <i>Risk of personal injury and possibly additional equipment damage.</i>

## 3 General



***The operating manual must be read carefully and understood before handling the lift table! If anything is unclear, please contact the manufacturer.***

The HS 200 lightweight scissor lift table has been specially designed for use outside the company, for example by service technicians, fitters or craftsmen. Due to its low weight and compact design, it can be quickly and easily stowed in the service vehicle.

It is therefore suitable for countless applications in industry and trade, e.g. for maintenance, assembly and repair work in refrigeration industry. The basic model is already equipped with an aluminium table top. Further table tops are optionally available. These can be plugged onto the substructure and allow individual adaptation to different applications.

### 3.1 Advantages

- Mobile lightweight aluminium construction with high load-bearing capacity
- Ideal for service applications thanks to light weight and compact design
- Uniform adjustment to height, even under uneven load distribution
- Back-friendly, foot-operated hydraulic height adjustment
- High-quality, side-mounted hydraulic unit
- Flexible and versatile applications

### 3.2 Applications

HS 200 can be used for all work corresponding to its intended use in section ⇒ 4.2. The lift table is suitable for use as work equipment for transporting, lifting and lowering loads and also as a height-adjustable assembly table. Typical areas of application are workplaces in manufacturing, assembly and maintenance, where precise height adjustment for ergonomic working as well as high flexibility and mobility are of particular importance.

The lift table must not be used for work that does not correspond to its intended use (see section ⇒ 4.2).

### 3.3 Target Group and Previous Experience

This operating manual is intended for the operating and maintenance personnel of the lift table. The operating personnel is to be determined by the operator and must further meet the following requirements:

- Basic technical and mechanical knowledge as well as knowledge of the associated technical terms
- Reading and understanding these operating and maintenance instructions

In order to acquire the knowledge required to operate this lift table, the operator must ensure the following measures:

- Product training for every operator (also possible external personnel)
- Regular safety instruction

### 3.4 Requirements for the Operators

- ⚠ The operator is responsible for the safe use of the lift table!
- ⚠ The lift table may only be operated by trained personnel who have also read this manual.
- ⚠ Inspection, maintenance, cleaning and repair may only be performed by technical specialists with product-specific training and mechanical and/or electrical training.
- ⚠ Specialists with product-specific training are to be commissioned and held responsible for planning and checking the work.
- ⚠ The national protective regulations for employees must be observed
- ⚠ The legal minimum age must be observed.

### 3.5 Accident Prevention

To avoid accidents, the following rules must be observed for operation:

- ⚠ Prevent unauthorized persons from gaining access to the lift table.
- ⚠ Keep unauthorized persons away from the danger areas.
- ⚠ Repeatedly inform present other persons about existing residual risks (see section ⇒ 4.8 "Residual Risks").
- ⚠ Conduct and record regular training & instruction for persons who must be in the area of the lift table.
- ⚠ New employees must be trained internally to work on a lift table and this training must be documented.
- ⚠ It is not permitted to enter the lift table platform or to transport resp. lift persons.

### 3.6 General Safety Regulations

In general, the following safety regulations and obligations apply when handling the lift table:

- ⚠ The lift table may only be operated when it is in perfect working order.
- ⚠ It is prohibited to remove, modify or bypass any protective, safety or monitoring equipment.
- ⚠ It is forbidden to modify or alter the lift table without the written approval of the manufacturer / supplier.
- ⚠ Faults or damage must be reported to the operator immediately, eliminated without delay and repaired if necessary.
- ⚠ Repair and maintenance work on hydraulic components (e.g. hydraulic cylinders) may only be performed by authorized and trained personnel.
- ⚠ Repair and maintenance work may only be carried out if the lift table has been secured with the safety catch beforehand (see section ⇒ 11.1).
- ⚠ Maintenance must be carried out and documented in accordance with the maintenance instructions.
- ⚠ For repairs, only original spare parts from the manufacturer may be used.
- ⚠ Only instructed, trained or qualified persons may work on the lift table.
- ⚠ For the operation of the lift table, the respective national safety regulations for employees as well as the national safety and accident prevention regulations apply.

### 3.7 Standard Equipment

- Uniform height adjustment even with uneven load distribution or eccentric loading.
- Stowable in the service vehicle thanks to lightweight aluminium construction and compact design.
- Four swivel castors for mobile use and two parking brakes on the left longitudinal side.
- Stepless foot-operated hydraulic height adjustment up/down via foot bar.
- High load capacity of 200 kg with a tare weight of only 30 kg.
- Safety catch for securing during maintenance work.
- Stable and additionally reinforced scissors.
- Versatile and flexible use.
- CE-compliant design.

### 3.8 Options and Accessories

Optionally selectable table tops can be found in chapter ⇒ 12 and further accessories in chapter ⇒ 15.

## 4 Safety

### 4.1 Basic Safety Instructions

Lift tables can be dangerous if used improperly. Therefore, observe the safety instructions listed in this chapter and the accident prevention regulations of your employer's liability insurance association!



***The manufacturer accepts no liability for damage and malfunctions resulting from failure to observe these operating instructions.***

### 4.2 Application Area and Intended Use

The foot pedal operated, hydraulically adjustable lift tables of the HS series conform to the Machinery Directive 2006/42/EC and are therefore suitable as technical equipment for both industrial and commercial applications as well as for training purposes in educational institutions.



***Improper use can lead to danger to persons and to a defect or damage to the lift table.***

- ⚠ The lift table is primarily intended for operation in covered indoor areas, but it can also be used outdoors for loading and unloading purposes (e.g. from the service vehicle to the place of use).
- ⚠ Work on the lift table may only be performed at sufficiently illuminated workplaces.
- ⚠ The lift table is intended for processing, equipping, assembling and transporting assemblies, workpieces and similar components as well as for lifting, lowering and moving loads.
- ⚠ The lift table may only be used on horizontal floors for lifting loads.
- ⚠ The lift table may only be moved when the load is lowered.
- ⚠ The lift table must be positioned freely in the room when lifting and lowering. This means that no shearing or crushing edges may be caused by the movement of the lift table.
- ⚠ The maximum load (see ⇒ 5 “Technical Specifications”) with load center in the middle of the lift table must not be exceeded. If the lift table is loaded unevenly, outside the load center of gravity, the load capacity is reduced to up to 33 % of the maximum permitted load capacity (see ⇒ Figure 1).
- ⚠ The lift table is not intended for moving and transporting persons.
- ⚠ The lift table must not be operated in potentially explosive working areas.
- ⚠ Any other use is considered improper and prohibited.

### 4.3 Improper Use

Improper use is when the lift table is used for purposes other than those prescribed in this operating manual and in section ⇒ 4.2, for example

- ⚠ Use and application for private or non-commercial purposes,
- ⚠ Use in disregard of the regulations in the operating manual,
- ⚠ Use after unauthorized conversions or modifications,
- ⚠ Exceeding the maximum permissible load (see ⇒ 5 “Technical Specifications”)
- ⚠ Transporting or conveying persons with the lift table
- ⚠ Entering the lift table

In case of improper use of the lift table, any warranty, liability and other claims for damages of the operator against the manufacturer are excluded!



## 4.4 Consequences in Case of Disregard

If the lift table is not operated, maintained or repaired in accordance with the safety regulations, not as intended, improperly or in an abusive manner, the following will result:

- ⚠ Dangers to the health of the operating personnel
- ⚠ Dangers to the lift table and objects in its vicinity
- ⚠ Impairment of the lift table function

In case of improper use of the lift table, any warranty, liability and other claims for damages of the operator against the manufacturer are excluded!

## 4.5 Conversions and Modifications of the Lift Table

- ⚠ Only use the lift table in its original condition, i.e. as delivered!
- ⚠ The components of the lift table must not be changed in their type and condition.
- ⚠ Only original spare parts and accessories from the manufacturer (see ⇨ 15) may be used.
- ⚠ Deviations are not permitted.

	<p><b><i>Unauthorized modifications or conversions by the operator, without the written consent of the manufacturer, are prohibited. This excludes any warranty, liability and other claims for damages by the operator against the manufacturer!</i></b></p>
---	---

## 4.6 Load Distribution and Influence on the Nominal Load

The nominal, maximum permissible load of 200 kg is based on a load evenly distributed on the lift table platform. If the load cannot be distributed evenly on the platform, the maximum permissible load must be reduced according to the figures below.

Figure 1: Permissible load with load distribution

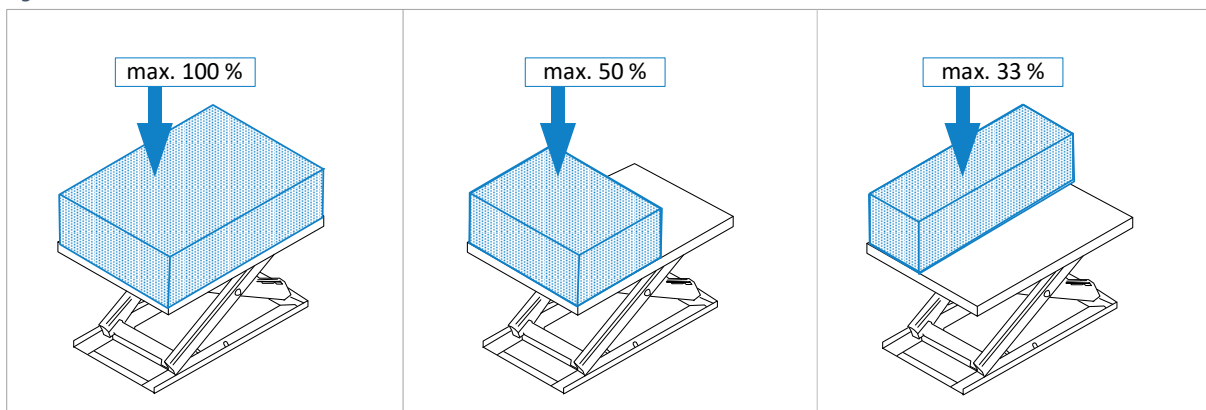

### Even distribution

Load is evenly distributed over the entire platform area  
 → 100 % of the nominal load is permissible.



### Uneven distribution

Load is distributed over half of the platform in transverse direction  
 → 50 % of the nominal load is permissible.

### Uneven distribution















Load is distributed over half of the platform in longitudinal direction  
 → 33 % of the nominal load is permissible.

## 4.7 Hazardous Areas

Source	Area	Cause	Risk	Prevention
<b>Foot pump</b> 	On the foot bar for height adjustment	Slipping off the foot bar	Injuries to feet and legs	Keep foot bar and shoes dry Wear work shoes with non-slip soles
<b>Mechanics</b> 	Lifting scissor / Subframe	Crushing and shearing points	Loss of limbs, crushing of hands, increased risk of injury and even death	Do not reach under the tabletop or into the scissors during operation and do not move your body into this area  Before maintenance work, always lock the safety catch to secure the platform first (see section ⇒ 11.1)
<b>Hydraulic system</b> 	On hydraulic cylinders and all oil-bearing parts, seals and lines	Oil spraying out with high pressure in case of damaged cylinder or seals	Injuries and poisoning of the eyes	Wear safety goggles or face shield Repair damaged parts and/or seals immediately (only qualified personnel!)

## 4.8 Residual Risks

The lift table is built according to the latest state of the art and the recognised safety rules. Nevertheless, the use of the lift table may cause danger to life and limb of the user or third parties or damage to the lift table and other equipment. Due to the construction of the lift table, the following residual risks can occur even when used as intended and despite compliance with all relevant safety regulations:

	Reading and applying the operating manual is mandatory for the operating personnel.
	Be alert to possible crushing hazards: a) when transporting the lift table by forklift truck: between forks & pallet / lift table b) when picking up the lift table: between lift table / pallet and floor c) when lowering the lift table: between lift table and fixed equipment
	Be alert to possible crushing hazards when lowering the lift table (from the cargo pallet to the floor) with a forklift truck or overhead crane.
	Be aware of the danger from falling objects such as workpieces, tools or similar. Therefore, wear safety shoes, especially when transporting and setting down the lift table.
	It is strictly forbidden to "ride along" with the lift table during a lifting operation (by means of a forklift truck or overhead crane). There is a high risk of falling!
	It is strictly forbidden to enter or climb onto the lift table during a lifting operation (by means of a forklift truck or overhead crane). There is a high risk of falling!
	Increased risk of injury or even death. Entering the danger zone under a lifted load during transport or installation by means of a forklift truck is prohibited!
	Increased risk of injury or even death. It is forbidden to enter the forklift platform during transport or installation!
	Unauthorised persons are not allowed to enter the lift table installation area (responsibility of the operator).
	Stop! Do not work under the lift table platform until it is mechanically locked via the safety catch. Non-compliance can result in life-threatening injuries.
	Be aware of possible tripping and slipping hazards on the floor. Prevent possible hazards by keeping the floor dry and clean and by using anti-slip floor coverings around the lift table.
	Acute danger of crushing underneath the table top! Never reach into the shears and never move your body into this area! There is an increased risk of accidents with loss of limbs or even death.
	When using additional machines on the lift table, first read the respective operating instructions and comply with the specified safety regulations.
	Be aware of the fire hazard during the processing of wood due to wood dust, in connection with flying sparks and/or open fire!

## 4.9 Observe the Environmental Protection Regulations

During all work with the lift table, the environmental protection regulations, obligations and laws for waste avoidance and proper recycling and/or disposal applicable at the place of use must be observed. This applies in particular to installation, repair and maintenance work involving substances that could pollute the groundwater (e.g. hydraulic oils and cleaning agents and liquids containing solvents). In any case, prevent them from seeping into the ground or entering the sewage system.

	<b>Store and transport the above-mentioned hazardous substances only in suitable containers. Avoid leakage of hazardous substances by using suitable collection containers. Ensure that the above-mentioned substances are disposed of by a qualified disposal company.</b>
---	---

## 4.10 Organisational Measures

- ⚠ Always keep this operating manual within easy reach and at the place of use of the lift table.
- ⚠ In addition to the operating manual, observe and instruct on generally applicable legal and other binding regulations for accident prevention and environmental protection.
- ⚠ Supplement the operating manual with further instructions, including supervisory and reporting duties, to take account of special operational features (e.g. with regard to work organisation, work processes, personnel employed).
- ⚠ Before starting work on the lift table, the person responsible for its operation must have read the operating instructions, especially the chapter "Safety Instructions". This applies in particular to personnel who only occasionally work on the lift table.
- ⚠ Check that work is carried out in a safety-conscious and hazard-conscious manner and in compliance with the operating manual.
- ⚠ When using additional machines on the lift table, read the respective operating instructions and keep them handy. Pay particular attention to the respective safety and hazard information.
- ⚠ In case of safety-relevant changes to the lift table or its operating behaviour, shut down the entire system immediately and report the fault to the responsible office/person.
- ⚠ Use personal protective equipment as necessary or required by regulations.
- ⚠ Do not make any modifications, additional attachments or conversions to the lift table without the manufacturer's approval! This will compromise safety and invalidate the manufacturer's warranty and any liability claim.
- ⚠ Spare parts must meet the technical requirements specified by the manufacturer. The exclusive use of original spare parts ensures this. Therefore, only use original spare parts from the manufacturer.
- ⚠ Observe the fire alarm and firefighting possibilities. Make the location and operation of fire extinguishers (fire class ABC) known. Do not use water!

## 4.11 Personnel Selection and Qualification - Basic Duties

- ⚠ The design and operation of the lift table is equally suitable for right- and left-handers.
- ⚠ The lift table is designed to be operated by a single person. Other persons in the vicinity of the lift table must keep a suitable safety distance.
- ⚠ Work on and with the lift table may only be carried out by reliable personnel. Observe the legal minimum age!
- ⚠ Only use trained or instructed personnel. Clearly define the responsibilities of the personnel for operating, setting up, maintaining and repairing!
- ⚠ Ensure that only authorised personnel work on the lift table.!
- ⚠ If personnel to be trained or apprenticed have to work on the lift table, this may only be done under the constant supervision of an experienced resp. qualified person.
- ⚠ Work on hydraulic equipment may only be carried out by authorised and trained personnel.

## 5 Technical Specifications

<b>Lift Table Type</b>	<b>HS 200 FH</b>
<b>Article number</b>	<b>180.100.00</b>
Special feature	aluminium lightweight construction
Standard table top material	3 mm thick aluminium sheet
Working platform dimensions <sup>1</sup>	1000 x 600 x 3 mm
Total height <sup>2</sup>	1010 mm
Effective stroke	610 mm
Construction height lift table	400 mm
Height adjustment	hydraulically
Control element for height	foot bar
Movable castors	4 pieces (∅ = 125 mm)
Parking brakes	2 pieces (longitudinally mounted)
Load capacity / lifting capacity	max. 200 kg
Net weight <sup>2</sup>	approx. 35 kg
Hydraulic power units	1 x lateral

### 5.1 Manufacturer and Nameplate

#### Manufacturer:

Reinhold Beck Maschinenbau GmbH  
 Im Grund 23  
 DE-72505 Krauchenwies (Germany)  
 Phone: +49 (0) 7576 / 962 978 - 0  
 Fax: +49 (0) 7576 / 962 978 - 90  
 Email: [info@beck-maschinenbau.de](mailto:info@beck-maschinenbau.de)

#### Nameplate:

The nameplate provides information about the characteristic values of your lift table:

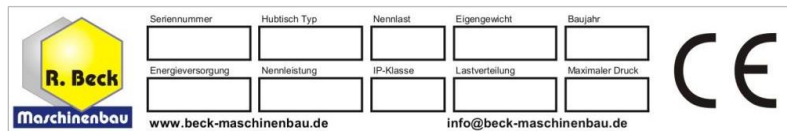

Figure 2: Nameplate

**Note:** Before using the unit in a way that deviates from the described suitability (see section ⇨ 4.2), it is essential to consult the manufacturer. Otherwise all warranty, liability and other claims for damages of the operator against the manufacturer will be voided!

<sup>1</sup> For basic model (optionally available table tops are larger, see chapter ⇨ 12).







<sup>2</sup> Specification refers to the basic model without optional table top.

## 6 Transport to the Installation Site

Only trained personnel may be used for the following work:

- Transport the lift table
- Unloading the lift table
- Check delivery condition of the lift table

### 6.1 Unloading the Lift Table

	<p><b><i>There is an increased risk of accidents when unloading and transporting the lift table! The lift table can fall or tip over due to its weight!</i></b></p>
	<p><b><i>Use only suitable and technically perfect lifting gear and suspension systems with an adequate lifting capacity of 500 kg. Only transport the lift table on level, solid ground!</i></b></p>
	<p><b><i>When placing the lift table, pay attention to the possible danger of crushing in the area of stationary objects around the lift table!</i></b></p>
	<p><b><i>Warning: Increased risk of injury and death! Never stand under the load when lifting and putting it down! Instruct bystanders to leave the danger zone!</i></b></p>
	<p><b><i>Warning: Increased risk of injury and death! Do not enter or climb onto the forklift platform during transport!</i></b></p>
	<p><b><i>Increased risk of crushing feet and toes! Wear steel-toed safety shoes!</i></b></p>

#### Unloading by forklift truck



- With the forks set appropriately, drive centrally into the designated places on the freight pallet on the longitudinal side of the lift table and lift carefully.
- Carefully lift the HS 200 from the truck. The weight of the lift table is approx. 35 kg (without accessories).

#### Check delivery condition

Check for completeness and transport damage. In case of transport damage or missing parts, document these immediately on the consignment note of the transport company. At the same time, inform the manufacturer of the situation.

#### Unpacking and placing

Unpack the lift table and remove the packing material. Lift the HS 200 from the transport pallet with a forklift. When doing so, drive under the centre of the long side of the lift table with appropriately adjusted forks and carefully lift slightly. Then lift carefully from the pallet, remove the pallet and set the lift table down on the ground.

	<p><b><i>Fire hazard! Do not smoke or light an open fire.</i></b></p>
	<p><b><i>Dispose of the packaging material in an environmentally friendly manner!</i></b></p>

#### Transport to the installation site

After unpacking, the lift table can be moved to the installation site either via its four swivel castors or using a suitable means of transport. If a forklift or lift truck is used for this purpose, the general safety regulations must be followed and observed.

## 6.2 Requirements for the Installation Site

The following guidelines apply with regard to space requirements, load-bearing capacity and the condition of the substrate:

- Space requirements: W x H x D = 1200 x 400 x 700 mm (with standard table top)  
W x H x D = 1350 x 430 x 820 mm (with optional table top, see ⇒ 12)
- Load capacity: Concrete of classification B 15
- Conditions: Level, smooth, non-slip and tilt-free

## 6.3 Temporary Storage

If the lift table is not put into operation immediately after delivery, it must be stored carefully in a protected place. Carefully cover the entire lift table so that neither dust nor moisture can penetrate.

### 6.3.1 Short Term Storage

- Dry environment
- Protect components at risk of corrosion
- Park in a stable place

### 6.3.2 Long Term Storage

- Dry environment
- Protect components at risk of corrosion
- Protect lift table from dirt
- Park in a stable place

## 6.4 Lashing on a Transport Vehicle

The lift table must be lashed to the loading area of the transport vehicle on a transport pallet for possible onward transport. For this purpose, at least two lashing straps with the appropriate load-bearing capacity must be used.

**The responsibility for safe loading is borne by the respective shipper!**



***A separate lashing strap must be used for each lashing and must be tensioned individually on the floor of the loading area of the vehicle! The pallet must also be secured against slipping.***

Please note the following when lashing in the transport vehicle:

- The loading area of the transport vehicle must always be clean and dry.
- The lashing straps used must be suitable for the total weight of the lift table (see chapter ⇒ 5).
- Fastening on the loading area is done by lashing down: This means that the transport pallet is secured by frictional locking. The load is pressed so firmly onto the loading surface that it can no longer slip. The clamping tool should have a high STF value at the frictional connection, e.g. long-lever ratchets.
- In addition, anti-slip mats should be used to provide even more safety.
- The ideal lashing angle ( $\alpha$ ) for tie-down lashing is 83° to and 90°. Therefore, the lashing straps should pull downwards approx. vertically. As the angle decreases, the pretensioning force of the lashing is reduced.
- Observe the permissible total weight of the transport vehicle.
- Ensure that the permissible axle loads of the transport vehicle are observed. The load must be distributed evenly on all axles of the vehicle.

## 7 Components and Controls



Figure 3: Components and controls

<b>Pos.</b>	<b>Description</b>	<b>Pos.</b>	<b>Description</b>
<b>1</b>	Foot bar for height adjustment	<b>5</b>	Lift table platform
<b>2</b>	Swivel castor (4 pieces)	<b>6</b>	Hydraulic cylinder
<b>3</b>	Parking brake (2 pieces)	<b>7</b>	Safety catch for maintenance
<b>4</b>	Lifting scissor		



Available options and other accessories see chapter ⇨ 15.





## 8 Installation and Commissioning

The lift table must be set up in a stable position so that there are no crushing or shearing points between the lift table and/or the load and objects in the vicinity. Therefore, ensure sufficient space around the lift table. It must be possible to carry out the intended work on the lift table or the load without obstruction.



The following installation and operating requirements must be observed:

-  The lift table must be integrated into the existing machinery in such a way that the basic safety requirements of the EU Machinery Directive 2006/42/EC are met. This must be checked and ensured by the operator of the lift table.
-  The environment must not be explosive.
-  This operating manual and any supplementary documents must be read carefully and understood. All safety instructions and regulations must be observed and complied.

## 9 Operation

	<b><i>Before operating the lift table, the operator must ensure that no hazards are caused by the movement of the lift table platform.</i></b>
	<b><i>Generally wear steel-toed safety shoes and suitable protective work clothing!</i></b>

### 9.1 Load and Unload the Lift Table

-  When loading or unloading the work platform, the load distribution according to section ⇒ 4.6 “Load Distribution and Influence on the Nominal Load” must be observed and complied with.
-  A load placed on the lift table must be secured with suitable measures against slipping, tipping over, rolling away and falling down. This is particularly necessary for loads that have an unstable position on the platform or that do not rest snugly on the lift table plate due to their shape and/or nature (e.g. rolling objects).

### 9.2 Moving the Lift Table via Swivel Castors

Before moving the lift table, release the two brakes (3) on the long side (see ⇒ Figure 4 on next page). Afterwards, it can be moved to the desired location. Before starting to work, lock the two brakes (3) again.

	<b><i>Before moving the lift table, the load must always be lowered completely. Furthermore, the load must be secured by suitable measures against slipping, tipping over, rolling away and falling down before the lift table is moved.</i></b>
---	--

### 9.3 Lifting and Lowering the Platform

	<b><i>Before the lift table platform is lifted, the lift table must be fixed in place by the two lockable brakes on the two front swivel castors.</i></b>
---	---

The procedure for height adjustment follows on the ⇒ next page.

**Tip:** If you want to use your lift table for a longer time at the same height position (without adjustment), you can additionally fix it mechanically with the safety catch (see section ⇒ 11.1).

### 9.3.1 Height Adjustment

 **When adjusting the height, make sure that there are no objects between the scissor construction under the platform and that the safety catch (⇒ 11.1) is unlocked.**

 **Be aware of the risk of crushing hands and fingers, especially when positioning downwards. Never reach into the scissors during height adjustment!**

The height adjustment of the lift table is based on the scissor principle. The hydraulic power is transmitted to the hydraulic cylinder via the foot pump, whereby the foot pump and hydraulic cylinder form a fixed unit. Before adjusting the height, first secure the lift table against rolling away with the two parking brakes (3).

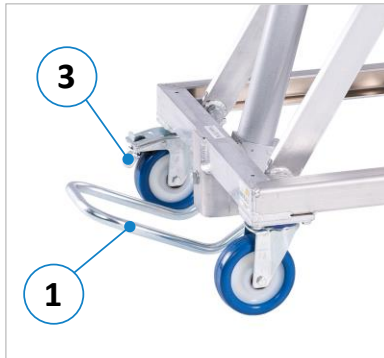



Figure 4: Foot bar and brakes

- By actuating the foot bar (1) downwards, the hydraulic cylinder reacts and transfers the force to the scissor unit. The platform moves upwards gradually with repeated actuation. After approx. 40 actuations the complete lifting height is reached.
- When the foot bar (1) is released, the movement stops and the working platform remains in this position. In order to adjust the lift table infinitely and exactly to the desired position, the foot bar (1) can be released at any point.
- Pulling up the foot bar (1) lowers the work platform for the duration of the actuation.

## 10 Troubleshooting

Repair and maintenance work may only be carried out by competent, trained and instructed personnel.

 **Repair work on mechanical and hydraulic components may only be carried out by authorised and trained personnel.**

Proceed systematically when searching for the cause of a malfunction. If you are unable to find the fault or to remedy the malfunction, contact our customer service department (phone: 0049 7576 / 962 978 - 0).

Before you call us, please follow these steps:

- Make a note of the information on the nameplate of your lift table (see ⇒ Figure 2).
- Keep these operating instructions and any supplementary documents at hand.



The more precisely you describe the fault to us, the better we can then remedy the situation.

### Possible Faults

Fault	Possible Cause	Remedy
Lift table does not lower completely to the bottom	Safety catch for maintenance is locked	→ Lift the platform little upwards and unlock the safety catch
	Object stuck in lift table scissors	→ Remove object
Platform cannot be lifted up.	Lift table is overloaded	→ Reduce load
	Hydraulic cylinder, foot pump or mechanics defective	→ Contact customer service

## 11 Maintenance and Repair

Maintenance and repair work may only be carried out by competent, trained and instructed personnel. If necessary, further operating instructions and/or additional documents must be observed.

  	<p><b>After maintenance or repair work on the lift table, always carry out a function test.</b></p> <ul style="list-style-type: none"> <li>• It is forbidden to reach under the lift table platform before it is secured with the safety catch (see ⇨ section 11.1).</li> <li>• Wear safety shoes with steel-toed caps.</li> <li>• Wear suitable protective clothing.</li> </ul>
---	--

	<p><b>Repair work on mechanical and hydraulic components may only be carried out by authorised and trained personnel.</b></p>
---	---

	<p><b>Before any maintenance and repair work is carried out, chapter ⇨ 4 "Safety" must be read carefully and observed.</b></p>
---	--

### 11.1 Safety Catch for Securing



Figure 5: Safety catch for securing

The safety catch is primarily used for securing during maintenance work that has to be carried out underneath the lift table platform. This mainly includes replacing the hydraulic cylinder.

Since the lift table can no longer be held when the cylinder is removed, it can fall dangerously. For this reason, the safety catch must generally be used during maintenance work in the scissor area and underneath the platform.

To secure the lift table platform, lock the safety catch (7) by folding it down (see ⇨ Figure 5).

#### 11.1.1 Replacing the Hydraulic Cylinder

Move the lift table upwards until the safety catch (7) can be folded down. Then fold down the safety catch to secure the platform (see previous section ⇨ 11.1). Subsequently lower the lift table until the safety catch is effective and the hydraulic cylinder is relieved resp. accessible for removal.

	<p><b>Stop! Do not work under the lift table platform until it is mechanically locked via the safety catch. Non-compliance can result in life-threatening injuries.</b></p>
---	---

### 11.2 Maintenance Intervals

Interval	Action
Daily	Check all components for damage and have them replaced by competent personnel if necessary. If you have any questions, please contact our support (phone: 0049 7576 / 962 978 - 0).
Monthly	Lubricate the castors and bearings a little.
Annual	Make and document annual inspection of the lift table according to regulations.

## 12 Optional Table Tops

The characteristics of the table top depend on the work process and the requirements of the working environment. Therefore, three different, attachable table tops are optionally available for individual processing forms and different requirements:

### 12.1 Table Top AW 100 Smooth



Figure 6: Table Top AW 100 Smooth

- Table top with smooth surface made of all-weather AW 100 material.
- The table top can be attached to the existing platform of the HS 200 scissor lift table.
- Platform size: 1250 x 800 x 21 mm
- Weight approx. 14 kg
- Art.-No. 200.100.00

### 12.2 Table Top Beech Multiplex



Figure 7: Table Top Beech-Multiplex

- Table top made of beech multiplex with smooth surface.
- The table top is coated with linseed oil and can be attached to the existing platform of the HS 200 scissor lift table.
- Platform size: 1250 x 800 x 30 mm
- Weight approx. 24 kg
- Art.-No. 200.101.00

### 12.3 Table Top Hole Grid Multiplex



Figure 8: Table Top Multiplex Hole Grid

- Table top made of beech-multiplex with smooth surface, hole grid plate (pitch = 100 mm) and a variety of optional accessories.
- The table top is coated with linseed oil and can be attached to the existing platform of the HS 200 scissor lift table.
- Platform size: 1250 x 800 x 30 mm
- Grid holes  $\varnothing$  22 mm
- Weight approx. 23 kg
- Art.-No. 200.102.00

You will find suitable clamps and supplementary accessories in the sections  $\Rightarrow$  15.1 and  $\Rightarrow$  15.1.1.

## 13 Decommissioning

- Before taking out of service, the platform of the lift table must be lowered completely.
- For recommissioning, observe chapter ⇒ 8 “Installation and commissioning “.
- For the final scrapping of the lift table, please refer to chapter ⇒ 14.

## 14 Disassembly and Scrapping

When dismantling and scrapping the lift table, the current EU regulations or the respective regulations and laws of the country of operation, which are prescribed for proper dismantling and disposal, must be observed. The aim is to dismantle the lift table and its various materials and components properly, to recycle all possible parts and to dispose of non-recyclable components in the most environmentally friendly way.

	<p><b>Please pay particular attention to</b></p> <ul style="list-style-type: none"> <li>• <i>the dismantling of the lift table in the working area</i></li> <li>• <i>proper dismantling of the lift table and accessories</i></li> <li>• <i>a safe and proper removal of the lift table</i></li> <li>• <i>proper separation of all components and materials.</i></li> </ul>
---	---

When dismantling and disposing the lift table, the laws and regulations in force at the place of use concerning health and environmental protection must be observed.

	<p><b>Remove all residues of oil, grease and other lubricants and have them disposed of properly by a qualified disposal company.</b></p>
--	---

When separating, disposing of or recycling the lift table materials, comply with the environmental protection laws in force at the place of use regarding the disposal of industrial solid waste toxic and hazardous waste.

	<ul style="list-style-type: none"> <li>• <i>Hoses and plastic parts as well as other components that are not made of metal must be dismantled and recycled or disposed of separately.</i></li> <li>• <i>Pneumatic and hydraulic parts such as valves, solenoid valves, pressure regulators, etc. must be removed and (if possible) recycled or otherwise disposed of in a qualified manner.</i></li> <li>• <i>Dismantle the base frame and all metal parts of the lift table and sort them according to material type. Metals can be melted down and recycled.</i></li> </ul>
---	---

In the event of improper disposal of lubricants, the following residual risks to the environment and health exist:

	<p><b>Pollution of the environment by seepage into groundwater or sewage system.</b></p>
---	--

	<p><b>Poisoning of the personnel contracted for the disposal.</b></p>
---	---

**Note:** The disposal of lubricants considered toxic and hazardous must be carried out in accordance with the regulations and laws in force at the respective place of use. Only qualified disposal companies that have the appropriate permits for the disposal of used oil and lubricants are to be commissioned with the disposal.

## 15 Options and Accessories

In the following tables you will find options and accessories that you can use to upgrade your lift table.

	<p><b>Only use the original accessories and spare parts specified by the manufacturer. The use of other accessories or spare parts may cause injury to persons and damage to the lift table. The manufacturer accepts no liability for any damage resulting from the use of non-prescribed accessories and spare parts or additional components from third parties!</b></p>
---	---

### 15.1 Table Tops

Article	Description	Art.-No.
<b>TABLE TOP AW 100 SMOOTH</b>	Suitable for HS 200, attached to platform. <i>Platform size = 1250 x 800 x 21 mm   Weight approx. 14 kg</i>	200.100.00
<b>TABLE TOP BEECH-MULTIPLY</b>	Suitable for HS 200, attached to platform, coated with linseed oil. <i>Platform size = 1250 x 800 x 30 mm   Weight approx. 24 kg</i>	200.101.00
<b>TABLE TOP HOLE GRID BEECH-MULTIPLY</b>	Suitable for HS 200, attached to platform, coated with linseed oil. <i>Platform size = 1250 x 800 x 30 mm   Grid holes <math>\varnothing</math> 22 mm   Hole grid pitch T = 100 mm   Weight approx. 23 kg</i>	200.102.00

More details and figures can be found in our [catalogue](#).

#### 15.1.1 Accessories for Table Top Hole Grid Beech-Multiplex

Article	Description	Art.-No.
<b>HORIZONTAL CLAMP</b>	Clamping spigot with trapezoidal internal thread, threaded spindle and thrust piece with protective cap. <i>Threaded spindle 40 mm adjustable   Weight approx. 1 kg</i>	200.607.22
<b>VERTICAL RAIL CLAMP 30 x 8.5 mm, FIXED PROJECTION</b>	For vertical workpiece clamping. <i>Projection = 120 mm   Clamping height max. 200 mm   Swivelling by 360°   Weight approx. 1 kg</i>	200.603.22
<b>VERTICAL RAIL CLAMP 22 x 8.5 mm, FIXED PROJECTION</b>	For vertical workpiece clamping. <i>Projection = 100 mm   Clamping height max. 200 mm   Swivelling by 360°   Weight approx. 1 kg</i>	200.710.22
<b>VERTICAL RAIL CLAMP 22 x 8.5 mm, VARIABLE PROJECTION</b>	For precise positioning, individual tensioning during vertical workpiece clamping. <i>Projection: 30 - 150 mm   Clamping height max. 200 mm   Swivelling by 360°   Weight approx. 1 kg</i>	200.711.22
<b>VERTICAL RAIL CLAMP 22 x 8.5 mm, FIXED PROJECTION, LEVER HANDLE WITH LATCHING MECHANISM</b>	The lever handle with latching mechanism offers dosed, fast and vibration-proof tensioning during vertical workpiece clamping. <i>Projection = 100 mm   Clamping height max. 200 mm   Swivelling by 360°   Weight approx. 1 kg</i>	200.712.22

Continuation see ⇨ next page

Continuation “15.1.1 Accessories for Table Top Hole Grid Beech-Multiplex”

Article	Description	Art.-No.
<b>VERTICAL RAIL CLAMP 22 x 8.5 mm, VARIABLE PROJECTION, LEVER HANDLE WITH LATCHING MECHANISM</b>	The lever handle with latching mechanism offers dosed, fast and vibration-proof tensioning during vertical workpiece clamping. <i>Projection = 100 mm   Clamping height max. 200 mm   Swivelling by 360°   Weight approx. 1 kg</i>	200.713.22
<b>ONE-HAND VERTICAL RAIL CLAMP, 11 X 5 MM</b>	For vertical workpiece clamping. <i>Projection = 70 mm   Clamping height max. 150 mm   Swivelling by 360°   Clamping force 60 kg   Weight approx. 1 kg</i>	200.714.22
<b>HORIZONTAL TOGGLE CLAMP</b>	With 1 grid bolt and safety mechanism for powerful and gentle clamping. <i>Span = 35 mm   Automatic adaptation = 13 mm   Clamping force 250 kg   Weight approx. 1 kg</i>	200.715.22
<b>VERTICAL QUICK CLAMP</b>	With 1 grid bolt and safety mechanism for powerful and gentle clamping. <i>Span = 60 mm   Automatic adaptation = 35 mm   Clamping force 250 kg   Weight approx. 1 kg</i>	200.716.22
<b>VICE WITH QUICK ADJUSTMENT</b>	With 2 grid bolts. <i>Jaw width = 100 mm   Span max. 100 mm   Weight approx. 4 kg</i>	200.609.22
<b>ROUND STOP PIN</b>	With milled contact surface as counterpart for fastening workpieces. The stop can also be used as direct resistance of the workpiece. <i>Spigot <math>\varnothing</math> = 40 / 22 mm   Length = 40 mm</i>	200.602.22
<b>SINGLE THRUST BEARING WITH 1 GRID BOLT AND SAFETY MECHANISM</b>	As thrust bearing for the angular gear clamp, for clamping and fixing workpieces with grid bolts and safety mechanism. <i>Weight approx. 1 kg</i>	200.601.22
<b>ANGULAR GEAR TENSIONER WITH 2 GRID BOLTS</b>	Provides secure footing in the grid hole plate and enables uniformly strong clamping. <i>Nutzhub = 130 mm   Pressure plate = 100 x 78 mm   Clamping force bis 500 kg   Total length = 260 mm   Weight approx. 4 kg</i>	200.608.22
<b>ANTI SLIP SUPPORT RAIL</b>	1 anti-slip support rail with 600 mm or 1200 mm length and 2 grid bolts. For all perforated grid plates with a hole diameter of 22 mm. For non-slip processing of objects without additional clamping. <i>Length = 600 oder 1200 mm   Weight approx. 2 resp. 3 kg</i>	600 mm long: 200.612.22 1200 mm long: 200.610.22
<b>CROSS EXTENSION RAIL WITH CARPET PAD<sup>3</sup></b>	1 cross extension rail with carpet support, can be fixed on the 30 mm thick table top for widening. <i>Length = 1300 mm   Extension widenable up to 1800 mm   Weight approx. 5 kg</i>	200.606.00
<b>BRUSH PLATE ELEMENTS<sup>3</sup></b>	Ideal support so that workpieces/panels rest gently and without scratches during machining. For screwing onto a wooden table top. <i>Format of the single plate = 499 x 99 mm   Bristle height = 15 mm   Bristle <math>\varnothing</math> = 0.4 mm   Load per m<sup>2</sup> approx. 20 kg   Weight approx. 8 kg   Packaging unit 1m<sup>2</sup></i>	200.500.00

More details and figures can be found in our [catalogue](#).

<sup>3</sup> **Note:** Can also be used on the 30 mm table top “Beech-Multiplex” (Art.-No. 200.101.00) without grid holes.

## EU - Declaration of Conformity

in accordance with the EU Machinery Directive 2006/42/EC Annex II A

The manufacturer,

Fa. Reinhold Beck  
Maschinenbau GmbH  
Im Grund 23  
DE-72505 Krauchenwies (Germany)  
Phone: 0049 - 7576 962 978 0  
Fax: 0049 - 7576 962 978 90

hereby declares that the manufactured machine

Model: **HS 200 FH**  
Type designation: Lift Table  
Serial number(s):  
Year of manufacture:

in the version provided complies with the EU Machinery Directive 2006/42/EC and the following further directives:

The following harmonised standards and instructions have been applied in manufacturing the machine:

- **EN ISO 12100:2010** Safety of machinery - General principles for design - Risk assessment and risk reduction
- **EN 1570-1:2011** Safety requirements for lifting tables

Name: Beck  
First name: Reinhold  
Position: Managing Director

Krauchenwies, 25.10.2021

-----  
Place and date



-----  
Signature