

TRANSLATION OF THE ORIGINAL VERSION



# Operating Manual

Foot-hydraulic and battery-hydraulic adjustable Scissor Lift Tables

Types HS 600 | FH and HS 600 | AH



*Valid for types:* HS 600 | FH and HS 600 | AH

**Reinhold Beck Maschinenbau GmbH**

Im Grund 23 | DE -72505 Krauchenwies

Tel.: +49 (0) 7576 / 962 978 - 0 | Fax: +49 (0) 7576 / 962 978 - 90

E-Mail: [info@beck-maschinenbau.de](mailto:info@beck-maschinenbau.de) | Web: <https://www.beck-maschinenbau.de>

# Table of Contents

1	Introduction.....	4
1.1	Legal Notice.....	4
1.2	Illustrations.....	4
2	Symbols.....	4
2.1	General Symbols.....	4
2.2	Symbols in Safety Instructions.....	5
3	General.....	6
3.1	Advantages.....	6
3.2	Applications.....	6
3.3	Target Group and Previous Experience.....	6
3.4	Requirements for the Operators.....	6
3.5	Accident Prevention.....	7
3.6	General Safety Regulations.....	7
3.7	Standard Equipment.....	7
3.8	Options and Accessories.....	7
4	Safety.....	8
4.1	Basic Safety Instructions.....	8
4.2	Application Area and Intended Use.....	8
4.3	Improper Use.....	8
4.4	Consequences in Case of Disregard.....	9
4.5	Conversions and Modifications of the Lift Table.....	9
4.6	Load Distribution and Influence on the Nominal Load.....	9
4.7	Hazardous Areas.....	10
4.8	Residual Risks.....	11
4.9	Observe the Environmental Protection Regulations.....	11
4.10	Organisational Measures.....	12
4.11	Personnel Selection and Qualification - Basic Duties.....	12
5	Technical Specifications.....	13
5.1	Manufacturer and Nameplate.....	13
6	Transport to the Installation Site.....	14
6.1	Unloading the Lift Table.....	14
6.2	Requirements for the Installation Site.....	15
6.3	Temporary Storage.....	15
6.3.1	Short Term Storage.....	15
6.3.2	Long Term Storage.....	15
6.4	Lashing on a Transport Vehicle.....	15
7	Components and Controls.....	16
7.1	Model HS 600   FH.....	16
7.2	Model HS 600   AH.....	17
8	Installation and Commissioning.....	18
9	Operation.....	18
9.1	Switch on Model HS 600   AH.....	18

9.2	Load and Unload the Lift Table.....	18
9.3	Moving the Lift Table via Swivel Castors .....	18
9.4	Lifting and Lowering the Platform .....	19
9.4.1	HS 600   FH .....	19
9.4.2	HS 600   AH.....	19
10	Measures after Operation .....	20
10.1	General Measures .....	20
10.2	Measures for battery-hydraulic Models (AH).....	20
11	Troubleshooting .....	21
12	Maintenance and Repair .....	22
12.1	Safety Catches for Securing.....	22
12.1.1	Replacing the Hydraulic Cylinder .....	22
12.2	Maintenance Intervals .....	22
13	Battery Charging Unit .....	23
13.1	CTEK MXS 5.0 - Operation Instructions .....	23
14	Decommissioning .....	29
15	Disassembly and Scrapping .....	29
16	Options and Accessories.....	30
16.1	Table Tops (Wood or Steel).....	30
16.2	Tilting Devices .....	31
16.3	Further Options and Accessories.....	31
16.4	Accessories for Model HS 600   AH.....	31
16.5	Extension Systems for Models without Vacuum .....	32
16.6	Accessories for Wood Hole Grid Panels .....	33
16.7	Accessories for Metal Hole Grid Panel (Art.-No. 200.208.00).....	34
16.8	Accessories for Steel Hole Grid Plate (Art.-No. 200.400.16 & 200.209.16) .....	35
	EU - Declaration of Conformity.....	36

## List of Figures

Figure 1:	Permissible load with load distribution .....	9
Figure 2:	Nameplate .....	13
Figure 3:	Components and controls of HS 600   FH .....	16
Figure 4:	Components and controls of HS 600   AH.....	17
Figure 5:	Main switch .....	18
Figure 6:	Height adjustment pedal .....	19
Figure 7:	Push button unit.....	19
Figure 8:	Secure main switch.....	20
Figure 9:	Safety catch for securing .....	22

### Revisions:

Revision	Autor	Modification	Date
001	AG	German original manual translated	12.11.2021

# 1 Introduction

The information in this operating manual enables safe, proper and economical operation of your lift table. Please observe all the explanations, notes and regulations

- to avoid dangers and malfunctions,
- to reduce repair costs and downtimes
- and to increase reliability and service life

of your lift table.

The operating manual must be read and used by each person entrusted with carrying out work with the lift table. This must be ensured by the operator. Further this manual as well as any appendices and additional documents must be kept easily accessible at the place of use of the lift table.

	<p><b><i>Ignorance or non-observance of these operating instructions may result in certain accident hazards during <u>handling</u> with the lift table. Before commissioning, this operating manual and any appendices and additional documents must be read thoroughly. All instructions, in particular the safety regulations, must be observed!</i></b></p> <p><b><i>Handling</i></b> the lift table in the sense of these instructions means</p> <ul style="list-style-type: none"> <li>• the installation and commissioning,</li> <li>• the operation and proper usage,</li> <li>• the influence on operating conditions, as well as</li> <li>• the maintenance, troubleshooting and repair.</li> </ul>
---	--

Apart from the operating manual and the legally binding accident prevention provisions applicable in the country and place of use, the recognized technical regulations for safe and proper work must also be observed.

## 1.1 Legal Notice



All contents of these operating instructions are subject to the rights of use and copyright of Reinhold Beck Maschinenbau GmbH. Any reproduction, modification, further use and publication in other electronic or printed media, as well as their online publication, requires the prior written consent of Reinhold Beck Maschinenbau GmbH.

## 1.2 Illustrations

All photos, figures and graphics contained in this document are for illustration and better understanding only and may differ from the current state of the product.

# 2 Symbols















## 2.1 General Symbols

<b>Symbol</b>	<b>Meaning</b>
	Indicates passages within this operating manual that must be particularly observed in order to prevent malfunctions or damage to the lift table.
	Refers to chapters, sections, or figures within this document.
	Refers to an external document or a third-party source.

## 2.2 Symbols in Safety Instructions

The lift table is designed and manufactured according to the current state of the art. Nevertheless, residual hazards may occur during handling. In this operating manual, possible dangers and residual risks are pointed out at appropriate places.

Safety instructions are provided with corresponding danger symbols which have the following meanings:

<b>Symbol</b>	<b>Safety Instruction</b>
	Reading and applying the operating manual is mandatory for the operating personnel. <i>Failure to abide by the following precautions could lead to serious or possibly fatal injury.</i>
	General danger symbol, which requires the highest attention! <i>Failure to observe may result in damage to the equipment, serious injury or even death.</i>
	This symbol warns of the dangers of electric voltage! <i>Failure to observe may result in damage to the equipment, serious injury or even death.</i>
	Reference to a prohibited zone under a lifted load! <i>Do not enter! There is an increased risk of injury or even death.</i>
	Reference to a prohibited zone on a platform! <i>Do not enter! There is an increased risk of injury or even death.</i>
	Reference to a possible crushing hazard! <i>Non-observance increases the risk of injury to hands and fingers!</i>
	Reference to a possible crushing hazard! <i>Non-observance increases the risk of injury to feet and toes!</i>
	Possible dangerous crushing hazard in the area of stationary objects! <i>Risk of personal injury and possibly additional equipment damage.</i>
	Reference to a possible hazard due to forklift traffic! <i>Non-observance can result in life-threatening injuries.</i>
	Reference to a possible danger under suspended loads! <i>Non-observance can result in life-threatening injuries.</i>
	Reference to possible tripping and slipping hazards on the floor! <i>Non-observance may result in minor or severe injuries.</i>
	Reference to possible environmental pollution! <i>Non-observance poses a risk of pollution of the environment and groundwater!</i>
	Reference to the obligation to wear safety shoes resp. protective gloves! <i>Non-observance may result in increased risk of injury to feet &amp; toes or hands &amp; fingers!</i>
	Fire hazard! Do not smoke and do not ignite open fire.
	Access for unauthorized persons prohibited! <i>Risk of personal injury and possibly additional equipment damage.</i>

## 3 General



***The operating manual must be read carefully and understood before handling the lift table! If anything is unclear, please contact the manufacturer.***

The ergonomic HS 600 scissor lift table has a high load capacity of max. 600 kg. With its 1900 x 740 mm support frame, this model is equipped for large-area table tops. The solid construction of square profiles and its mobility thanks to four swivel castors make it an indispensable assistant for countless applications in industry and trade, e.g. for maintenance, assembly and repair work.

Attachable and screwable optional table tops allow individual adaptation to different applications.

### 3.1 Advantages

- Back-friendly hydraulic height adjustment by foot (HS 600 | FH) or battery (HS 600 | AH)
- The sturdy single scissor design offers a long service life even under heavy loads
- The scissor principle ensures a high load-bearing capacity of max. 600 kg
- Mobility thanks to four swivel castors ensures flexible and versatile use
- Uniform adjustment to height, even under uneven load distribution
- Individual application areas can be realised with different table tops
- High-quality, side-mounted hydraulic unit

### 3.2 Applications

The lift table can be used for all work corresponding to its intended use in section ⇒ 4.2. It is suitable for use as work equipment for transporting, lifting and lowering loads as well as a height-adjustable assembly table. Typical areas of application are workplaces in manufacturing, assembly and maintenance, where precise height adjustment for ergonomic working as well as high flexibility and mobility are of particular importance.

The lift table must not be used for work that does not correspond to its intended use (see section ⇒ 4.2).

### 3.3 Target Group and Previous Experience

This operating manual is intended for the operating and maintenance personnel of the lift table. The operating personnel is to be determined by the operator and must further meet the following requirements:

- Basic technical and mechanical knowledge as well as knowledge of the associated technical terms
- Reading and understanding these operating and maintenance instructions

In order to acquire the knowledge required to operate this lift table, the operator must ensure the following measures:

- Product training for every operator (also possible external personnel)
- Regular safety instruction

### 3.4 Requirements for the Operators

- ⚠ The operator is responsible for the safe use of the lift table!
- ⚠ The lift table may only be operated by trained personnel who have also read this manual.
- ⚠ Inspection, maintenance, cleaning and repair may only be performed by technical specialists with product-specific training and mechanical and/or electrical training.
- ⚠ Specialists with product-specific training are to be commissioned and held responsible for planning and checking the work.
- ⚠ The national protective regulations for employees must be observed
- ⚠ The legal minimum age must be observed.

### 3.5 Accident Prevention

To avoid accidents, the following rules must be observed for operation:

- ⚠ Prevent unauthorized persons from gaining access to the lift table.
- ⚠ Keep unauthorized persons away from the danger areas.
- ⚠ Repeatedly inform present other persons about existing residual risks (see section ⇒ 4.8 "Residual Risks").
- ⚠ Conduct and record regular training & instruction for persons who must be in the area of the lift table.
- ⚠ New employees must be trained internally to work on a lift table and this training must be documented.
- ⚠ It is not permitted to enter the lift table platform or to transport resp. lift persons.

### 3.6 General Safety Regulations

In general, the following safety regulations and obligations apply when handling the lift table:

- ⚠ The lift table may only be operated when it is in perfect working order.
- ⚠ It is prohibited to remove, modify or bypass any protective, safety or monitoring equipment.
- ⚠ It is forbidden to modify or alter the lift table without the written approval of the manufacturer / supplier.
- ⚠ Faults or damage must be reported to the operator immediately, eliminated without delay and repaired if necessary.
- ⚠ Repair and maintenance work on electrical and hydraulic components (e.g. battery or hydraulic cylinders) may only be performed by authorized and trained personnel.
- ⚠ Repair and maintenance work may only be carried out if the lift table has been secured with the safety catches beforehand (see section ⇒ 12.1).
- ⚠ Maintenance must be carried out and documented in accordance with the maintenance instructions.
- ⚠ For repairs, only original spare parts from the manufacturer may be used.
- ⚠ Only instructed, trained or qualified persons may work on the lift table.
- ⚠ For the operation of the lift table, the respective national safety regulations for employees as well as the national safety and accident prevention regulations apply.

### 3.7 Standard Equipment

- Four swivel castors for mobile use and two parking brakes on the left longitudinal side
- Uniform height adjustment even with uneven load distribution or eccentric loading
- Stepless foot-hydraulically (FH) or battery-hydraulically (AH) height adjustment
- Safety catches for securing during maintenance work
- The two basic models are supplied without table top
- Sturdy single-scissor construction
- High-quality hydraulic unit
- Versatile and flexible use
- CE-compliant design

### 3.8 Options and Accessories

- Optionally selectable table tops can be found in chapter ⇒ 16 "Options and Accessories".

## 4 Safety

### 4.1 Basic Safety Instructions

Lift tables can be dangerous if used improperly. Therefore, observe the safety instructions listed in this chapter and the accident prevention regulations of your employer's liability insurance association!



***The manufacturer accepts no liability for damage and malfunctions resulting from failure to observe these operating instructions.***

### 4.2 Application Area and Intended Use

The hydraulically adjustable lift tables of the HS series conform to the Machinery Directive 2006/42/EC and are therefore suitable as technical equipment for both industrial and commercial applications as well as for training purposes in educational institutions.



***Improper use can lead to danger to persons and to a defect or damage to the lift table.***

- ⚠ The lift table is primarily intended for operation in covered indoor areas, but it can also be used outdoors for loading and unloading purposes (e.g. from the service vehicle to the place of use).
- ⚠ Work on the lift table may only be performed at sufficiently illuminated workplaces.
- ⚠ The lift table is intended for processing, equipping, assembling and transporting assemblies, workpieces and similar components as well as for lifting, lowering and moving loads.
- ⚠ The lift table may only be used on horizontal floors for lifting loads.
- ⚠ The lift table may only be moved when the load is lowered.
- ⚠ The lift table must be positioned freely in the room when lifting and lowering. This means that no shearing or crushing edges may be caused by the movement of the lift table.
- ⚠ The maximum load (see ⇒ 5 "Technical Specifications") with load center in the middle of the lift table must not be exceeded. If the lift table is loaded unevenly, outside the load center of gravity, the load capacity is reduced to up to 33 % of the maximum permitted load capacity (see ⇒ Figure 1).
- ⚠ The lift table is not intended for moving and transporting persons.
- ⚠ The lift table must not be operated in potentially explosive working areas.
- ⚠ Any other use is considered improper and prohibited.

### 4.3 Improper Use

Improper use is when the lift table is used for purposes other than those prescribed in this operating manual and in section ⇒ 4.2, for example

- ⚠ Use and application for private or non-commercial purposes,
- ⚠ Use in disregard of the regulations in the operating manual,
- ⚠ use after unauthorized conversions or modifications,
- ⚠ Exceeding the maximum permissible load (see ⇒ 5 "Technical Specifications")
- ⚠ Transporting or conveying persons with the lift table
- ⚠ Entering the lift table

In case of improper use of the lift table, any warranty, liability and other claims for damages of the operator against the manufacturer are excluded!



## 4.4 Consequences in Case of Disregard

If the lift table is not operated, maintained or repaired in accordance with the safety regulations, not as intended, improperly or in an abusive manner, the following will result:

- ⚠ Dangers to the health of the operating personnel
- ⚠ Dangers to the lift table and objects in its vicinity
- ⚠ Impairment of the lift table function

In case of improper use of the lift table, any warranty, liability and other claims for damages of the operator against the manufacturer are excluded!

## 4.5 Conversions and Modifications of the Lift Table

- ⚠ Only use the lift table in its original condition, i.e. as delivered!
- ⚠ The components of the lift table must not be changed in their type and condition.
- ⚠ Only original spare parts and accessories from the manufacturer (see ⇨ 16) may be used.
- ⚠ Deviations are not permitted.

	<p><b><i>Unauthorized modifications or conversions by the operator, without the written consent of the manufacturer, are prohibited. This excludes any warranty, liability and other claims for damages by the operator against the manufacturer!</i></b></p>
---	---

## 4.6 Load Distribution and Influence on the Nominal Load

The nominal, maximum permissible load of 600 kg is based on a load evenly distributed on the lift table platform. If the load cannot be distributed evenly on the platform, the maximum permissible load must be reduced according to the figures below.

Figure 1: Permissible load with load distribution

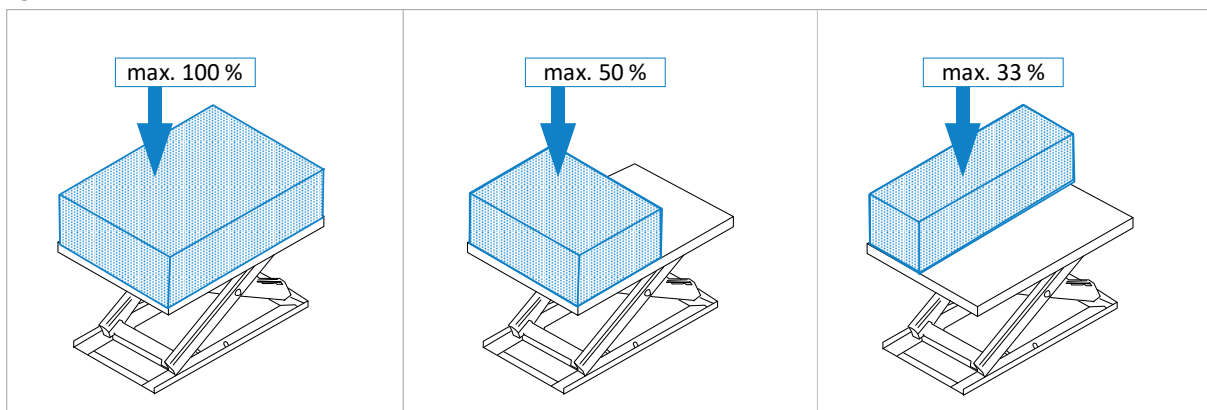

### Even distribution

Load is evenly distributed over the entire platform area  
 → 100 % of the nominal load is permissible.





### Uneven distribution

Load is distributed over half of the platform in transverse direction  
 → 50 % of the nominal load is permissible.

### Uneven distribution















Load is distributed over half of the platform in longitudinal direction  
 → 33 % of the nominal load is permissible.

## 4.7 Hazardous Areas

Source	Area	Cause	Risk	Prevention
<b>Foot pump</b> 	<i>HS 600   FH only:</i> On the foot pedal for height adjustment	Slipping off the foot pedal	Injuries to feet and legs	Keep foot pedal and shoes dry Wear work shoes with non-slip soles
<b>Mechanics</b> 	Lifting scissor / Subframe	Crushing and shearing points	Loss of limbs, crushing of hands, increased risk of injury and even death	Do not reach under the tabletop or into the scissors during operation and do not move your body into this area Before maintenance work, always lock the safety catch to secure the platform first (see section ⇒ 12.1)
<b>Hydraulic system</b> 	On hydraulic cylinders and all oil-bearing parts, seals and lines	Oil spraying out with high pressure in case of damaged cylinder or seals	Injuries and poisoning of the eyes	Wear safety goggles or face shield Repair damaged parts and/or seals immediately (only qualified personnel!)
<b>Electrics</b> 	<i>HS 600   AH only:</i> At the mains connection and the supply line of the battery charger as well as at the pole terminals of the 12 V battery	Electrical voltage (230 VAC) at the battery charger as well as high currents at the battery pole terminals and further cables	Electric shocks with increased risk of injury up to death	Avoid moisture Have defective parts / insulation repaired immediately (only qualified personnel!) Do not touch energised components Switch off the main switch during all maintenance and repair work

## 4.8 Residual Risks

The lift table is built according to the latest state of the art and the recognised safety rules. Nevertheless, the use of the lift table may cause danger to life and limb of the user or third parties or damage to the lift table and other equipment. Due to the construction of the lift table, the following residual risks can occur even when used as intended and despite compliance with all relevant safety regulations:

	Reading and applying the operating manual is mandatory for the operating personnel.
	Be alert to possible crushing hazards: a) when transporting the lift table by forklift truck: between forks & pallet / lift table b) when picking up the lift table: between lift table / pallet and floor c) when lowering the lift table: between lift table and fixed equipment
	Be alert to possible crushing hazards when lowering the lift table (from the cargo pallet to the floor) with a forklift truck or overhead crane.
	Be aware of the danger from falling objects such as workpieces, tools or similar. Therefore, wear safety shoes, especially when transporting and setting down the lift table.
	It is strictly forbidden to "ride along" with the lift table during a lifting operation (by means of a forklift truck or overhead crane). There is a high risk of falling!
	It is strictly forbidden to enter or climb onto the lift table during a lifting operation (by means of a forklift truck or overhead crane). There is a high risk of falling!
	Increased risk of injury or even death. Entering the danger zone under a lifted load during transport or installation by means of a forklift truck is prohibited!
	Increased risk of injury or even death. It is forbidden to enter the forklift platform during transport or installation!
	Unauthorised persons are not allowed to enter the lift table installation area (responsibility of the operator).
	Stop! Do not work under the lift table platform until it is mechanically locked via the safety catch. Non-compliance can result in life-threatening injuries.
	Danger of electric shock on models with battery-operated hydraulic height adjustment! Work on the electrical components may only be carried out by qualified personnel.
	Be aware of possible tripping and slipping hazards on the floor. Prevent possible hazards by keeping the floor dry and clean and by using anti-slip floor coverings around the lift table.
	Acute danger of crushing underneath the table top! Never reach into the shears and never move your body into this area! There is an increased risk of accidents with loss of limbs or even death.
	When using additional machines on the lift table, first read the respective operating instructions and comply with the specified safety regulations.
	Be aware of the fire hazard during the processing of wood due to wood dust, in connection with flying sparks and/or open fire!

## 4.9 Observe the Environmental Protection Regulations

During all work with the lift table, the environmental protection regulations, obligations and laws for waste avoidance and proper recycling and/or disposal applicable at the place of use must be observed. This applies in particular to installation, repair and maintenance work involving substances that could pollute the groundwater (e.g. hydraulic oils and cleaning agents and liquids containing solvents). In any case, prevent them from seeping into the ground or entering the sewage system.

	<b>Store and transport the above-mentioned hazardous substances only in suitable containers. Avoid leakage of hazardous substances by using suitable collection containers. Ensure that the above-mentioned substances are disposed of by a qualified disposal company.</b>
---	---

## 4.10 Organisational Measures

- ⚠ Always keep this operating manual within easy reach and at the place of use of the lift table.
- ⚠ In addition to the operating manual, observe and instruct on generally applicable legal and other binding regulations for accident prevention and environmental protection.
- ⚠ Supplement the operating manual with further instructions, including supervisory and reporting duties, to take account of special operational features (e.g. with regard to work organisation, work processes, personnel employed).
- ⚠ Before starting work on the lift table, the person responsible for its operation must have read the operating instructions, especially the chapter "Safety Instructions". This applies in particular to personnel who only occasionally work on the lift table.
- ⚠ Check that work is carried out in a safety-conscious and hazard-conscious manner and in compliance with the operating manual.
- ⚠ When using additional machines on the lift table, read the respective operating instructions and keep them handy. Pay particular attention to the respective safety and hazard information.
- ⚠ In case of safety-relevant changes to the lift table or its operating behaviour, shut down the entire system immediately and report the fault to the responsible office/person.
- ⚠ Use personal protective equipment as necessary or required by regulations.
- ⚠ Do not make any modifications, additional attachments or conversions to the lift table without the manufacturer's approval! This will compromise safety and invalidate the manufacturer's warranty and any liability claim.
- ⚠ Spare parts must meet the technical requirements specified by the manufacturer. The exclusive use of original spare parts ensures this. Therefore, only use original spare parts from the manufacturer.
- ⚠ Observe the fire alarm and firefighting possibilities. Make the location and operation of fire extinguishers (fire class ABC) known. Do not use water!

## 4.11 Personnel Selection and Qualification - Basic Duties

- ⚠ The design and operation of the lift table is equally suitable for right- and left-handers.
- ⚠ The lift table is designed to be operated by a single person. Other persons in the vicinity of the lift table must keep a suitable safety distance.
- ⚠ Work on and with the lift table may only be carried out by reliable personnel. Observe the legal minimum age!
- ⚠ Only use trained or instructed personnel. Clearly define the responsibilities of the personnel for operating, setting up, maintaining and repairing!
- ⚠ Ensure that only authorised personnel work on the lift table!
- ⚠ If personnel to be trained or apprenticed have to work on the lift table, this may only be done under the constant supervision of an experienced resp. qualified person.
- ⚠ Work on hydraulic equipment may only be carried out by authorised and trained personnel.
- ⚠ Work on the electrical equipment of the lift table model HS 600 | AH may only be carried out by a qualified electrician or by instructed persons under the direction and supervision of a qualified electrician in accordance with the electrotechnical regulations.

## 5 Technical Specifications

<i>Lift Table Type</i> <i>Article number</i>	<i>HS 600   FH</i> <i>193.100.00</i>	<i>HS 600   AH</i> <i>193.100.00 + 200.350.00</i>
Special feature	foot-hydraulic height adjustment	battery-hydraulic height adjustment
Table top	none (option)	none (option)
Support frame dimensions <sup>1</sup>	1900 x 740 mm	1900 x 740 mm
Total height <sup>2</sup>	1010 mm	1010 mm
Effective stroke	610 mm	610 mm
Height (without table top)	400 mm	400 mm
Height adjustment	hydraulically	hydraulically
Control element for height	foot pedal	push button unit (removable)
Movable castors	4 pieces (∅ = 125 mm)	4 pieces (∅ = 125 mm)
Parking brakes	2 pieces (longitudinally mounted)	2 pieces (longitudinally mounted)
Load capacity / lifting capacity	max. 600 kg	max. 600 kg
Total stroke reached after	approx. 100 pumping operations	approx. 7 s Key actuation
Net weight <sup>2</sup>	approx. 170 kg	approx. 215 kg
Hydraulic power units	1 x lateral	1 x lateral
Battery technology	-	Lead gel, maintenance-free
Battery output voltage	-	12 VDC
Battery capacity	-	26 Ah
Battery operating temperature	-	-15 ... +40° C
Battery charger manufacturer	-	CTEK (manual see ⇒ 0)
Battery charger connection	-	230 VAC / 50 Hz (European standard connector)

### 5.1 Manufacturer and Nameplate

#### Manufacturer:

Reinhold Beck Maschinenbau GmbH  
Im Grund 23  
DE-72505 Krauchenwies (Germany)  
Phone: +49 (0) 7576 / 962 978 - 0  
Fax: +49 (0) 7576 / 962 978 - 90  
Email: [info@beck-maschinenbau.de](mailto:info@beck-maschinenbau.de)

#### Nameplate:

The nameplate provides information about the characteristic values of your lift table:

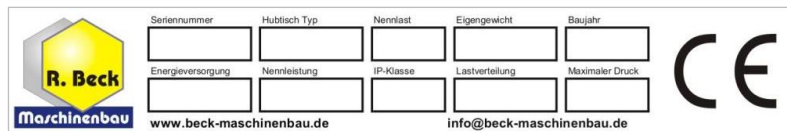

Figure 2: Nameplate

**Note:** Before using the unit in a way that deviates from the described suitability (see section ⇒ 4.2), it is essential to consult the manufacturer. Otherwise all warranty, liability and other claims for damages of the operator against the manufacturer will be voided!

<sup>1</sup> Frame construction without table top (optionally available table tops are larger, see section ⇒ 16).







<sup>2</sup> Specification refers to the basic model without optional table top.

## 6 Transport to the Installation Site

Only trained personnel may be used for the following work:

- Transport the lift table
- Unloading the lift table
- Check delivery condition of the lift table

### 6.1 Unloading the Lift Table

	<p><b><i>There is an increased risk of accidents when unloading and transporting the lift table! The lift table can fall or tip over due to its weight!</i></b></p>
	<p><b><i>Use only suitable and technically perfect lifting gear and suspension systems with an adequate lifting capacity of 500 kg. Only transport the lift table on level, solid ground!</i></b></p>
	<p><b><i>When placing the lift table, pay attention to the possible danger of crushing in the area of stationary objects around the lift table!</i></b></p>
	<p><b><i>Warning: Increased risk of injury and death! Never stand under the load when lifting and putting it down! Instruct bystanders to leave the danger zone!</i></b></p>
	<p><b><i>Warning: Increased risk of injury and death! Do not enter or climb onto the forklift platform during transport!</i></b></p>
	<p><b><i>Increased risk of crushing feet and toes! Wear steel-toed safety shoes!</i></b></p>

#### Unloading by forklift truck



- With the forks set appropriately, drive centrally into the designated places on the freight pallet on the longitudinal side of the lift table and lift carefully.
- Carefully lift the HS 600 from the truck. The net weight is approx. 170 kg (FH) resp. approx. 215 kg (AH).

#### Check delivery condition

Check for completeness and transport damage. In case of transport damage or missing parts, document these immediately on the consignment note of the transport company. At the same time, inform the manufacturer of the situation.

#### Unpacking and placing

Unpack the lift table and remove the packing material. Lift the HS 600 from the transport pallet with a forklift. When doing so, drive under the centre of the long side of the lift table with appropriately adjusted forks and carefully lift slightly. Then lift carefully from the pallet, remove the pallet and set the lift table down on the ground.

	<p><b><i>Fire hazard! Do not smoke or light an open fire.</i></b></p>
	<p><b><i>Dispose of the packaging material in an environmentally friendly manner!</i></b></p>

#### Transport to the installation site

After unpacking, the lift table can be moved to the installation site either via its four swivel castors or using a suitable means of transport. If a forklift or lift truck is used for this purpose, the general safety regulations must be followed and observed.

## 6.2 Requirements for the Installation Site

The following guidelines apply with regard to space requirements, load-bearing capacity and the condition of the substrate:

- Space requirements: W x H x D = 1010 x 420 x 2010 mm (with optional table top)
- Load capacity: Concrete of classification B 15
- Conditions: Level, smooth, non-slip and tilt-free

## 6.3 Temporary Storage

If the lift table is not put into operation immediately after delivery, it must be stored carefully in a protected place. Carefully cover the entire lift table so that neither dust nor moisture can penetrate.

### 6.3.1 Short Term Storage

- Dry environment
- Protect components at risk of corrosion
- Park in a stable place

### 6.3.2 Long Term Storage

- Dry environment
- Protect components at risk of corrosion
- Protect lift table from dirt
- Park in a stable place

## 6.4 Lashing on a Transport Vehicle

The lift table must be lashed to the loading area of the transport vehicle on a transport pallet for possible onward transport. For this purpose, at least two lashing straps with the appropriate load-bearing capacity must be used.

**The responsibility for safe loading is borne by the respective shipper!**

	<p><b><i>A separate lashing strap must be used for each lashing and must be tensioned individually on the floor of the loading area of the vehicle! The pallet must also be secured against slipping.</i></b></p>
---	---

Please note the following when lashing in the transport vehicle:

- The loading area of the transport vehicle must always be clean and dry.
- The lashing straps used must be suitable for the total weight of the lift table (see chapter ⇨ 5).
- Fastening on the loading area is done by lashing down: This means that the transport pallet is secured by frictional locking. The load is pressed so firmly onto the loading surface that it can no longer slip. The clamping tool should have a high STF value at the frictional connection, e.g. long-lever ratchets.
- In addition, anti-slip mats should be used to provide even more safety.
- The ideal lashing angle ( $\alpha$ ) for tie-down lashing is 83° to and 90°. Therefore, the lashing straps should pull downwards approx. vertically. As the angle decreases, the pretensioning force of the lashing is reduced.
- Observe the permissible total weight of the transport vehicle.
- Ensure that the permissible axle loads of the transport vehicle are observed. The load must be distributed evenly on all axles of the vehicle.

## 7 Components and Controls

### 7.1 Model HS 600 | FH

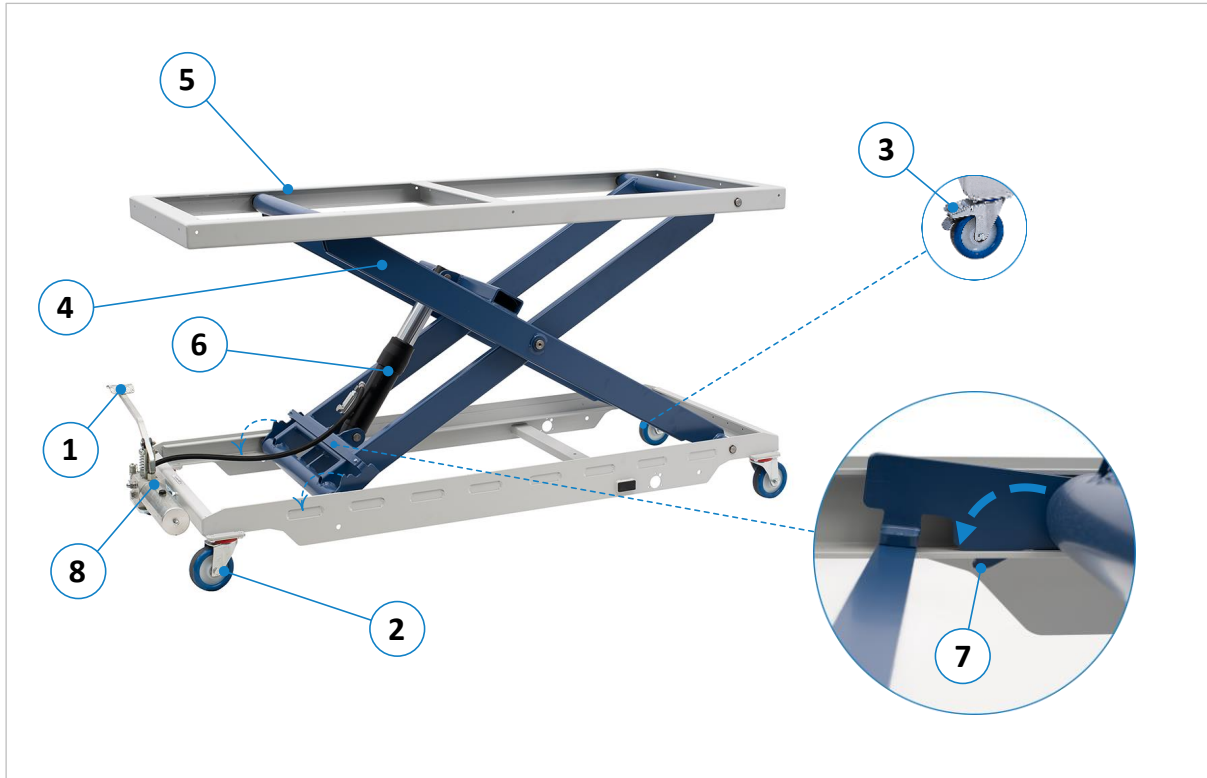

Figure 3: Components and controls of HS 600 | FH

<b>Pos.</b>	<b>Description</b>	<b>Pos.</b>	<b>Description</b>
<b>1</b>	Foot pedal for height adjustment	<b>5</b>	Support frame
<b>2</b>	Swivel castor (4 pieces)	<b>6</b>	Hydraulic cylinder
<b>3</b>	Parking brake (2 pieces)	<b>7</b>	Safety catches for maintenance
<b>4</b>	Lifting scissor	<b>8</b>	Hydraulic pump with tank

Available options and other accessories see chapter ⇨ 16.



## 7.2 Model HS 600 | AH

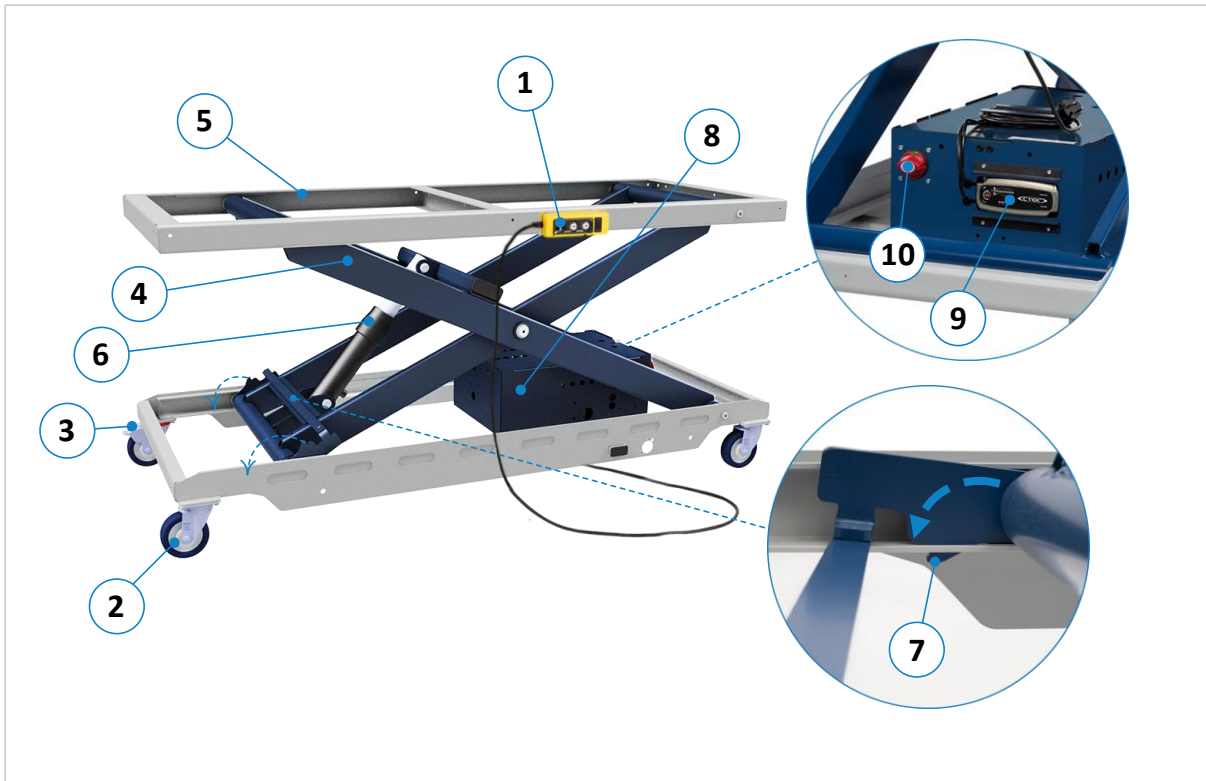

Figure 4: Components and controls of HS 600 | AH

<b>Pos.</b>	<b>Description</b>	<b>Pos.</b>	<b>Description</b>
<b>1</b>	Push-button unit for height adjustment	<b>6</b>	Hydraulic cylinder
<b>2</b>	Swivel castor (4 pieces)	<b>7</b>	Safety catches for maintenance
<b>3</b>	Parking brake (2 pieces)	<b>8</b>	Battery box
<b>4</b>	Lifting scissor	<b>9</b>	Battery charging unit
<b>5</b>	Support frame	<b>10</b>	Main switch

Available options and other accessories see chapter ⇒ 16.



## 8 Installation and Commissioning

The lift table must be set up in a stable position so that there are no crushing or shearing points between the lift table and/or the load and objects in the vicinity. Therefore, ensure sufficient space around the lift table. It must be possible to carry out the intended work on the lift table or the load without obstruction.

The following installation and operating requirements must be observed:

- ⚠ The lift table must be integrated into the existing machinery in such a way that the basic safety requirements of the EU Machinery Directive 2006/42/EC are met. This must be checked and ensured by the operator of the lift table.
- ⚠ The environment must not be explosive.
- ⚠ This operating manual and any supplementary documents must be read carefully and understood. All safety instructions and regulations must be observed and complied.

## 9 Operation

	<b><i>Before operating the lift table, the operator must ensure that no hazards are caused by the movement of the lift table platform.</i></b>
	<b><i>Generally wear steel-toed safety shoes and suitable protective work clothing!</i></b>

### 9.1 Switch on Model HS 600 | AH



Figure 5: Main switch

Before working with the battery-hydraulic lift table "AH", ensure that

- a) the battery is in a charged state
- b) the main switch (10) is in the "ON" position

	<b><i>After finishing work or during maintenance, the main switch (10) must generally be switched off.</i></b>
---	--

After completing the work, please follow the supplementary instructions in ⇒ 10.2.

### 9.2 Load and Unload the Lift Table

- 👉 When loading or unloading the work platform, the load distribution according to section ⇒ 4.6 "Load Distribution and Influence on the Nominal Load" must be observed and complied with.
- 👉 A load placed on the lift table must be secured with suitable measures against slipping, tipping over, rolling away and falling down. This is particularly necessary for loads that have an unstable position on the platform or that do not rest snugly on the lift table plate due to their shape and/or nature (e.g. rolling objects).

### 9.3 Moving the Lift Table via Swivel Castors

Before moving the lift table, release the two brakes on the longitudinal side. Afterwards, it can be moved to the desired location. Before starting to work, lock the two brakes again.

	<b><i>Before moving the lift table, the load must always be lowered completely. Furthermore, the load must be secured by suitable measures against slipping, tipping over, rolling away and falling down before the lift table is moved.</i></b>
---	--

## 9.4 Lifting and Lowering the Platform



**Before the lift table platform is lifted, the lift table must be fixed in place by the two lockable brakes on the two front swivel castors.**

**Tip:** If you want to use your lift table for a longer time at the same height position (without adjustment), you can additionally fix it mechanically with the safety catch (see section ⇒ 12.1).



**When adjusting the height, make sure that there are no objects between the scissor construction under the platform and that the safety catches (⇒ 12.1) are unlocked.**



**Be aware of the risk of crushing hands and fingers, especially when positioning downwards. Never reach into the scissors during height adjustment!**

The height adjustment of the lift table is based on the scissor principle. The hydraulic power is transmitted to the hydraulic cylinder via the foot pump.

### 9.4.1 HS 600 | FH

Before adjusting the height, first secure the lift table against rolling away with the two parking brakes.



Figure 6: Height adjustment pedal

- By actuating the foot pedal (1) downwards, the hydraulic cylinder reacts and transfers the force to the scissor unit. The platform moves upwards gradually with repeated actuation. After approx. 100 actuations the complete lifting height is reached.
- When the foot pedal (1) is released, the movement stops and the working platform remains in this position. In order to adjust the lift table infinitely and exactly to the desired position, the foot pedal (1) can be released at any point.
- Pulling up the foot pedal (1) lowers the work platform for the duration of the actuation.

### 9.4.2 HS 600 | AH

Before adjusting the height, first secure the lift table against rolling away with the two parking brakes.



Figure 7: Push button unit

- The height of the table top is adjusted using the removable push-button unit (⇒ Figure 7) which can be magnetically attached to the support frame.
- The platform can be positioned upwards with the ▲ button and downwards with the ▼ button.
- The battery hydraulics are controlled according to the dead man's principle, i.e. the lift table moves in the desired direction as long as one of the two buttons is pressed. As soon as the button is released, the table stops and remains in this position.

#### 9.4.2.1 Accessories for the battery unit

As an alternative to the wired push button unit, a radio control for the battery hydraulics is available, which enables completely wireless operation of the height adjustment (Art.-No. 190.151.00).

## 10 Measures after Operation

### 10.1 General Measures

Additional electrical components (e.g. machines lying on the lift table) must be switched off after finishing work and also disconnected from the mains by unplugging the power cable. Furthermore, the lift table must be secured against unauthorised use. The following options are available for this purpose:

- Lock away or park in such a way that unauthorised persons have no access to the lift table.
- Secure the lift table by means of a lock chain or wire rope to prevent unauthorised movement.
- Place a prohibition sign on the platform to prevent unauthorised use.
- For battery-operated hydraulic AH models, pull off the main switch handle (see next section ⇒ 10.2)

### 10.2 Measures for battery-hydraulic Models (AH)

After the lift table platform has been lowered completely and the applied load has been removed

→ **Switch off the battery hydraulics via the main switch (10)**

→ **Connect the charging cable of the battery charger to 230 VAC**

(charging is also possible when the main switch is turned off).

	<p><b><i>A well and fully charged battery allows effective operation throughout the working day.</i></b></p>
---	--

To prevent unauthorised use of the lift table, the rotary handle of the main switch (**10**) can easily be pulled off. The procedure is as follows:

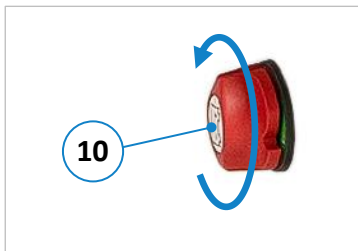



Figure 8: Secure main switch

- Move the main switch handle to the "OFF" position by turning it in the direction of the arrow shown in ⇒ Figure 8.
- Then turn the main switch handle again by approx. 45° in the same direction (against a slight resistance).
- Now the main switch handle can be removed to the front.

To replace the main switch handle, reverse the previous procedure. After the coded installation, the main switch handle must be pressed against the housing before it is turned.

	<p><b><i>The lift table should not be used while the batteries are charging.</i></b></p>
---	--

# 11 Troubleshooting

Repair and maintenance work may only be carried out by competent, trained and instructed personnel.

	<b><i>Repair work on mechanical and hydraulic components may only be carried out by authorised and trained personnel.</i></b>
---	---

Proceed systematically when searching for the cause of a malfunction. If you are unable to find the fault or to remedy the malfunction, contact our customer service department (phone: 0049 7576 / 962 978 - 0).

Before you call us, please follow these steps:

- Make a note of the information on the nameplate of your lift table (see ⇨ Figure 2).
- Keep these operating instructions and any supplementary documents at hand.

The more precisely you describe the fault to us, the better we can then remedy the situation.

## General Faults

Fault	Possible Cause	Remedy
Lift table does not lower completely to the bottom	Safety catch for maintenance is locked	→ Lift the platform little upwards and unlock the safety catch
	Object stuck in lift table scissors	→ Remove object
Platform cannot be lifted up	Lift table is overloaded	→ Reduce load
	Hydraulic cylinder, foot pump or mechanics defective	→ Contact customer service

## Faults with Model HS 600 | AH

Fault	Possible Cause	Remedy
The lift table cannot be adjusted in height	Battery empty	→ Charge battery
	Push button unit or cable defective	→ Contact customer service
	Battery or component in box defective	→ Contact customer service
Battery cannot be charged	CTEK charger or cable defective	→ Contact customer service
	Battery defective	→ Contact customer service

## 12 Maintenance and Repair

Maintenance and repair work may only be carried out by competent, trained and instructed personnel. If necessary, further operating instructions and/or additional documents must be observed.

	<p><b>After maintenance or repair work on the lift table, always carry out a function test.</b></p> <ul style="list-style-type: none"> <li>• It is forbidden to reach under the lift table platform before it is secured with the safety catches (see ⇒ section 12.1).</li> <li>• Model HS 600   AH: <u>Turn off the main switch</u> before carrying out any maintenance or repair work. <b>WARNING!</b> There is an acute <u>risk of electric shock</u> when opening the battery box even if the main switch is turned off!</li> <li>• Wear safety shoes with steel-toed caps.</li> <li>• Wear suitable protective clothing.</li> </ul>
---	--

	<p><b>Repair work on electrical, hydraulic and mechanical components may only be carried out by authorised and trained personnel.</b></p>
---	---

	<p><b>Before any maintenance and repair work is carried out, chapter ⇒ 4 "Safety" must be read carefully and observed.</b></p>
---	--

### 12.1 Safety Catches for Securing

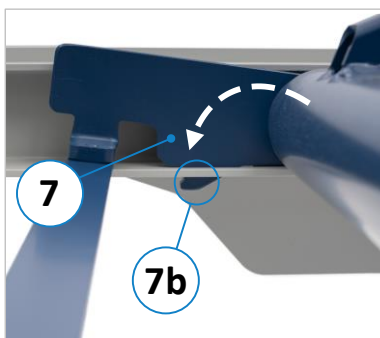

Figure 9: Safety catch for securing

The safety catches (7) on the longitudinal side are primarily used for securing during maintenance work that has to be carried out under the lift table platform. This mainly includes replacing the hydraulic cylinder. Since the lift table can no longer be held when the cylinder is removed, it can fall dangerously. For this reason, the safety catches must generally be used during maintenance work in the scissor area and underneath the platform.

To secure the lift table, move it upwards so that the safety catches (7) can be folded over. Now fold the safety catches (7) manually by 180° so that they engage in the catch point (7b) shown in ⇒ Figure 9.

#### 12.1.1 Replacing the Hydraulic Cylinder

Position the lift table so far upwards that the safety catches (7) can be folded down. Then fold down the two interconnected safety catches (⇒ Figure 9) and lower the lift table so that the safety catches are engaged. The hydraulic cylinder is now released and accessible for removal.

	<p><b>Stop! Do not work under the lift table platform until it is mechanically locked via the safety catch. <u>Non-compliance can result in life-threatening injuries.</u></b></p>
---	--

### 12.2 Maintenance Intervals

Interval	Action
Daily	Check all components for damage and have them replaced by competent personnel if necessary. If you have any questions, please contact our support (phone: 0049 7576 / 962 978 - 0).
Monthly	Lubricate the castors and bearings a little.
Annual	Make and document annual inspection of the lift table according to regulations.

## 13 Battery Charging Unit

The battery charger "MXS 5.0" integrated in the battery box is a commercially available, microprocessor-controlled charger from the manufacturer CTEK.

- ☞ The charging voltage for the lead gel battery installed in the HS 600 | AH is 14.4 volts.

### 13.1 CTEK MXS 5.0 - Operation Instructions

## HOW TO CHARGE

1. Connect the charger to the battery.
2. Connect the charger to the wall socket. The power lamp will indicate that the mains cable is connected to the wall socket. The error lamp will indicate if the battery clamps are incorrectly connected. The reverse polarity protection will ensure that the battery or charger will not be damaged.
3. Press the MODE-button to select charging program.
 



**SMALL BATTERY PROGRAM**



**NORMAL BATTERY PROGRAM**

Continue to press the MODE-button to combine charging program with charging options.

**AGM AGM OPTION**

**RECOND RECOND OPTION**

Press the MODE-button several times until the desired combination of charging program and options are lit.

- 4. Follow the 8-step display through the charging process.  
 The battery is ready to start the engine when STEP 4 is lit.  
 The battery is fully charged when STEP 7 is lit.
- 5. Stop charging at any time by disconnecting the mains cable from the wall socket.

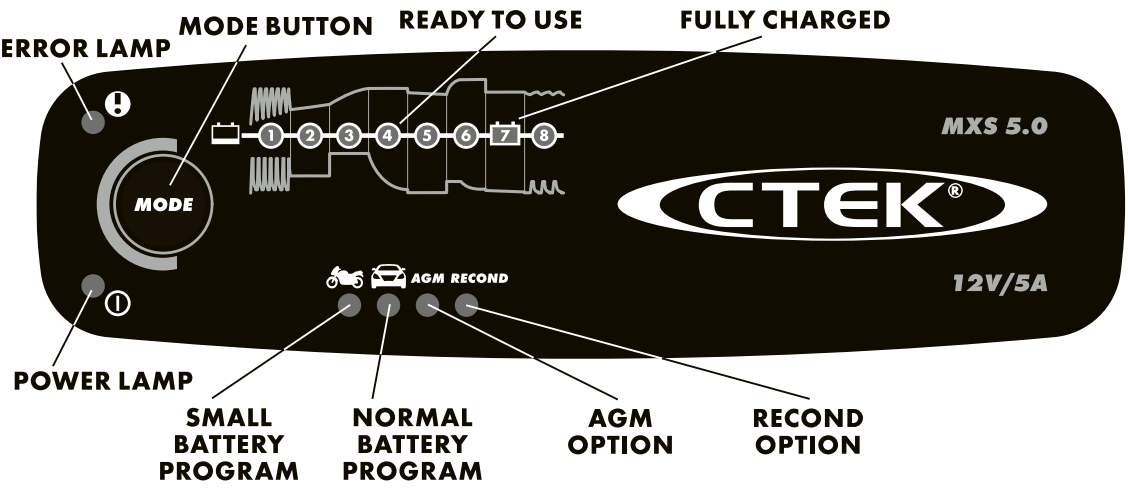

The diagram shows the CTEK MXS 5.0 12V/5A charger with the following components labeled:
 

- ERROR LAMP**: Indicated by a red exclamation mark icon.
- POWER LAMP**: Indicated by a power symbol icon.
- MODE BUTTON**: A circular button with the word "MODE" on it.
- 8-STEP DISPLAY**: A row of eight numbered LEDs (1-8) with a battery icon above them.
- SMALL BATTERY PROGRAM**: Indicated by a motorcycle icon.
- NORMAL BATTERY PROGRAM**: Indicated by a car icon.
- AGM OPTION**: Indicated by a motorcycle icon.
- RECOND OPTION**: Indicated by a car icon.
- READY TO USE**: Indicated by a battery icon.
- FULLY CHARGED**: Indicated by a battery icon.

→ Select charging mode “14,4 V / 5 A”





**CAUTION! Charging voltages higher than 14.4 V can damage or destroy the battery!**

## CHARGING PROGRAMS

Settings are made by pressing the MODE-button. After about two seconds the charger activates the selected program. The selected program will be restarted next time the charger is connected.

The table explains the different Charging Programs:

Program	Battery Size (Ah)	Explanation	Temp range
	1.2-14Ah	<b>Small battery program</b> 14.4V/0.8A Use for smaller batteries.	<b>-20 °C – +50 °C</b> (-4 °F – 122 °F)
	14-160Ah	<b>Normal battery program</b> 14.4V/5A Use for WET batteries, Ca/Ca, MF, GEL batteries and many AGM batteries.	<b>-20 °C – +50 °C</b> (-4 °F – 122 °F)
<b>AGM</b>	14-160Ah	<b>AGM option</b> 14.7V/5A Use for charging most AGM batteries like Optima and Odyssey.	<b>-20 °C – +50 °C</b> (-4 °F – 122 °F)
<b>RECOND</b>	14-160Ah	<b>Recond option</b> 15.8V/1.5A Use to return energy to the empty WET and Ca/Ca batteries. Recond your battery once per year and after deep discharge to maximise lifetime and capacity. The Recond program adds STEP 6 to the <b>normal battery program</b> .	<b>-20 °C – +50 °C</b> (-4 °F – 122 °F)



## ERROR LAMP

If the error lamp is lit, check the following:

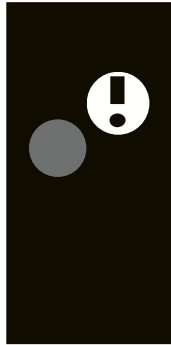

**1. Is the charger's positive lead connected to the battery's positive pole?**

**2. Is the charger connected to a 12V battery?**

**3. Has charging been interrupted in STEP 1, 2 or 5?**

Restart the charger by pressing the MODE-button. If charging is still being interrupted, the battery...

**STEP 1:** ...is seriously sulphated and may need to be replaced.

**STEP 2:** ...can not accept charge and may need to be replaced.

**STEP 5:** ...can not keep charge and may need to be replaced.

## POWER LAMP

If the power lamp is lit with a:

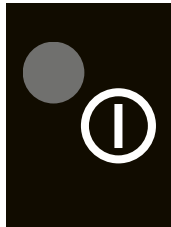

**1. STEADY LIGHT**

The mains cable is connected to the wall socket.

**2. FLASHING LIGHT**

The charger has entered the energy save mode. This happens if the charger isn't connected to a battery in 2 minutes.

## READY TO USE

The table shows the estimated time for empty battery to 80% charge.



BATTERY SIZE (Ah)	TIME TO 80% CHARGED
2Ah	2h
8Ah	8h
20Ah	4h
60Ah	12h
110Ah	26h

# CHARGING PROGRAM

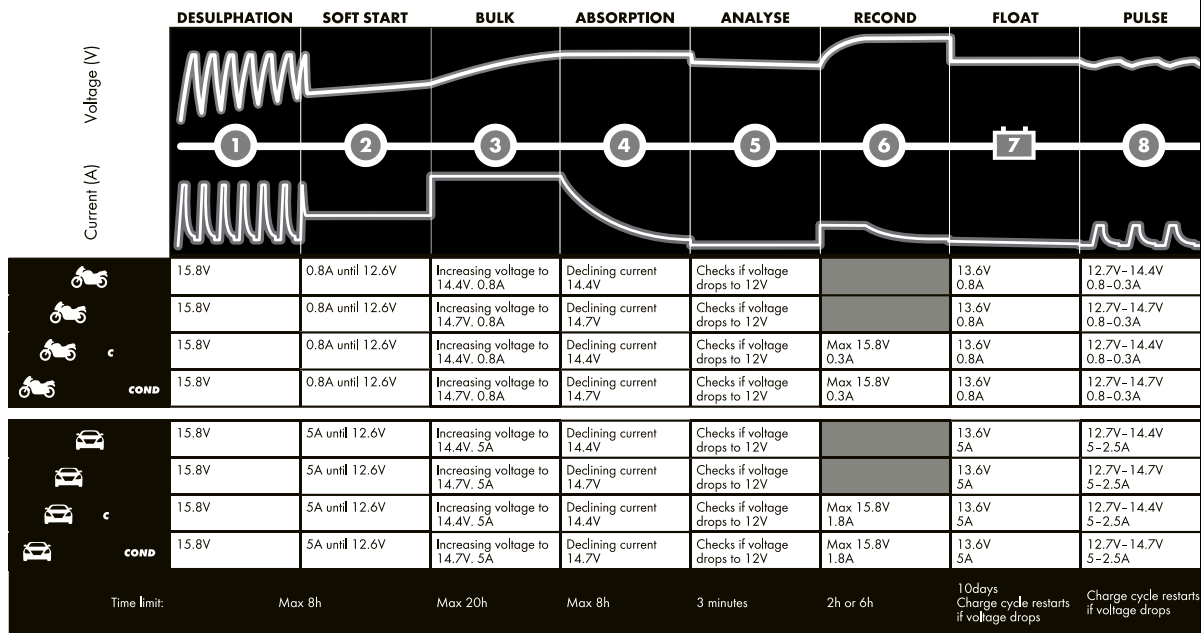

## STEP 1 DESULPHATION

Detects sulphated batteries. Pulsing current and voltage, removes sulphate from the lead plates of the battery restoring the battery capacity.

## STEP 2 SOFT START

Tests if the battery can accept charge. This step prevents that charging proceeds with a defect battery.

## STEP 3 BULK

Charging with maximum current until approximately 80% battery capacity.

## STEP 4 ABSORPTION

Charging with declining current to maximize up to 100% battery capacity.

## STEP 5 ANALYSE

Tests if the battery can hold charge. Batteries that can not hold charge may need to be replaced.

## STEP 6 RECOND

Choose the Recond program to add the Recond step to the charging process. During the Recond step voltage increases to create controlled gassing in the battery. Gassing mixes the battery acid and gives back energy to the battery.



## STEP 7 FLOAT

Maintaining the battery voltage at maximum level by providing a constant voltage charge.

## STEP 8 PULSE

Maintaining the battery at 95-100% capacity. The charger monitors the battery voltage and gives a pulse when necessary to keep the battery fully charged.

## TECHNICAL SPECIFICATIONS

<b>Model number</b>	1075
<b>Rated Voltage AC</b>	220-240VAC, 50-60Hz
<b>Charging voltage</b>	  14.4V, 14.7V, <b>RECOND</b> 15.8V
<b>Min battery voltage</b>	2.0V
<b>Charging current</b>	5A max
<b>Current, mains</b>	0.6A <sub>rms</sub> (at full charging current)
<b>Back current drain*</b>	<1Ah/month
<b>Ripple**</b>	<4%
<b>Ambient temperature</b>	-20°C to +50°C, output power is reduced automatically at high temperatures
<b>Charger type</b>	8 step, fully automatic charging cycle
<b>Battery types</b>	All types of 12V lead-acid batteries (WET, MF, Ca/Ca, AGM and GEL)
<b>Battery capacity</b>	1.2-110Ah up to 160Ah for maintenance
<b>Dimensions</b>	168 x 65 x 38mm (L x W x H)
<b>Insulation class</b>	IP65
<b>Weight</b>	0.6kg
<b>Temperature Compensation</b>	Built in charge voltage compensation according to ambient temperature.

\*) Back current drain is the current that drains the battery if the charger is not connected to the mains. CTEK chargers has a very low back current.

\*\*\*) The quality of the charging voltage and charging current is very important. A high current ripple heats up the battery which has an aging effect on the positive electrode. High voltage ripple could harm other equipment that is connected to the battery. CTEK battery chargers produce very clean voltage and current with low ripple.

## **SAFETY**

- The charger is designed for charging only for batteries according to the technical specification. Do not use the charger for any other purpose. Always follow battery manufacturers recommendations.
- Never try to charge non rechargeable batteries.
- Check the charger cables prior to use. Ensure that no cracks have occurred in the cables or in the bend protection. A charger with damaged cord must be returned to the retailer. A damaged mains cable must be replaced by a CTEK representative.
- Never charge a damaged battery.
- Never charge a frozen battery.
- Never place the charger on top of the battery when charging.
- Always provide for proper ventilation during charging.
- Avoid covering the charger.
- A battery being charged could emit explosive gasses. Prevent sparks close to the battery. When batteries are reaching the end of their lifecycle internal sparks may occur.
- All batteries fail sooner or later. A battery that fails during charging is normally taken care of by the chargers advanced control, but some rare errors in the battery could still exist. Don't leave any battery during charging unattended for a longer period of time.
- Ensure that the cabling does not jam or comes into contact with hot surfaces or sharp edges.
- Battery acid is corrosive. Rinse immediately with water if acid comes into contact with skin or eyes, seek immediate medical advice.
- Always check that the charger has switched to STEP 7 before leaving the charger unattended and connected for long periods. If the charger has not switched to STEP 7 within 50 hours, this is an indication of an error. Manually disconnect the charger.
- Batteries consume water during use and charging. For batteries where water can be added, the water level should be checked regularly. If the water level is low add distilled water.
- This appliance is not designed for use by young children or people who cannot read or understand the manual unless they are under the supervision of a responsible person to ensure that they can use the battery charger safely. Store and use the battery charger out of the reach of children, and ensure that children cannot play with the charger.
- Connection to the mains supply must be in accordance with the national regulations for electrical installations.

## 14 Decommissioning

- Before taking out of service, the platform of the lift table must be lowered completely.
- For recommissioning, observe chapter ⇒ 8 “Installation and commissioning”.
- For the final scrapping of the lift table, please refer to chapter ⇒ 15.

## 15 Disassembly and Scrapping

When dismantling and scrapping the lift table, the current EU regulations or the respective regulations and laws of the country of operation, which are prescribed for proper dismantling and disposal, must be observed. The aim is to dismantle the lift table and its various materials and components properly, to recycle all possible parts and to dispose of non-recyclable components in the most environmentally friendly way.

	<p><b>Please pay particular attention to</b></p> <ul style="list-style-type: none"> <li>• <i>the dismantling of the lift table in the working area</i></li> <li>• <i>proper dismantling of the lift table and accessories</i></li> <li>• <i>a safe and proper removal of the lift table</i></li> <li>• <i>proper separation of all components and materials.</i></li> </ul>
---	---

When dismantling and disposing the lift table, the laws and regulations in force at the place of use concerning health and environmental protection must be observed.

	<p><b>Remove all residues of oil, grease and other lubricants and have them disposed of properly by a qualified disposal company.</b></p>
--	---

When separating, disposing of or recycling the lift table materials, comply with the environmental protection laws in force at the place of use regarding the disposal of industrial solid waste toxic and hazardous waste.

	<ul style="list-style-type: none"> <li>• <i>Hoses and plastic parts as well as other components that are not made of metal must be dismantled and recycled or disposed of separately.</i></li> <li>• <i>Electrical components such as cables, switches, connectors, transformers, etc. must be removed and (if possible) recycled or otherwise disposed of in a qualified manner.</i></li> <li>• <i>Pneumatic and hydraulic parts such as valves, solenoid valves, pressure regulators, etc. must be removed and (if possible) recycled or otherwise disposed of in a qualified manner.</i></li> <li>• <i>Dismantle the base frame and all metal parts of the lift table and sort them according to material type. Metals can be melted down and recycled.</i></li> </ul>
---	---

In the event of improper disposal of lubricants, the following residual risks to the environment and health exist:

	<p><b>Pollution of the environment by seepage into groundwater or sewage system.</b></p>
---	--

	<p><b>Poisoning of the personnel contracted for the disposal.</b></p>
---	---

**Note:** The disposal of lubricants considered toxic and hazardous must be carried out in accordance with the regulations and laws in force at the respective place of use. Only qualified disposal companies that have the appropriate permits for the disposal of used oil and lubricants are to be commissioned with the disposal.

## 16 Options and Accessories

In the following tables you will find available options and accessories that you can use to upgrade your lift table. Please also visit our online shop <https://www.hokubema.com>.

	<p><b>Only use the original accessories and spare parts specified by the manufacturer. The use of other accessories or spare parts may cause injury to persons and damage to the lift table. The manufacturer accepts no liability for any damage resulting from the use of non-prescribed accessories and spare parts or additional components from third parties!</b></p>
---	---

### 16.1 Table Tops (Wood or Steel)

Article	Description	Art.-No.
<b>METAL SHEET TABLE TOP</b>	Made of smooth sheet steel, for HS 600, screwed onto platform. <i>Platform size = 1960 x 840 x 3 mm   Colour RAL 7035 (light-grey)   Weight approx. 42 kg</i>	200.205.00
<b>TABLE TOP BEECH-MULTIPLEX</b>	For HS 600, attachable to platform, plate is coated with linseed oil. <i>Platform size = 2000 x 1.000 x 30 mm   Weight approx. 45 kg</i>	200.200.00
<b>HOLE GRID TABLE TOP BEECH-MULTIPLEX</b>	For HS 600, attachable to platform, plate is coated with linseed oil. <i>Platform size = 2000 x 1.000 x 30 mm   Grid holes <math>\varnothing</math> 22 mm   Grid hole pitch T = 100 mm   Weight approx. 41 kg</i>	200.201.00
<b>TABLE TOP BIRCH-MULTIPLEX, BOTH SIDES HPL-COATED</b>	For HS 600, attachable to platform. <i>Platform size = 2000 x 1.000 x 30 mm   Colour RAL 9016 (traffic-white)   Weight approx. 46 kg</i>	200.210.00
<b>HOLE GRID TABLE TOP BIRCH-MULTIPLEX, BOTH SIDES HPL-COATED</b>	For HS 600, attachable to platform. <i>Platform size = 2000 x 1.000 x 30 mm   Grid holes <math>\varnothing</math> 22 mm   Grid hole pitch T = 100 mm   Colour RAL 9016 (traffic-white)   Weight approx. 42 kg</i>	200.217.00
<b>STEEL HOLE GRID PLATE</b>	For HS 600, screwed on, made of high-quality steel, mechanically machined with high precision. Surface: plasma-nitrided (corrosion-resistant + long-lasting wear protection), plate construction reinforced by cassette shaped welded-in web plates, for use during assembly work and as welding plate for filigree welding work. <i>Material thickness approx. ca. 11.5 - 13 mm   Bore radius 2 mm, Corners + edges R = 3/6 mm   Grid hole <math>\varnothing</math> 16 mm   Grid 50 x 50 mm</i>	
<b>16B-SYSTEM WITH 50 MM SIDE WALLS</b>	<i>Platform size = 2400 x 800 x 50 mm   Side wall H = 50 mm   Bore distance side wall = 50 mm   Weight approx. ca. 215 kg</i>	200.410.16
<b>16B-SYSTEM WITH 100 MM SIDE WALLS</b>	<i>Platform size = 2000 x 1000 x 100 mm   Side wall H = 100 mm   Bore distance side wall = 25 mm   Weight approx. 287 kg</i>	200.209.16
<b>TABLE TOP BEECH-MULTIPLEX WITH 3 DRAWERS</b>	Suitable for HS 600, with 2 drawer boxes, pull-out on both sides with spring bolt locking. <i>Platform size = 2000 x 1000 x 160 mm   Table top thickness = 27 mm   Internal drawer dimensions 900 x 560 x 100 mm   Weight approx. 74 kg</i>	200.203.00

Further information, illustrations and pre-configured HS 600 models can be found in our [catalogue](#).

## 16.2 Tilting Devices

Article	Description	Art.-No.
<b>TILTING DEVICE WITHOUT TABLE TOP</b>	Suitable for HS 600, tilting device hydraulically adjustable by hand, max. inclination 58°. <i>Platform size = 1900 x 740 x 160 mm   Weight approx. 45 kg</i>	200.206.00
<b>TILTING DEVICE WITH BEECH-MULTIPLEX HOLE GRID PLATE</b>	Plate screwed onto platform, plate is coated with linseed oil, tilting device hydraulically adjustable by hand, max. inclination 58°. <i>Panel size = 2000 x 1000 x 30 mm   Grid holes Ø 22 mm   Grid hole pitch T = 100 mm   Weight approx. 85 kg</i>	200.207.00
<b>TILTING DEVICE WITH METAL SHEET HOLE GRID PLATE</b>  Note: Accessories for the sheet metal hole grid plate see section ⇒ 16.7 Fehler! Verweisquelle konnte nicht gefunden werden.	Plate screwed onto platform, powder-coated, tilting device hydraulically adjustable by hand, max. inclination 58°, with continuous stop rail on the lower and left side. <i>Panel size = 2000 x 1000 x 3 mm   Grid holes Ø 22 mm   Grid hole pitch T = 50 mm   Colour RAL 7035 (light-grey)   Weight approx. 85 kg</i>	200.208.00

## 16.3 Further Options and Accessories

Article	Description	Art.-No.
<b>TOOL TRAY</b>	Practical tool and small parts tray, mounted below the table top on the opposite side of the foot pedal. <i>Inner size 1900 x 125 x 110 mm   Weight approx. 15 kg</i>	200.214.00
<b>ROTATING PLATFORM 360° WITH TABLE TOP BEECH-MULTIPLEX</b>	Suitable for HS 600, mounted on lift table. Rotating movement: Manual operation by spring-operated linkage with recessed grip. With turntable ball bearing, 90° grid system with 4 x stop. <i>Platform size = 2000 x 1000 x 30 mm   Construction height = 100 - 120 mm Weight approx. 100 kg</i>	200.215.00
<b>ENERGY BAR WITH CENTRAL CONNECTION FOR POWER AND COMPRESSED AIR</b>	Suitable for HS 600, 230 V supply cable, 3 m long. Connections: 3 earthed sockets with cover and 4 quick couplings for compressed air. <i>Weight approx. 2 kg</i>	200.407.00
<b>STEERING STOP</b>	1 piece steering stop for swivel castor. The direction stop turns the steering castor into a fixed castor. The steering direction is stabilised. <i>Weight approx. 1 kg</i>	200.001.00
<b>STATIONARY VERSION</b>	4 foot plates with threaded bolts, adjustable by ± 15 mm for floor levelling. <i>Weight approx. 6 kg</i>	200.020.00
<b>LOCKING DEVICE WITH 4 ADJUSTABLE FEET</b>	Suitable for HS 600, by turning the lever the lift table is lifted approx. 10 mm and brought from the mobile to a static rest position. With 4 adjustable feet and hand lever for optimum stability. <i>Weight approx. 30 kg</i>	200.300.00

## 16.4 Accessories for Model HS 600 | AH

Article	Description	Art.-No.
<b>RADIO CONTROL FOR BATTERY HYDRAULICS</b>	Wireless operation for up/down.	190.151.00
<b>PUSH BUTTON UNIT WITH SPIRAL CABLE</b>	Instead of normal cable, including emergency stop button. <i>Cable length = 2 m</i>	200.349.00

Further information, illustrations and pre-configured HS 600 models can be found in our [catalogue](#).

## 16.5 Extension Systems for Models without Vacuum

Article	Description	Art.-No.
<b>PLATFORM EXTENSION ON ONE SIDE, WITHOUT PANEL</b>	Platform extension (pull-out per side max. 820 mm), suitable for HS 600. Can be fixed in 80 mm steps with locking bolts. <i>Support surface / Side = 810 x 160 mm   Weight approx. 20 kg</i>	200.320.00
<b>PLATFORM EXTENSION LEFT + RIGHT, WITHOUT PANEL</b>	As above, but double-sided version. <i>Weight approx. 40 kg</i>	200.220.00
<b>PLATFORM EXTENSION ON ONE SIDE, WITH TABLE TOP BEECH-MULTIPLEX</b>	Platform extension (pull-out per side max. 820 mm), suitable for HS 600. Can be fixed in 80 mm steps with locking bolts. <i>Support surface / side = 1000 x 200 x 30 mm   Weight approx. 23 kg</i>	200.323.00
<b>PLATFORM EXTENSION LEFT + RIGHT, WITH TABLE TOP BEECH-MULTIPLEX</b>	As above, but double-sided version. <i>Weight approx. 46 kg</i>	200.223.00
<b>PLATFORM EXTENSION ON ONE SIDE, WITH TABLE TOP BIRCH-MULTIPLEX, HPL-COATED ON BOTH SIDES</b>	Platform extension (pull-out per side max. 820 mm), suitable for HS 600. Can be fixed in 80 mm steps with locking bolts. <i>Support surface / side = 1000 x 200 x 30 mm   Colour RAL 9016 (traffic-white)   Weight approx. 23 kg</i>	200.324.00
<b>PLATFORM EXTENSION LEFT + RIGHT, WITH TABLE TOP BIRCH-MULTIPLEX, HPL-COATED ON BOTH SIDES</b>	As above, but double-sided version. <i>Weight approx. 46 kg</i>	200.224.00
<b>PLATFORM EXTENSION ON ONE SIDE, WITH HOLE GRID TABLE TOP BEECH-MULTIPLEX</b>	Platform extension (pull-out per side max. 820 mm), suitable for HS 600. Can be fixed in 80 mm steps with locking bolts. <i>Support surface / side = 1000 x 200 x 30 mm   Holes <math>\phi = 22</math> mm   Grid hole pitch T = 100 mm   Weight approx. 23 kg</i>	200.325.00
<b>PLATFORM EXTENSION LEFT + RIGHT, WITH HOLE GRID TABLE TOP BEECH-MULTIPLEX</b>	As above, but double-sided version. <i>Weight approx. 46 kg</i>	200.225.00
<b>PLATFORM EXTENSION ON ONE SIDE, WITH HOLE GRID TABLE TOP BIRCH-MULTIPLEX, HPL-COATED ON BOTH SIDES</b>	Platform extension (pull-out per side max. 820 mm), suitable for HS 600. Can be fixed in 80 mm steps with locking bolts. <i>Support surface / side = 1000 x 200 x 30 mm   Holes <math>\phi = 22</math> mm   Grid hole pitch T = 100 mm   Colour RAL 9016 (traffic-white)   Weight approx. 23 kg</i>	200.327.00
<b>PLATFORM EXTENSION LEFT + RIGHT, WITH HOLE GRID TABLE TOP BIRCH-MULTIPLEX, HPL-COATED ON BOTH SIDES</b>	As above, but double-sided version. <i>Weight approx. 46 kg</i>	200.226.00
<b>PLATFORM EXTENSION ON ONE SIDE, WITH METAL SHEET TABLE TOP</b>	Platform extension (pull-out per side max. 820 mm), suitable for HS 600. Can be fixed in 80 mm steps with locking bolts. <i>Support surface / side = 840 x 200 x 3 mm   Colour RAL 7035 (light-grey)   Weight approx. 26 kg</i>	200.329.00
<b>PLATFORM EXTENSION LEFT + RIGHT, WITH METAL SHEET TABLE TOP</b>	As above, but double-sided version. <i>Weight approx. 53 kg</i>	200.227.00

Further information, illustrations and pre-configured HS 600 models can be found in our [catalogue](#).



## 16.6 Accessories for Wood Hole Grid Panels

Article	Description	Art.-No.
<b>HORIZONTAL CLAMP</b>	Clamping spigot with trapezoidal internal thread, threaded spindle and thrust piece with protective cap. <i>Threaded spindle 40 mm adjustable   Weight approx. 1 kg</i>	200.607.22
<b>VERTICAL RAIL CLAMP 30 x 8.5 mm, FIXED PROJECTION</b>	For vertical workpiece clamping. <i>Projection = 120 mm   Clamping height max. 200 mm   Swivelling by 360°   Weight approx. 1 kg</i>	200.603.22
<b>VERTICAL RAIL CLAMP 22 x 8.5 mm, FIXED PROJECTION</b>	For vertical workpiece clamping. <i>Projection = 100 mm   Clamping height max. 200 mm   Swivelling by 360°   Weight approx. 1 kg</i>	200.710.22
<b>VERTICAL RAIL CLAMP 22 x 8.5 mm, VARIABLE PROJECTION</b>	For precise positioning, individual tensioning during vertical workpiece clamping. <i>Projection: 30 - 150 mm   Clamping height max. 200 mm   Swivelling by 360°   Weight approx. 1 kg</i>	200.711.22
<b>VERTICAL RAIL CLAMP 22 x 8.5 mm, FIXED PROJECTION, LEVER HANDLE WITH LATCHING MECHANISM</b>	The lever handle with latching mechanism offers dosed, fast and vibration-proof tensioning during vertical workpiece clamping. <i>Projection = 100 mm   Clamping height max. 200 mm   Swivelling by 360°   Weight approx. 1 kg</i>	200.712.22
<b>VERTICAL RAIL CLAMP 22 x 8.5 mm, VARIABLE PROJECTION, LEVER HANDLE WITH LATCHING MECHANISM</b>	The lever handle with latching mechanism offers dosed, fast and vibration-proof tensioning during vertical workpiece clamping. <i>Projection = 100 mm   Clamping height max. 200 mm   Swivelling by 360°   Weight approx. 1 kg</i>	200.713.22
<b>ONE-HAND VERTICAL RAIL CLAMP, 11 X 5 MM</b>	For vertical workpiece clamping. <i>Projection = 70 mm   Clamping height max. 150 mm   Swivelling by 360°   Clamping force 60 kg   Weight approx. 1 kg</i>	200.714.22
<b>HORIZONTAL TOGGLE CLAMP</b>	With 1 grid bolt and safety plug for powerful and gentle clamping. <i>Span = 35 mm   Automatic adaptation = 13 mm   Clamping force 250 kg   Weight approx. 1 kg</i>	200.715.22
<b>VERTICAL QUICK CLAMP</b>	With 1 grid bolt and safety plug for powerful and gentle clamping. <i>Span = 60 mm   Automatic adaptation = 35 mm   Clamping force 250 kg   Weight approx. 1 kg</i>	200.716.22
<b>VICE WITH QUICK ADJUSTMENT</b>	With 2 grid bolts. <i>Jaw width = 100 mm   Span max. 100 mm   Weight approx. 4 kg</i>	200.609.22
<b>ROUND STOP PIN</b>	With milled contact surface as counterpart for fastening workpieces. The stop can also be used as direct resistance of the workpiece. <i>Spigot <math>\varnothing = 40 / 22</math> mm   Length = 40 mm</i>	200.602.22
<b>SINGLE THRUST BEARING WITH 1 GRID BOLT AND SAFETY MECHANISM</b>	As thrust bearing for the angular gear clamp, for clamping and fixing workpieces with grid bolts and safety mechanism. <i>Weight approx. 1 kg</i>	200.601.22

Continuation see ⇒ next page

Continuation “16.6 Accessories for Wood Grid Hole Panels“

Article	Description	Art.-No.
<b>ANGULAR GEAR TENSIONER WITH 2 GRID BOLTS</b>	Provides secure footing in the matrix plate and enables uniformly strong clamping. <i>Nutzhub = 130 mm   Pressure plate = 100 x 78 mm   Clamping force max. 500 kg   Total length = 260 mm   Weight approx. 4 kg</i>	200.608.22
<b>ANTI SLIP SUPPORT RAIL</b>	1 anti-slip support rail with 600 mm or 1200 mm length and 2 grid bolts. For all perforated grid plates with a hole diameter of 22 mm. For non-slip processing of objects without additional clamping. <i>Length = 600 oder 1200 mm   Weight approx. 2 resp. 3 kg</i>	600 mm long: 200.612.22 1200 mm long: 200.610.22
<b>CROSS EXTENSION RAIL WITH CARPET PAD<sup>3</sup></b>	1 cross extension rail with carpet support, can be fixed on the 30 mm thick table top for widening. <i>Length = 1300 mm   Extension widenable up to 1800 mm   Weight approx. 5 kg</i>	200.606.00
<b>BRUSH PLATE ELEMENTS<sup>3</sup></b>	Ideal support so that workpieces/panels rest gently and without scratches during machining. For screwing onto a wooden table top. <i>Format of the single plate = 499 x 99 mm   Bristle height = 15 mm   Bristle Ø = 0.4 mm   Load per m<sup>2</sup> approx. 20 kg   Weight approx. 8 kg   Packaging unit 1m<sup>2</sup></i>	200.500.00

## 16.7 Accessories for Metal Hole Grid Panel (Art.-No. 200.208.00)

Can only be used for 3 mm thick metal hole grid plates with Ø 22 mm!

Article	Description	Art.-No.
<b>ANGULAR GEAR TENSIONER WITH 2 GRID BOLTS</b>	Provides secure footing in the metal sheet hole grid plate (with pitch: 50 mm and thickness: 3 mm) and enables uniformly strong clamping. <i>Effective stroke = 130 mm   Pressure plate = 100 x 78 mm   Total length = 260 mm   Clamping force max. 500 kg   Weight approx. 4 kg</i>	200.704.22
<b>SINGLE THRUST BEARING WITH 1 GRID BOLT AND SAFETY MECHANISM</b>	As thrust bearing for the angular gear clamp on 3 mm metal sheet hole grid plates, for clamping and fixing workpieces with grid bolts and safety. <i>Weight approx. 1 kg</i>	200.701.22
<b>VERTICAL RAIL CLAMP 22 x 8.5 mm, FIXED PROJECTION</b>	For vertical workpiece clamping on 3 mm metal sheet hole grid plates. <i>Projection = 100 mm   Clamping height max. 200 mm   swivel by 360°   Weight approx. 1 kg</i>	200.703.22
<b>VERTICAL RAIL CLAMP 22 x 8.5 mm, VARIABLE PROJECTION</b>	For precise positioning, individual tensioning during vertical workpiece clamping 3 mm metal sheet hole grid plates. <i>Projection: 30 - 150 mm   Clamping height max. 200 mm   swivel by 360°   Weight approx. 1 kg</i>	200.705.22

Further information, illustrations and pre-configured HS 600 models can be found in our [catalogue](#).

<sup>3</sup> **Note:** Can also be used on the 30 mm table top “Beech-Multiplex” (Art.-No. 200.200.00) without hole matrix.

## 16.8 Accessories for Steel Hole Grid Plate (Art.-No. 200.400.16 & 200.209.16)

Can only be used for steel hole grid plate with  $\varnothing$  16 mm holes!

Article	Description	Art.-No.
<b>QUICK RELEASE BOLT SHORT, WITH TWIST LOCK</b>	Optimal connecting element with twist lock for the steel hole grid plate accessories with $\varnothing$ 16 mm. The extra-large balls protect the chamfer of the holes and reduce internal friction. With nitrided surface. <i>Length = 53 mm   Hole grid <math>\varnothing</math> 16 mm</i>	200.850.16
<b>QUICK RELEASE BOLT SHORT, ADJUSTABLE</b>	Optimal connecting element with twist lock for the steel hole grid plate accessories with $\varnothing$ 16 mm. The adjustable ring allows the span to be set individually. This means that laser templates or tools made by the customer can also be clamped in the hole grid. With nitrided surface. <i>Length = 78 mm   Span 12 - 24 mm</i>	200.851.16
<b>QUICK RELEASE BOLT LONG, ADJUSTABLE</b>	Optimal connecting element with twist lock for the steel hole grid plate accessories with $\varnothing$ 16 mm. The adjustable ring allows the span to be set individually. This means that laser templates or tools made by the customer can also be clamped in the hole grid. With nitrided surface. <i>Length = 78 mm   Span 12 - 24 mm</i>	200.852.16
<b>UNIVERSAL STOP 115L</b>	Flexible locking with quick-release bolt due to combination of slotted hole and system bore. With nitrided surface. <i>Length = 115 mm   Width = 30 mm   Material thickness = 12 mm   Setting range = 50 mm</i>	200.853.16
<b>STOP AND CLAMPING ANGLE 90L</b>	Flexible locking with quick-release bolt through combination of slotted hole and 3 system holes. With nitrided surface. <i>Length = 90 mm   Width = 30 mm   Height = 90 mm   Material thickness = 12 mm</i>	200.854.16
<b>STOP AND CLAMPING ANGLE 90X</b>	Flexible locking with quick-release bolt through combination of slotted hole and 1 system hole. With nitrided surface. <i>Length = 90 mm   Width = 30 mm   Height = 25 mm   Material thickness = 12 mm</i>	200.855.16
<b>STOP AND CLAMPING ANGLE 300G</b>	Combination of slotted hole and system holes for flexible locking with quick-action clamping bolts. Can be used in a variety of ways, e.g. as a table extension. Surface: nitrided. <i>Length = 150 mm   Width = 49 mm   Height = 300 mm   Material thickness = 12 mm</i>	200.856.16
<b>VERTICAL RAIL CLAMP 20 x 13 mm, VARIABLE PROJECTION</b>	For precise positioning, individual clamping when clamping workpieces vertically. With burnished surface. <i>Infinitely adjustable projection 35 - 125 mm   Clamping height max. 200 mm   swivel by 360°</i>	200.857.16
<b>ECCENTRIC STOP <math>\varnothing</math> 75 MM</b>	The eccentric stop enables space-saving fixing of panels by simple, step-less twisting. Fastening with quick release bolts. Can also be used as a support. With nitrided surface. <i>Material thickness = 12 mm   Diameter <math>\varnothing</math> = 75 mm</i>	200.858.16
<b>ACCESSORIES BASIC SET 1</b>	Basic accessories for your steel hole grid plate with $\varnothing$ 16 mm holes. The set contains the following parts: <ul style="list-style-type: none"> <li>• 12 x Quick-release bolts (Art.-No. 200.850.16)</li> <li>• 4 x Stop and clamping angle 90X (Art.-No. 200.855.16)</li> <li>• 2 x Stop and clamping angle 90L (Art.-No. 200.854.16)</li> <li>• 8 x Universal stops 115L (Art.-No. 200.853.16)</li> <li>• 4 x Vertical clamp (Art.-No. 200.857.16)</li> <li>• 1 x Eccentric stop (Art.-No. 200.858.16)</li> </ul> <i>Weight approx. 15 kg</i>	200.870.16

Further information, illustrations and pre-configured HS 600 models can be found in our [catalogue](#).

## EU - Declaration of Conformity

in accordance with the EU Machinery Directive 2006/42/EC Annex II A

The manufacturer,

Fa. Reinhold Beck  
Maschinenbau GmbH  
Im Grund 23  
DE-72505 Krauchenwies (Germany)  
Phone: 0049 - 7576 962 978 0  
Fax: 0049 - 7576 962 978 90

hereby declares that the manufactured machine

Model: **Lift Tables HS 600 | FH and HS 600 | AH**  
Type designation: Lift Table  
Serial number(s):  
Year of manufacture:

in the version provided complies with the EU Machinery Directive 2006/42/EC and the following further directives:

The following harmonised standards and instructions have been applied in manufacturing the machine:

- **EN ISO 12100:2010** Safety of machinery - General principles for design - Risk assessment and risk reduction
- **EN 1570-1:2011** Safety requirements for lifting tables

Name: Beck  
First name: Reinhold  
Position: Managing Director

Krauchenwies, 12.11.2021

-----  
Place and date



-----  
Signature