

TRANSLATION OF THE ORIGINAL VERSION

PANHANS

QUALITÄT SEIT 1918

CE

Operating Manual

Tilting Spindle Moulder / Table Milling Machine

PANHANS 245 | 10



Machine-Type: **245 | 10**

HOKUBEMA Maschinenbau GmbH

Graf-Stauffenberg-Kaserne, Binger Str. 28 | Halle 120

DE 72488 Sigmaringen | Tel. +49 07571 755-0

E-Mail: info@hokubema-panhans.de | Web: <https://hokubema-panhans.de>

Space for notes:

HOKUBEMA Maschinenbau GmbH

Graf-Stauffenberg-Kaserne
 Binger Straße 28 | Halle 120
 DE 72488 Sigmaringen
 Tel.: +49 (0)7571-755-0
 Fax: +49 (0)7571-755-222

<h2>Handover Certificate</h2>		
Machine type:		
Machine no.:		
Construction year:		
Customer address (location of the machine):		
Name:		
Street:		
Postcode/City:		
Phone:	Fax:	
E-mail:		
<p>Warranty: On the basis of our Terms and Conditions of Sale, Delivery and Payment of the respective current status, we assume a warranty of 12 months, calculated from the day of delivery, for material defects and defects of title in connection with the delivery for the above-mentioned machine.</p>		
<p>Warranty claims: Warranty claims on the part of HOKUBEMA Maschinenbau GmbH only exist if we have received the signed handover certificate and the machine has been properly commissioned. We therefore ask for immediate return.</p> <p>Important: Please read and follow the instructions in chapter ⇨ 1 "Liability and Warranty".</p>		
<p>Confirmation of the buyer:</p> <ul style="list-style-type: none"> ✓ The machine described above was purchased by me/us. ✓ Together with this handover certificate, I have received the operating manual valid for the machine (edition: _____). ✓ The operating instructions have been read and understood by me, as well as by all persons responsible for operating the specified machine. I will ensure that persons working on the machine at a later date are also instructed accordingly. 		
_____ Name and position	_____ Date	_____ Signature of the customer
Address of the dealer (company stamp):	<p>The machine, including the operating manual, was handed over to the buyer and installed according to the specifications in the operating manual.</p> <div style="display: flex; justify-content: space-around; margin-top: 20px;"> <div style="text-align: center;"> _____ Date </div> <div style="text-align: center;"> _____ Signature - Customer Service </div> </div>	

Space for notes:

HOKUBEMA Maschinenbau GmbH

 Graf-Stauffenberg-Kaserne
 Binger Straße 28 | Halle 120
 DE 72488 Sigmaringen
 Tel.: +49 (0)7571-755-0
 Fax: +49 (0)7571-755-222

<h2>Handover Certificate</h2>		
Machine type:		
Machine no.:		
Construction year:		
Customer address (location of the machine):		
Name:		
Street:		
Postcode/City:		
Phone:	Fax:	
E-mail:		
<p>Warranty:</p> <p>On the basis of our Terms and Conditions of Sale, Delivery and Payment of the respective current status, we assume a warranty of 12 months, calculated from the day of delivery, for material defects and defects of title in connection with the delivery for the above-mentioned machine.</p>		
<p>Warranty claims:</p> <p>Warranty claims on the part of HOKUBEMA Maschinenbau GmbH only exist if we have received the signed handover certificate and the machine has been properly commissioned. We therefore ask for immediate return.</p> <p>Important: Please read and follow the instructions in chapter ⇨ 1 "Liability and Warranty".</p>		
<p>Confirmation of the buyer:</p> <ul style="list-style-type: none"> ✓ The machine described above was purchased by me/us. ✓ Together with this handover certificate, I have received the operating manual valid for the machine (edition: _____). ✓ The operating instructions have been read and understood by me, as well as by all persons responsible for operating the specified machine. I will ensure that persons working on the machine at a later date are also instructed accordingly. 		
_____ Name and position	_____ Date	_____ Signature of the customer
Address of the dealer (company stamp):	<p>The machine, including the operating manual, was handed over to the buyer and installed according to the specifications in the operating manual.</p> <div style="display: flex; justify-content: space-around; margin-top: 20px;"> <div style="text-align: center;"> _____ Date </div> <div style="text-align: center;"> _____ Signature - Customer Service </div> </div>	

Table of Contents

1	Liability and Warranty	11
2	Introduction	12
2.1	Legal Notice	12
2.2	Illustrations	12
3	Symbols	12
3.1	General Symbols	12
3.2	Symbols in Safety Instructions	13
4	General	14
4.1	Intended Use.....	15
4.2	Target Group and Previous Experience.....	15
4.3	Requirements for the Operators	15
4.4	Accident Prevention.....	16
4.5	General Safety Regulations.....	16
4.6	Included Components.....	17
4.7	Optional Accessories.....	17
5	Safety	18
5.1	Basic Safety Instructions	18
5.2	Application Area and Intended Use	18
5.2.1	Modifications and Conversions to the Machine.....	18
5.2.2	Permissible Tool Dimensions	19
5.2.3	Residual Risks.....	19
5.2.4	Observe the Environmental Protection Regulations	20
5.2.5	Organisational Measures	20
5.2.6	Personnel Selection and Qualification - Basic Duties	21
5.3	Safety Instructions for Specific Phases of Operation	21
5.3.1	Before Working.....	21
5.3.2	Normal Operation	22
5.3.3	Special work within the Scope of Maintenance Work as well as Troubleshooting in the Workflow	23
5.3.4	After Work	23
5.4	Safe Working Practices	23
5.4.1	Operator Training.....	23
5.4.2	Stability	23
5.4.3	Setting up and Adjusting the Machine	23
5.4.4	Tool Handling	24
5.4.5	Tool Clamping	24
5.4.6	Setting the Milling Fence	24
5.4.7	Direction of Rotation.....	24
5.4.8	Speed Selection.....	24
5.4.9	Machine Operation and Selection / Adjustment of Protective Devices	24
5.4.10	Use of work devices with protective function.....	26
5.4.11	Noise Reduction	26
5.4.12	Standard Safety Equipment	26

5.4.13	Optional Safety Equipment	26
5.5	Hazardous Areas	27
6	Machine Data	28
6.1	Technical Specifications	28
6.2	Working Area	29
6.3	Emission Levels	29
6.3.1	Noise Information	29
6.3.2	Noise Emission Values	29
7	Dimensions	30
7.1	Front View	30
7.2	Top View 1	30
7.3	Top View 2	30
8	Installation and Connection	31
8.1	Check Delivery Conditions	31
8.2	Transport to the Installation Site	31
8.3	Installing the Machine	31
8.4	Temporary Storage	32
8.5	Lashing on a Transport Vehicle	32
8.6	Connecting the Extraction Unit	33
8.6.1	Air Speed	33
8.6.2	Existing negative pressure at 20 m/s	33
9	Electrical Connection	34
9.1	Back-up Fuses (on-site)	34
9.2	Machine Socket	34
10	Components and Control Elements	35
11	Commissioning	36
11.1	Switching ON and OFF	36
11.2	Rotational Direction Switch	36
11.3	Switching the Spindle ON and OFF	36
11.4	Emergency Stop Function	37
11.5	Service Door with Safety Switch	37
12	Speed Setting	38
12.1	Cutting Speed Chart	38
13	Tool Change	39
13.1	With Quick Clamping Device (Standard)	39
14	Position the Milling Spindle	40
14.1	Height Adjustment	40
14.2	Tilt Adjustment	40
14.3	Zero-Degree Lock	40
15	Milling Fences	41
15.1	Placing and Aligning the Milling Fence	41

15.2	Functions and Adjustment of the Milling Fences.....	42
15.2.1	Fence Type 215 (Standard)	42
15.2.2	Fence Type 216 (Option).....	43
15.3	Operating the Fences.....	43
15.3.1	Fence plate adjustment	43
15.3.2	Folding up the protective hood.....	43
15.3.3	Fit a grooved board or safety bar guides.....	43
15.3.4	Tool covers for high milling arbors.....	44
15.3.5	Lifting off and removing the fence	44
15.4	Swivel-Away Device Type 219 (Option)	44
15.4.1	Swivel away the Milling Fence	44
15.5	Handwheel Adjustment for Type 216 (Option).....	45
15.5.1	Handwheel Battery Change	45
15.6	Ring Fence TAPOA 1639.....	46
16	Protection and Pressure Devices.....	47
16.1	TYPE 1629 GAMMA V (Standard).....	47
16.2	TYPE 1624 CENTREX (Option)	47
17	Optional Components	48
17.1	Integral Fence System for Fence Type 216	48
17.1.1	Operation and Functions.....	48
17.2	Table Slide Plate.....	48
17.3	Safety bar guides for the Milling Fence	49
17.4	Swivel-Away Device for the Milling Fence	49
17.5	Turntable (360 degrees) for the Milling Fence	49
17.6	Extendable Frame Support	49
17.7	TM 100 - RFID based Machine Access Control System	50
17.8	Tenoning and Slotting Device Type 1376.....	51
17.8.1	Operation.....	51
17.8.2	Table for Angular Cuts.....	51
17.8.3	Adaptation to the Machine Table (only required for retrofitting).....	52
17.8.4	Supplementary Protective Cover 1641 (Option)	52
17.9	Kickback Guard Type 1648.....	52
17.10	Power Feeders	53
17.10.1	Rigid Console for Power Feeders	53
18	Troubleshooting	54
19	Maintenance and Inspection	55
19.1	Maintenance of the Milling Fence	55
19.2	Maintenance of the Tenoning and Slotting Device Type 1376 (Option).....	55
19.3	Maintenance Plan	56
19.4	Readjust the Motor Brake.....	57
19.4.1	Check the Adjustment.....	57
19.4.2	Replace Motor Brake	57
19.5	Change and Tighten the Drive Belt	58

19.5.1	Checking the Drive Belt Tension.....	58
20	Lubrication Instruction	59
20.1	Change Lubricator.....	59
20.2	Lubrication Plan	60
21	Options and Accessories.....	61
21.1	Technical Extensions	61
21.2	Table Systems	61
21.3	Milling Fences	62
21.4	Milling Spindles and Arbors	63
21.5	Tenoning and Slotting Device	63
21.6	Power Feeders and Consoles	63
21.7	Special Accessories	64
22	Disassembly and Scrapping	65
	EU - Declaration of Conformity	66

List of Figures

Figure 1:	Nameplate	28
Figure 2:	Working area	29
Figure 3:	Dimensions - Front view	30
Figure 4:	Dimensions - Top view 1	30
Figure 5:	Dimensions - Top view 2	30
Figure 6:	Transport pallet.....	31
Figure 7:	Lashing points (4 x).....	32
Figure 8:	Suction nozzles	33
Figure 9:	Terminal Box.....	34
Figure 10:	Machine Socket	34
Figure 11:	Components and Control Elements	35
Figure 12:	Main switch	36
Figure 13:	Control panel.....	36
Figure 14:	Unlock service door	37
Figure 15:	Lock service door	37
Figure 16:	Lever to release the V-belt	38
Figure 17:	Cutting Speed Chart	38
Figure 18:	Milling arbor with quick clamping device.....	39
Figure 19:	Marking for upper spacer ring.....	39
Figure 20:	Handwheels for height / tilt adjustment	40
Figure 21:	Locking bolts and detent holes.....	41
Figure 22:	Move centrally over milling spindle	41
Figure 23:	Align dovetail receptacle to locking pin	41
Figure 24:	Lock and engage	41
Figure 25:	Operating elements Fence Type 215.....	42
Figure 26:	Operating elements Fence Type 216.....	43
Figure 27:	Locking bolt of Type 301	43
Figure 28:	Hydraulic swivel-away device.....	44
Figure 29:	Digital handwheel.....	45
Figure 30:	Battery change	45
Figure 31:	Operation elements of the ring fence TAPOA 1639.....	46

Figure 32: TAPOA 1639 ring fence adjustment	46
Figure 33: Protection and pressure device 1629 GAMMA V	47
Figure 34: Protection and pressure device 1624 CENTREX	47
Figure 35: Integral fence plates (option)	48
Figure 36: Integral fence plates - operation and functions	48
Figure 37: Optional Table Slide	48
Figure 38: Safety bar guide set	49
Figure 39: Turntable with opening for clamping	49
Figure 40: Clamping lever for extendable frame support	49
Figure 41: TM 100 - Machine Access Control System	50
Figure 42: Tenoning guard 1376	51
Figure 43: Angle ranges (position of the screws)	51
Figure 44: Adapt tenoning device (drilling sketch)	52
Figure 45: Kickback guard type 1648	52
Figure 46: Power feeder type PV84	53
Figure 47: Power feeder type Variomatic 4N	53
Figure 48: Console rigid	53
Figure 49: Adjusting screw of the motor brake	57
Figure 50: Tightening drive belt	58
Figure 51: Checking the belt tension	58
Figure 52: Change lubricator	59
Figure 53: Activation with activation screw	59
Figure 54: Lubrication points on the machine	60
Figure 55: Central lubrication	60

Revisions:

Revision	Editor	Modification	Date
000	AG	Original manual translated	01.04.2022

1 Liability and Warranty

When purchasing a machine or additional component (hereinafter referred to as “machine”), the General Terms and Conditions of Sale and Delivery of HOKUBEMA Maschinenbau GmbH generally apply. These are provided to the purchaser or operator at the latest when the contract is concluded.



IMPORTANT NOTE: Liability and warranty claims shall only commence from the point in time at which the signed handover certificate (see ⇒ page 3 resp. 5) from the dealer and/or end customer for the delivered machine has been submitted to HOKUBEMA Maschinenbau GmbH in written form.

Liability and warranty claims for personal injury and property damage are generally excluded if they are due to one or more of the following causes:

- Commissioning of the machine without prior machine instruction by an authorised and adequately trained specialist who is familiar with the function and dangers of the machine.
- Electrical connection as well as repair and/or maintenance work on electrical components by personnel who do not have the appropriate qualifications.
- Connection and repair and/or maintenance work on hydraulic or pneumatic components by personnel who do not have the appropriate qualifications.
- Non-observance of the instructions in the operating manual, in particular the chapter “Safety”.
- Improper use or operation in an unauthorised area of application.
- Improper assembly, commissioning, operation and maintenance of the machine.
- Unauthorised conversions or modifications to the machine or additional components.
- Operating the machine without using all the protective equipment available for the operation.
- Inadequate monitoring and maintenance of the machine components and protective devices.
- Continuing to operate the machine when faults, damage or defects are present.
- Processing materials that do not correspond to the machine's area of application.
- Carrying out operations that are not permitted for the machine supplied.
- Use of tools that are not permitted for the machine supplied.
- Operating the machine outdoors or in damp, wet or potentially explosive environments.
- Operation of the machine outside permissible ambient temperatures or humidity.
- Grossly negligent behaviour when handling or operating the machine.
- Impact by foreign bodies, e.g. stones, metal parts, etc.
- Improperly carried out repairs.
- Catastrophic events due to force majeure.

2 Introduction

This operating manual applies to the PANHANS 245|10 tilting spindle moulder. The purpose of this document is to acquaint the user with the machine and enable him to use it to the full extent of its intended capabilities. Additionally it contains important information to operate the machine safely, properly and economically. Observance of the manual helps to avoid hazards, reduce repair costs and downtimes and increase the reliability and service life of the machine.

Furthermore, this operating manual serves to supplement instructions based on national regulations for accident prevention and environmental protection.

	<p><i>This operating manual must always be available at the place of use of the machine. It must be read and followed by every person who is assigned to work on the machine, e.g.</i></p> <ul style="list-style-type: none"> • <i>during operation, including set-up, troubleshooting in the work process, removal of production waste and maintenance,</i> • <i>during maintenance (servicing, inspection, repair)</i> • <i>and/or during transport.)</i>
---	---

Apart from the operating manual and the legally binding accident prevention provisions applicable in the country and place of use, the recognized technical regulations for safe and proper work must also be observed.

2.1 Legal Notice



All contents of these operating instructions are subject to the rights of use and copyright of Hokubema Maschinenbau GmbH. Any reproduction, modification, further use and publication in other electronic or printed media, as well as their online publication, requires the prior written consent of Hokubema Maschinenbau GmbH.

2.2 Illustrations

All photos, figures and graphics contained in this document are for illustration and better understanding only and may differ from the current state of the product.

3 Symbols

3.1 General Symbols

Symbol	Meaning
	Indicates passages within this operating manual that must be particularly observed in order to prevent malfunctions or damage to the machine.
	Refers to chapters, sections, or figures within this document.
	Refers to an external document or a third-party source.

3.2 Symbols in Safety Instructions

Symbol	Safety Instruction
	General danger symbol, which requires the highest attention! <i>Failure to observe may result in damage to the equipment, serious injury or even death.</i>
	Warning of possible danger from forklift traffic! <i>Non-observance may result in life-threatening injuries.</i>
	Warning indicates a possible hazard under suspended loads! <i>Non-observance may result in life-threatening injuries.</i>
	Warning indicates a possible fall hazard! <i>Non-observance of these instructions may result in serious injuries.</i>
	Warning indicates a possible cutting hazard! <i>Risk of personal injury and possibly additional damage to equipment.</i>
	Reference to the obligation to wear protective gloves! <i>Non-observance of these instructions may result in personal injury.</i>
	Reference to the obligation to wear hearing protection! <i>Non-observance of these instructions may result in personal injury.</i>
	Reference to the obligation to wear protective goggles! <i>Non-observance of these instructions may result in personal injury.</i>
	Reference to the obligation to wear a respiratory protection mask! <i>Non-observance of these instructions may cause breathing difficulties and lung damage.</i>
	Reference to the obligation to wear safety shoes! <i>Non-observance of these instructions may result in personal injury.</i>
	Possible dangerous crushing hazard in the area of stationary objects! <i>Risk of personal injury and possibly additional equipment damage.</i>
	Reference to a possible crushing hazard! <i>Non-observance increases the risk of injury to hands and fingers!</i>
	This symbol warns of the dangers of electric voltage! <i>Failure to observe may result in damage to the equipment, serious injury or even death.</i>
	Fire hazard! Do not smoke and do not ignite open fire.
	Access for unauthorized persons prohibited! <i>Risk of personal injury and possibly additional equipment damage.</i>
	This safety notice indicates a possible dangerous pull-in hazard! Wearing loose clothing, jewellery as well as long untied hair is prohibited! <i>Risk of personal injury and possibly additional damage to property.</i>

4 General

The PANHANS type 245 | 10 is a universal tilting spindle moulder with height and tilt adjustable milling arbor, two directions of rotation, quick tool change device, adjustable speed as well as separately adjustable total and partial fence.

- The milling spindle is driven by a three-phase motor.
- The four speeds (3000 / 4500 / 6000 / 9000 rpm) can be adjusted by flipping the pulley via the belt quick tensioning device.
- The milling spindle, which can be tilted in the range from -5° to $+45.5^{\circ}$, is mounted in a dust-tight manner. Special ball bearings and careful alignment of all moving parts give the machine smooth running.
- The milling arbor is designed for clockwise and anti-clockwise rotation and is secured against rotation. It has a quick-change tool device, which means that the milling spindle does not have to be locked.
- The height and tilt adjustment is carried out manually via the two handwheels on the front side.
- The standard version has a type 215 fence incl. multiplex fence plates. The total fence is adjusted via the built-in handwheel (separate measuring device, e.g. setting gauge or similar, required). The partial fence is adjusted by means of a vernier scale. The optional fence type 216 has an LCD display on the handwheel to indicate the total fence position.
- The finely planed cast iron machine table has the dimensions 1100 x 760 mm and is provided with a rigid frame support. Extendable frame supports as well as a turntable are optionally available.
- Also optionally available is a larger table top with the dimensions 1340 x 800 mm. This larger version is available with or without a matching turntable.
- For both table sizes, single-sided and double-sided table extensions are available as accessories.
- The control panel on the front of the machine contains an ON/OFF switch and a rotation direction switch for the spindle, a signal lamp for the operating mode "climb milling", indication of the currently set speed via signal lamp as well as an emergency stop push button.
- The machine is equipped with a mechanical motor brake which ensures safe braking of the spindle even in the event of a power failure.
- The star-delta start-up of the drive motor takes place automatically via contactor control.
- A machine socket (e.g. for connecting a feeding unit) is fitted in the rear right-hand side of the machine.
- The lockable main switch is mounted on the machine stand.
- CE-compliant and GS-tested design.

4.1 Intended Use

The PANHANS 245|10 tilting spindle moulder is used exclusively for machining materials for which the milling cutter used is suitable (e.g. wood, chipboard, veneer). The machines are not suitable for milling metal resp. plastic and waste wood which could contain nails, screws and other metal parts. The machine may only be operated on a firm, level surface with a minimum load-bearing capacity of 1,000 kg/m.



Improper use can lead to danger to persons and to a defect or damage to the machine.

4.2 Target Group and Previous Experience

This operating manual is intended for the operating and maintenance personnel of the machine. The operating personnel is to be determined by the operator and must further meet the following requirements:

- Basic technical knowledge (e.g. apprenticeship as carpenter, machine fitter, etc. and/or practice in operating tilting spindle moulders resp. woodworking machines)
- Reading and understanding these operating and maintenance instructions

In order to acquire the knowledge required to operate this machine, the operator must ensure the following measures:

- Product training for every operator (also possible external personnel)
- Regular safety instruction

4.3 Requirements for the Operators

- The tilting spindle moulder may only be operated by trained personnel who have also read this manual.
- Inspection, maintenance, cleaning and repair may only be performed by technical specialists with product-specific training and mechanical and/or electrical training.
- Specialists with product-specific training are to be commissioned and held responsible for planning and checking the work.
- The national protective regulations for employees must be observed.
- The operator is responsible for the safe use of the machine.
- The legal minimum age must be observed.

4.4 Accident Prevention

To avoid accidents, the following rules must be observed for operation:

- Prevent unauthorized persons from gaining access to the machine.
- Keep unauthorized persons away from the danger areas.
- Repeatedly inform present other persons about existing residual risks (refer to section ⇒ 5.2.3).
- Conduct and record regular training & instruction for persons who must be in the area of the machine.
- New employees must be trained internally to work on a thickener and this training must be documented.

4.5 General Safety Regulations

In general, the following safety regulations and obligations apply when handling the machine:

- A tilting spindle moulder may only be operated in a technically perfect and clean condition.
- It is prohibited to remove, modify or bypass any protective, safety or monitoring equipment.
- It is forbidden to modify or alter the machine without the written approval of the manufacturer / supplier.
- Faults or damage must be reported to the operator immediately, eliminated without delay and repaired if necessary.
- For repairs, only original spare parts may be used.
- All protective, safety and monitoring devices must be regularly checked and maintained by the operator.
- Only instructed, trained or qualified persons may work on this machine.
- Maintenance work must be carried out and documented in accordance with the maintenance instructions.
- After maintenance or repair, the machine may only be started with all protective devices fitted. A responsible person must be defined for this purpose, who checks that the guards have been properly installed.

For the operation of a tilting spindle moulder, the respective national safety regulations for employees as well as the national safety and accident prevention regulations apply.

4.6 Included Components

- Milling fence type 215 with manual total and partial adjustment and suction nozzle
- Milling protection and pressure device Type 1629 GAMMA V
- Dial gauges in the handwheels for height and tilt adjustment
- Second suction nozzle under the table Ø 120 mm
- Milling spindle Ø 30 mm with quick clamping nut
- Ring fence TAPOA Type 1639 for curved millings
- Cutter quick clamping device
- Finely planed cast iron table
- Hexagonal pin spanner SW4
- Hexagonal pin spanner SW5
- Push handle Type 2390
- Machine socket
- Grease gun

4.7 Optional Accessories

- Smooth-running, extendable frame support up to approx. 892 mm from the milling spindle centre
- Machine access control via RFID key system TM 100 with personalised keys
- Milling fence type 216 with LCD display for indicating the total fence
- Milling spindles Ø 35 mm / 40 mm / 50 mm / 1¼" (not retrofittable)
- Power feeder types "PV84" and "VARIOMATIC 4 N" and consoles
- Single and double-sided table top extensions with frame support
- Milling protection and pressure device type 1624 "CENTREX"
- Hydraulic swivel-away device for milling fence
- Tenoning and slotting device type "1376" and matching protective cover "1641"
- Integral fence plates for fence type 216
- Patented PANHANS table slide
- Kickback guard type "1648"
- Central lubrication
- Safety bar guides
- Turntable

Further optional table systems, milling fences, tool quick-change systems, milling spindles, tenoning and slotting devices, feed-units and other special accessories can be found in chapter ⇨ 21.

In addition, you can order accessories and spare parts in our online shop www.hokubema.com.

5 Safety

5.1 Basic Safety Instructions

Woodworking machines can be dangerous if used improperly. Therefore, observe the safety instructions listed in this chapter and the accident prevention regulations of your employer's liability insurance association!



The manufacturer accepts no liability for damage and malfunctions resulting from failure to observe these operating instructions.

5.2 Application Area and Intended Use



- ***The PANHANS tilting spindle moulder 245|10 is used exclusively for milling of solid wood (soft and hard woods) as well as plastics and wood-containing board materials.***
- ***This machine is not suitable for processing metal resp. plastic and scrap wood - which could contain nails, screws and other metal parts.***
- ***The machine may only be operated on a firm, level surface with a minimum load-bearing capacity of 1,000 kg/m².***

Any processing of other materials requires prior consultation with and approval of the manufacturer.



Improper use can lead to danger to persons and to a defect or damage to the machine.

Only workpieces that can be safely placed and guided may be machined.
Metallic materials must not be machined.

The machine is not suitable for operation outdoors or in potentially explosive areas.

- Permissible ambient temperature: +5 ... +40° C.
- Permissible humidity: 30 ... 90 %.

Number of workplaces: 1

The speed limits indicated on the tool must be strictly adhered to!



Only tools according to EN 847-1 are permitted that are marked with the BG-Test test mark or with the Hand Feed or MAN marks (cutting edge projection: max. 1.1 mm).

Intended use also includes the connection of the machine to an adequately dimensioned extraction system and compliance with the operating, maintenance and servicing conditions specified in the operating manual.

Any other use is not in accordance with the intended use and is therefore prohibited.

5.2.1 Modifications and Conversions to the Machine















Unauthorised conversions and modifications to the machine are strictly prohibited for safety reasons. This will invalidate the CE declaration of conformity! The manufacturer is not liable for any resulting damage. The risk for this is borne exclusively by the operator/user.









5.2.2 Permissible Tool Dimensions

Spindle Ø	Maximum clamping length	Milling cutters	Tenoning and slotting tools
30 mm	140 mm	80 - 250 mm	max. 300 mm
40 mm	160 mm	80 - 250 mm	max. 350 mm
50 mm	160 mm	80 - 250 mm	max. 350 mm
1¼"	140 mm	80 - 250 mm	max. 300 mm

5.2.3 Residual Risks

The machine is built according to the latest state of the art and the recognised safety rules. Nevertheless, the use of the machine may cause danger to life and limb of the user or third parties or damage to the machine and other equipment. Due to the construction of the machine, the following residual risks can occur even when used as intended and despite compliance with all relevant safety regulations:

	Reading and applying the operating manual is mandatory for the operating personnel.
	Be alert to possible crushing hazards: a) when transporting the machine by forklift truck → between forks & pallet / machine b) when picking up the machine → between machine / pallet and floor c) when lowering the machine → between machine and fixed equipment
	Be alert to possible crushing hazards when lowering the machine (from the cargo pallet to the floor) with a forklift truck or overhead crane.
	Make sure that no objects fall from the forklift truck / crane. Do not leave any objects / tools on the machine.
	It is strictly prohibited to ride on the machine during a lifting operation (with the indoor crane or forklift). There is a danger of falling!
	Unauthorised persons are not allowed to enter the installation area of the machine (responsibility of the operator).
	Be aware of possible tripping and slipping hazards on the floor. Prevent possible hazards by keeping the floor dry and clean and by using anti-slip floor coverings around the machine.
	Be aware of the danger from falling objects such as workpieces, tools or similar. Therefore, wear safety shoes, especially when transporting and setting down the machine.
	Pay attention to the existing danger of cuts on the cutter knives. Never reach into the running cutter! Use a power feeder or pushing device for short and narrow workpieces. Wear protective gloves when changing the milling cutter.
	Be aware of the danger of cutting through chips and splinters and never remove them from the danger area by hand and/or while the machine is running. Use suitable aids, e.g. hand brushes.
	Avoid climb milling. There is an increased risk of drawing in and kickback.
	Danger of being drawn in and increased risk of injury when wearing watches and jewellery. Wearing watches and jewellery is prohibited on the tilting spindle moulder.
	Be aware of a possible danger of being drawn in by moving machine parts or tools. This can cause pieces of clothing or hair to be caught. Always wear tight-fitting clothing or avoid loose clothing and wear a hair net if necessary.
	Danger from electric shock! There are hazards when working on the electrical system. This work must only be carried out by qualified personnel!
	Danger from electric shock! It is strictly forbidden to bypass safety devices (e.g. safety switches).

	Electrical equipment must be maintained and cleaned regularly.
	Pay attention to the danger of crushing on workpiece guides and moving machine parts.
	Make sure that no unauthorised persons are in the area of the machine.
	Be aware of the risk of injury from flying tool parts in the event of tool breakage. Therefore wear protective goggles.
	Be aware of the risk of injury from flying workpiece parts and chips, splinters and dust coming out of the machine. Therefore wear protective goggles.
	Be aware of the increased noise emission and wear hearing protection.
	Be aware of the increased dust generation. Use the extraction device and wear a dust mask if necessary.
	The emergency stop buttons must always be freely accessible. They must not be moved, e.g. with hopper boxes. Check the function of the emergency stop buttons daily (before starting work).
	Fire hazard due to wood dust in connection with flying sparks and/or open fire!

5.2.4 Observe the Environmental Protection Regulations

During all work with the machine, the environmental protection regulations, obligations and laws for waste avoidance and proper recycling and/or disposal applicable at the place of use must be observed. This applies in particular to installation, repair and maintenance work involving substances that could pollute the groundwater (e.g. hydraulic oils and cleaning agents and liquids containing solvents). In any case, prevent them from seeping into the ground or entering the sewage system.

	<p>Store and transport the above-mentioned hazardous substances only in suitable containers. Avoid leakage of hazardous substances by using suitable collection containers. Ensure that the above-mentioned substances are disposed of by a qualified disposal company.</p>
---	--

5.2.5 Organisational Measures



- ▲ Always keep this operating manual within easy reach and at the place of use of the machine.
- ▲ In addition to the operating manual, observe and instruct on generally applicable legal and other binding regulations for accident prevention and environmental protection.
- ▲ Supplement the operating manual with further instructions, including supervisory and reporting duties, to take account of special operational features (e.g. with regard to work organisation, work processes, personnel employed).
- ▲ Before starting work on the machine, the person responsible for its operation must have read the operating instructions, especially the chapter "Safety Instructions". This applies in particular to personnel who only occasionally work on the machine.
- ▲ Check that work is carried out in a safety-conscious and hazard-conscious manner and in compliance with the operating manual.
- ▲ Operators must not wear open long hair, loose clothing or jewellery (including rings). There is a risk of injury, e.g. by getting caught or drawn in.
- ▲ Observe the safety instructions and danger warnings on the machine and keep them complete and in legible condition.
- ▲ In case of safety-relevant changes to the machine or its operating behaviour, shut down the entire system immediately and report the fault to the responsible office/person.
- ▲ Use personal protective equipment as necessary or required by regulations.
- ▲ Do not make any modifications, additional attachments or conversions to the machine without the manufacturer's approval! This will compromise safety and invalidate the manufacturer's warranty and any liability claim.

- ⚠ Spare parts must meet the technical requirements specified by the manufacturer. The exclusive use of original spare parts ensures this. Therefore, only use original spare parts from the manufacturer.
- ⚠ Observe the fire alarm and firefighting possibilities. Make the location and operation of fire extinguishers (fire class ABC) known. Do not use water!

5.2.6 Personnel Selection and Qualification - Basic Duties

- ⚠ The machine design and operation is intended for right-handers.
- ⚠ Work on and with the machine may only be carried out by reliable personnel. Observe the legal minimum age!
- ⚠ Only use trained or instructed personnel. Clearly define the responsibilities of the personnel for operating, setting up, maintaining and repairing!
- ⚠ Ensure that only authorised personnel work on the machine!
- ⚠ If personnel to be trained or apprenticed have to work on the machine, this may only be done under the constant supervision of an experienced resp. qualified person.
- ⚠ Work on the electrical equipment of the machine may only be carried out by a qualified electrician or by untrained persons under the direction and supervision of a qualified electrician in accordance with the electrotechnical regulations.

5.3 Safety Instructions for Specific Phases of Operation

	<i>Defects and damage to the machine are to be reported immediately after detection.</i>
	<i>Any mode of operation that compromises safety is prohibited!</i>
	<i>Sufficient lighting around the machine must be ensured (at least 500 Lux)!</i>

5.3.1 Before Working

- ⚠ Clean the machine table from dirt and chips and provide containers for waste pieces.
- ⚠ Only use tools in perfect, sharpened condition and with clean clamping surfaces.
- ⚠ Always check workpieces to be machined for foreign objects, cracks and loose knots.
- ⚠ Only adjust the machine or fence when the machine is at a standstill.
- ⚠ Required aids such as tool cover, power feeder, table extensions, clamping drawer, feed devices (e.g. push block, push stick, bow spring, etc.) and use them as required.
- ⚠ Use a power feeder whenever possible.
- ⚠ Adjust the pressure devices and tool protection covers in the best possible way.
- ⚠ Adjust tools only when the tool is at a standstill using a dial gauge.
- ⚠ Before milling, remove any objects lying on the table (tools, spacers, etc.).
- ⚠ Observe the correct direction of rotation of the tool resp. avoid dangerous climb milling.
- ⚠ Use a continuous fence for safe workpiece guidance. If necessary, compensate for chip removal with the partial fence to ensure a continuous fence.
- ⚠ Keep the floor in the area of movement around the machine free of tripping hazards.
- ⚠ Ensure that the machine is connected to an extraction system.
- ⚠ Wear tight-fitting clothing and safety shoes and use safety glasses and ear protection.
- ⚠ If gloves are required for workpiece handling, they must be fingerless.

5.3.2 Normal Operation

- ▲ **Guards:** Take measures to ensure that the machine can only be operated in a safe and functional condition. Only operate the machine when all guards and safety-related devices such as

 - detachable guards (e.g. tool covers and fence covers),
 - emergency stop system, sound insulation, suction device etc.

are present and in working order.
- ▲ **Workpiece:** Before machining, inspect the workpiece for foreign inclusions, knots, twists, objects and other irregularities.
- ▲ **Working area:** An obstacle-free work area around the machine is essential for safe operation. The floor should be level, well maintained and free from debris such as chips and cut-off workpieces.
- ▲ **Rotation speed:** The speed must correspond to the milling cutter and the respective operation. The maximum speed indicated on the tool must not be exceeded. If a speed range is indicated on the milling cutter, this must be adhered to by not going above or below the speed range stated.
- ▲ **Cutting area during operation:** Never attempt to remove splinters, chips or other parts from the cutting area while the machine is running! Never remove splinters and chips by hand!

 - Cover the milling cutters before the fence by means of a protective device
 - Clamp milling cutters as deeply as possible
 - Adapt the table opening to the tool diameter with insert rings or optional Table Slide
 - Place the fence halves as close as possible to the milling tool and clamp them securely
 - Close the protective cover of the fence
- ▲ **Power feeder:** Generally adjust so that the workpiece is guided safely along the fence. Set the feeder at an angle of approx. 5° to the feed direction and keep the opening to the fence as small as possible.
- ▲ **Manual feeding:** When feeding the workpiece manually, place the hands flat on the workpiece with closed fingers and push forward evenly.
- ▲ **Special tools:** For certain operating phases and operations it is necessary to use special tools (e.g. feed device, table extensions, clamping drawer, push bar or comparable feed elements).
- ▲ **Single pieces / samples:** Always use all protective devices and appropriate tools!
- ▲ **Insert milling:** During insert milling, use optional table extensions with cross fences as well as a Kickback guard adapted to the workpiece dimensions.
- ▲ **Workpieces with small cross-section:** Always use one with a push block for machining.
- ▲ **Short workpieces:** For short workpieces, use a workpiece holder and bridge the fence halves.
- ▲ **Long workpieces:** When milling, generally use feather boards and table extensions and secure the workpiece against tipping.
- ▲ **Narrow grooves:** Always use a suitable grooving cutter (no circular saw blades).
- ▲ **Milling narrow cross sides:** Generally feed workpiece with push block.
- ▲ **Curved or round workpieces:** Use special suction bonnet when milling with a thrust ring or ring fence guard.
- ▲ **Extraction:** The machine must be connected to an effective extraction system. This requires a flow velocity of at least 20 m/s for dry chips and 28 m/s for moist chips (moist 18 % or more).
- ▲ **Machine condition:** Check the machine for externally visible damage and defects at least once per shift! Any changes that have occurred (including those in the operating behaviour) must be reported immediately to the responsible office or person! If necessary, stop and secure the machine immediately!
- ▲ **Work interruptions:** Switch off the machine even during short interruptions! Never leave the machine running unattended!

5.3.3 Special work within the Scope of Maintenance Work as well as Troubleshooting in the Workflow

- ⚠ Observe maintenance and inspection activities prescribed in the operating manual!
- ⚠ These activities, as well as all other repair work, may only be carried out by qualified personnel!
- ⚠ For all work concerning operation, production adjustment, conversion or setting of the machine and its safety-related equipment as well as maintenance and repair, observe switch-on and switch-off procedures according to the operating manual and instructions for maintenance work!
- ⚠ Secure the machine against unexpected restarting during maintenance and repair work.
→ **Lock the main switch with a padlock!**
- ⚠ Always tighten screw connections that have been loosened during maintenance and repair work!
- ⚠ If it is necessary to dismantle safety equipment during set-up, maintenance and repair, the safety equipment must be reassembled and checked immediately after completion of the maintenance and repair work!
- ⚠ Ensure safe and environmentally friendly disposal of operating and auxiliary materials (e.g. oils) and replacement parts (e.g. electronic components). See chapter ⇒ 22 "Disassembly and Scraping".

5.3.4 After Work

- ⚠ Before leaving the machine, switch off the main switch and the extraction system.
- ⚠ Secure the machine against unauthorised use and never leave it unattended in an unsecured condition.
- ⚠ Clean the machine with an industrial Hoover (avoid compressed air!).

5.4 Safe Working Practices

Depending on the work to be carried out, the guards must be used for fence milling, insert milling, curved milling and also for tenoning. Nevertheless, in order to prevent accidents, it is necessary that the user observes safe working practices.

5.4.1 Operator Training

It is important that all users of table milling machines are adequately instructed in the use, setting and operation. This concerns in detail:

- ⚠ Possible hazards that may occur when working with the machine.
- ⚠ The basics of machine operation, correct setting and use of the fences, templates, aids and guards.
- ⚠ The correct selection of the tool for the respective processing.
- ⚠ The safe workpiece guidance and feeding.
- ⚠ The correct hand position and safe stacking and unstacking of the workpieces before and after machining.

5.4.2 Stability

- ⚠ For safe operation of the machine, it is necessary that it is stable and securely fastened to the floor or another safe part of the building.

5.4.3 Setting up and Adjusting the Machine

- ⚠ Before starting the adjustment, the machine must be disconnected from the mains supply.
- ⚠ For tool clamping, refer to the recommendations of the tool manufacturer.
- ⚠ To ensure safe and effective machining, the tool must be suitable for the material to be machined.
- ⚠ Tools must be sharp and mounted on carefully balanced tool holders.

5.4.4 Tool Handling

- ⚠ Tools must be handled with care and tool transport equipment must be used whenever possible.

5.4.5 Tool Clamping

- ⚠ Use suitable devices, e.g. setting gauges, to clamp the tool when the machine is at a standstill.
- ⚠ To keep the gap between the spindle and the table as small as possible, the matching table insert rings must be used or the optional table slide plate (see ⇨ 17.2) must be set correctly.

5.4.6 Setting the Milling Fence

- ⚠ For milling straight workpieces, the milling fence must always be used to ensure adequate guidance of the workpiece.
- ⚠ Whenever the operation allows it (also for test cuts), an auxiliary fence must be used to keep the gap between the tool and the fence rulers as small as possible.
- ⚠ Whenever the working process allows it (also for test cuts), a power feeder must be used. This must be equipped with a separate ON and OFF switch.
- ⚠ For manual feed at the fence, a push stick must be used together with the safety guard to support the feed.
- ⚠ Roller stands or table extensions must be used as supports for long workpieces.

5.4.7 Direction of Rotation

- ⚠ It is important that the tool is clamped in the correct direction of rotation.
- ⚠ The safer machining method is conventional milling. The machine user must ensure that the workpiece is fed against the tool in the opposite direction to the spindle rotation.
- ⚠ Climb milling with manual feed involves considerable dangers. This operation is only permitted with appropriate devices and suitable tools. If the machine is switched to climb milling, this dangerous operation is signalled by a signal lamp on the control panel.

5.4.8 Speed Selection

- ⚠ The user must ensure that the correct speed is selected for the clamped tool.
- ⚠ For the optimum cutting speed, please refer to the diagram attached to the machine.

5.4.9 Machine Operation and Selection / Adjustment of Protective Devices



By using different milling spindles, tools and cutters, a large number of different machining operations can be carried out on the spindle moulder. Therefore, it is not possible to use only one protective device for all operations.

- Each operation should be considered separately. The most appropriate protective measures must be selected for each specific operation.
- The type of tool, its blade projection and its height on the spindle determine the smallest possible table opening.
- This can be achieved by selecting the appropriate table insert rings, which reduces the risk of the workpiece catching on the edge of the opening.
- The tool must be covered as far as the respective operation permits.
- A detachable power feeder attached to machine table combined with the milling fence can provide the most effective tool guarding. This combination is usually the best protective measure on table milling machines. The feeding device must be easily adaptable to the different workpiece dimensions and not cause any drawing-in hazards.

5.4.9.1 Milling at the fence, where the machining extends over the full workpiece length

With workpieces that usually have a right-angled cross-section over their entire length, this machining operation is carried out by using a milling fence. Since the fence rulers are at a 90° angle to the table top, the workpiece can be guided at right angles along the fence rulers.

Since the opening between the fence rulers on a table milling machine must be wide enough for the tool to pass through, unnecessary danger areas are created on the knives, on the tool body and on the spindle. The gap between the two fence rulers must be closed as much as possible. Otherwise there is a risk that the workpiece leading edge will catch on the edge of the take-off ruler. These hazards are avoided by the use of an auxiliary fence or suitable fence bridges, protective inserts, etc.

The manufacture of an auxiliary fence must be carried out with care. It is recommended that the knives are passed through by fine adjustment of the fence and not by pushing the fence into the tool by hand.

5.4.9.2 Insert Milling

Insert milling is milling at the fence, whereby the workpiece is not machined over its entire length. Instead of starting the cut at the beginning of the workpiece, the knives must plunge into the solid material and (depending on the requirement) plunge out again before reaching the end of the workpiece. The splinter tabs must be placed as close as possible to the cutter.

If the workpiece cannot be held safely by hand due to its small dimensions, a tenoning clamp or another workpiece holding device, together with a suitable guard (which secures the tool as far as possible) must be used. The tenoning clamp must allow fast and accurate insertion of the workpiece and ensure firm clamping.

A securely fastened front cross fence as well as a kickback guard (e.g. type 1648, see section ⇨ 17.9) must also be used. For very long workpieces, use an auxiliary fence if necessary.

Quick clamps, acting either via toggle levers or eccentrics, ensure fast and convenient workpiece clamping. Quick clamps, acting either via toggle levers or eccentrics, ensure fast and convenient workpiece clamping. Rear and/or front cross fences attached to the fence or on the table ensure more accurate work with the tenoning clamp. In addition, extension and retraction bars should be provided on the tenoning clamp.

5.4.9.3 Curved Milling

For shaping the workpiece to be machined, a clamping template must always be used for curve milling. The shape of the workpiece is achieved by pressing the template against the ring fence guard (see section ⇨ 15.6), while the knives are simultaneously passing by.

A clamping template cannot be used if the operation makes this impossible, e.g. if

- the workpiece is so large that the use of the template makes the work impracticable or
- the workpiece is so small or so shaped that a secure fixture in the template is not possible.

5.4.9.4 Inclined Milling

A special clamping device or inclinable stop rulers must be used to ensure a secure support during inclined milling. Push sticks must be used at the end of the milling process.

5.4.9.5 Climb Milling

Climb milling is a very dangerous operation as the operator is not able to stop the sudden forward movement of the workpiece when it is caught by the knives. In addition, the workpiece can be dangerously ejected. Climb milling should generally be avoided, even if a clamping device or a workpiece holding device is used. If the direction of rotation switch on the control panel is set turned to the "climb milling" position, this is signalled by an illuminated signal lamp next to the switch.

5.4.9.6 Other Work

If other work is carried out on the machine, suitable clamping devices or workpiece holding devices must be used to reduce the risk of accident.

5.4.10 Use of work devices with protective function

The following devices can be used to support the machine operator during work:

- clamping devices, push sticks and comparable aids
- detachable power feeders
- table extensions
- approach rails on workpiece guides

5.4.11 Noise Reduction

- The condition of the tools is important to reduce the noise level.
- The material and the requirement of the guards must be chosen in such a way that the noise level is reduced.
- The correct tool speed selection must be used to reduce the noise level.

	<p><i>If the workplace-related noise emission values of the machine exceed 85 dB(A), suitable hearing protection must be made available to the personnel!</i></p>
---	--

The use of personal hearing protection is not a substitute for the above options.

5.4.12 Standard Safety Equipment

- The main switch can be locked to protect the machine against unauthorised/unintentional switch-on during standstill as well as during repair and maintenance work.
- The machine is equipped with an emergency stop button on the front control panel.
- The cutter head is covered by means of the protection and pressure device GAMMA V 1629.
- The milling fence has a hinged protective cover to protect the tool from the top.
- With the insert rings included as standard, the table opening can be adapted to the tool diameter to keep it as small as possible.
- The service door at the front is equipped with a safety switch. This prevents the milling spindle motor from being switched on when the door is open.
- The TAPOA 1639 ring fence guard is used for accident-free milling of curved workpieces using a template. For tools up to \varnothing 160 mm, with thrust and protection ring, suction nozzle and transparent protective cover.

5.4.13 Optional Safety Equipment

5.4.13.1 Milling Protection and Pressure Device CENTREX 1624

(instead of the standard milling protection and pressure device GAMMA V 1629)

- Protection and pressure device for secure fixing of workpieces during manual milling operations
- The special shape of the pressure shoes ensures precise workpiece guidance for all milling operations.
- The fixture can be folded up and is attached to the milling fence.

5.4.13.2 Table Slide

(instead of the standard table insert rings)

- For quick, convenient and tool-free adjustment to different tools up to \varnothing 240 mm.
- Including front table insert with quick lock for tools up to \varnothing 155 mm.
- Available for both table sizes (1100 x 760 mm and 1340 x 800 mm).

5.4.13.3 Kickback Guard 1648

(for milling machines with optional table extension)





- For accident-free insertion milling of long and short parts (infinitely adjustable from 0 to 1500 mm).

5.4.13.4 Power Feeders

- For a safe workpiece feed (refer to section \Rightarrow 17.10).

You can find further accessories in chapter \Rightarrow 21 and in our online shop \Rightarrow <https://www.hokubema.com>

5.5 Hazardous Areas

Hazard	Area/Action	Risk	Avoidance
Cutting Hazard 	At the tool <ul style="list-style-type: none"> • When changing the cutter head • In case of contact with the rotating cutter 	Mild to severe injuries to hands and fingers	<ul style="list-style-type: none"> • Wear gloves when changing the cutter. • Keep hands out of the danger zone. • Use all available tool covers and fence bridges. • Do not push workpieces along the unsecured cutter by hand. • Use a power feeder or sliding block.
Risk of Kickback  Danger of being drawn in 	At the tool <ul style="list-style-type: none"> • When the splinter tabs are widely spaced apart! • Increased risk of Kickback when tilting the workpiece! • Increased risk of Kickback with incorrectly selected cutting or rotating speed! • Increased risk of Kickback when insert milling! • Increased risk of Kickback and draw-in during climb milling! • Increased risk of draw-in due to rotation of the cutter! 	Increased risk of injury or even death from ejected or flying workpieces, workpiece parts and tool parts (e.g. in the event of tool breakage). Increased risk of injuries or even death due to entrapment of hands, fingers, clothing, jewellery and long hair.	<ul style="list-style-type: none"> • Keep hands out of the danger zone. • Use all available tool covers and fence bridges. • Do not push workpieces along the unsecured cutter by hand. • Use a power feeder or sliding block. • Set splinter tabs correctly. • Use an anti-kickback device (also for test cuts!) and add a clamping device if necessary. • The values in the cutting speed table must be observed. • Never wear gloves while the milling spindle is running. • Wearing watches, jewellery and long hair are prohibited! • Wear tight-fitting clothes and hairnet if necessary.
Electric Shock Hazard 	On the electrical system and all current-carrying components.	Electric shocks with an increased risk of injury up to death	<ul style="list-style-type: none"> • Avoid wetness / moisture • Have defective parts, cables and insulation repaired immediately (only by qualified personnel!) • Do not touch energised components • Switch off and lock the main switch or disconnect the machine from the mains during any maintenance or repair work.

6 Machine Data

6.1 Technical Specifications

PANHANS 245/10	
Table Size:	760 x 1100 mm
Table Height:	870 mm
Milling Fence Type:	standard: 215 option: 216 (fence details see chapter ⇒ 15)
Ring Fence Type:	1639 Tapoa (details see section ⇒ 15.6)
Drive Motor:	5.5 kW (7.5 HP) option 7.5 kW (10 HP)
Motor Voltage:	400 VAC / 50 Hz
Motor Protection Class:	IP54
Motor Brake:	mechanical
Rotating Speed:	3000 / 4500 / 6000 / 9000 rpm
Milling Spindle:	Ø 30 mm (option 1 1/4", 35/40/50 mm)
Clamping Height:	140 mm
Height Adjustment:	125 mm
Spindle Tilt Range:	-5.0° ... +45.5°
Height & Tilt Adjustment:	manually by handwheel
Position Indicators (Height/Tilt):	analogue dial gauges in the handwheels
Suction Nozzles:	2 pieces, Ø 120 mm
Net Weight:	approx. 800 kg
Space Requirement:	2700 x 2770 mm

Nameplate:

PANHANS
HOKUBEMA by
HOKUBEMA GmbH • D-72488 Sigmaringen
Telefon/phone +49(0)7571 755-0

Tischfräsmaschine

Baureihe line	
Typ type	245 10
Maschinen-Nr. machine no.	
Baujahr year of construction	202_
Bemessungsspannung U = nominal voltage U =	V
Frequenz/Phasenzahl frequency/phases	Hz / 3
Stromart kind of current	AC
Volllaststrom I = operating current I =	A
Überstromschutz, intern excess current protection, internal	A

Figure 1: Nameplate

Manufacturer:

HOKUBEMA Maschinenbau GmbH
Graf-Stauffenberg-Kaserne
Binger Str. 28 | Halle 120
DE-72488 Sigmaringen (Germany)
Tel.: +49 (0) 7571 / 755-0
Fax: +49 (0) 7571 / 755-2 22

Expandability:

The machine is prepared for the later addition of special accessories (see chapter ⇒ 21) from the extensive manufacturer portfolio.

If you would like to retrofit your machine, please request documentation from us about the accessories you require.

Please indicate the following data:

1. **Type**
2. **Machine No.**
3. **Voltage (V)**
4. **Motor Power (kW)**
5. **Year of manufacture**

6.2 Working Area

The working area designates the position from which the machine is operated.

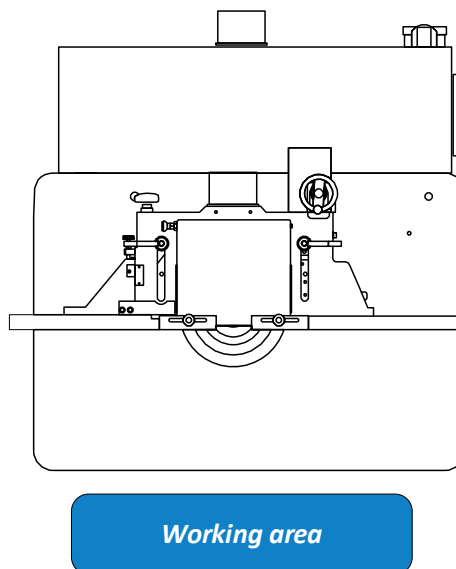

Figure 2: Working area

6.3 Emission Levels

6.3.1 Noise Information

The values given are emission levels and therefore do not necessarily represent safe workstation values at the same time. Although there is a correlation between emission and immission levels, it cannot be reliably deduced whether additional precautionary measures are necessary or not.

Factors that may affect the current immission level at the workstation include the duration of exposure, the nature of the workspace, other noise sources (e.g. the number of machines and other adjacent operations). The permissible workstation values can also vary from country to country.

However, this information should enable the user to make a better assessment of hazard and risk.

6.3.2 Noise Emission Values

The measurement values given are determined in accordance with the prEN 848-1 standard.

Uncertainty allowance $K = 4 \text{ dB(A)}$

Workplace-related emission value (acc. to EN ISO 11202)	
Idle	67.4 dB(A)
Operation	82.4 dB(A)

Noise level L_{WA} (acc. to EN ISO 3746)	
Idle	79.9 dB(A)
Operation	88.8 dB(A)



***The noise emission values of the machine partly exceed 85 dB(A)!
Therefore, suitable hearing protection must be provided to the personnel!***

Workplace-related dust emission value: The determined values comply with the required assessment values for the "GS wood dust test" mark by the German Woodworkers trade association (Holz BG).

7 Dimensions

7.1 Front View

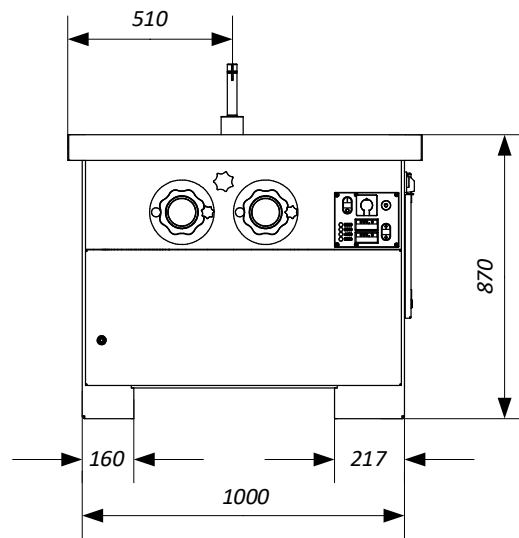

Figure 3: Dimensions - Front view

7.2 Top View 1

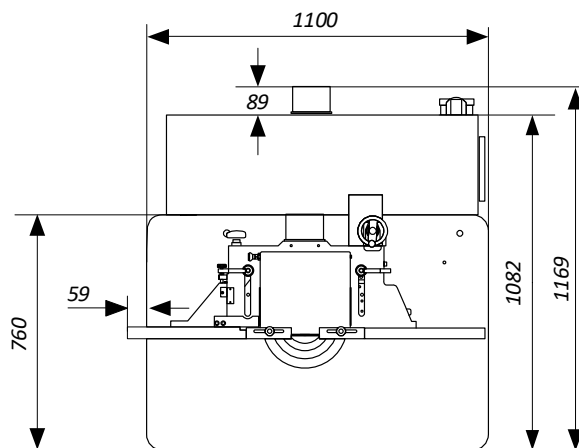

Figure 4: Dimensions - Top view 1

7.3 Top View 2

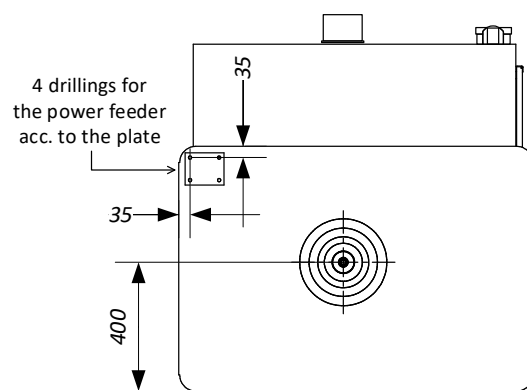

Figure 5: Dimensions - Top view 2

8 Installation and Connection

8.1 Check Delivery Conditions

Check the consignment for completeness and possible transport damage. In case of transport damage, please keep the packaging and inform the shipping company and the manufacturer immediately! Later complaints cannot be accepted.

8.2 Transport to the Installation Site

The machine is delivered on a transport pallet and is bolted to the bottom of the pallet.



	<p>Pay attention to the existing danger of tipping over during transport! The fork length of the forklift truck must be <u>at least 1.20 m!</u></p>
---	---



Figure 6: Transport pallet

The centre of gravity of the machine is approximately in the middle of the transport pallet.

- Move a pallet truck between the pallet timbers (see ⇨ Figure 6), lift the pallet only a few centimetres and move it to the immediate vicinity of the installation site.
- Remove the screw fastenings of the machine on the transport pallet.
- Move a forklift truck under the machine from the front and lift it a few centimetres.
- Lifting the machine off the pallet with the forklift truck.
- Move a lift truck from the front between the machine, lift it only a few centimetres, move it to the final installation location and place it there.



	<p>Be aware of possible crushing hazards when placing the machine (from the pallet to the floor) by means of a forklift truck or similar. Pay particular attention to your hands and feet and wear safety shoes and protective gloves as a precaution.</p>
---	---

	<p>Danger to life when using a forklift truck! Keep a sufficient distance from the forklift truck and watch its speed. Vehicles with combustion engines also produce toxic exhaust gases. Wear a breathing mask if necessary.</p>
---	--

8.3 Installing the Machine

A foundation is not required. The floor must have a load-bearing capacity corresponding to the weight of the machine (see section ⇨ 6.1).

- Unscrew the square timbers and place the machine on a horizontal workshop floor.
- The net weight of your machine can be found in ⇨ 6.1 (net weight means without accessories or options).
- Level out any unevenness of the floor with underlays and with the aid of a machine spirit level.
- There is a \varnothing 14 mm hole on each of the 4 feet of the machine. The machine can be screwed to the floor via these holes.
- Remove the existing lashing points (eyebolts) for truck transport and close the open internal threads with the enclosed blind plugs.
- The bare parts of the machine are greased to protect them from corrosion.
- Carefully degrease these parts protected against rust with petroleum or benzene.
- Activate lubricant dispensing by screwing in the activation screw until the ring eyelet breaks off (procedure see section ⇨ 20.1).

	<p>Fire hazard! Do not smoke and do not light an open fire.</p>
	<p>Do not use nitro thinner for cleaning. Painted surfaces of the machine can be damaged.</p>
	<p>Dispose of the packaging material in an environmentally friendly way!</p>

8.4 Temporary Storage

If the machine is not put into operation immediately after delivery, it must be stored carefully in a protected place. Carefully cover the entire machine so that neither dust nor moisture can penetrate.

The bare, non-surface-treated parts (e.g. the cast iron tabletop) are provided with a preservative. This must be checked regularly for effectiveness and renewed if necessary.

8.5 Lashing on a Transport Vehicle



Figure 7: Lashing points (4 x)

For transporting the palletised machine on a transport vehicle, a lashing point (Z) is attached to each of the four sides of the machine.



A separate lashing strap must be used for each lashing point (Z). All 4 lashing straps must be individually tensioned on the loading area!

The responsibility for safe loading is borne by the respective shipper!



The machine may only be lashed at the four lashing points (Z) provided!

Please note the following when lashing in the transport vehicle:

- The loading area of the transport vehicle must always be clean and dry.
- The lashing straps used must be suitable for the total weight of the machine (see section ⇒ 6.1).
- Fastening on the loading area is done by lashing down: This means that the transport pallet is secured by frictional locking. The load is pressed so firmly onto the loading surface that it can no longer slip. The clamping tool should have a high STF value at the frictional connection, e.g. long-lever ratchets.
- In addition, anti-slip mats should be used to provide even more safety.
- The ideal lashing angle (α) for tie-down lashing is 83° to and 90°. Therefore, the lashing straps should pull downwards approx. vertically. As the angle decreases, the pretensioning force of the lashing is reduced.
- Observe the permissible total weight of the transport vehicle.
- Ensure that the permissible axle loads of the transport vehicle are observed. The load must be distributed evenly on all axles of the vehicle.

8.6 Connecting the Extraction Unit

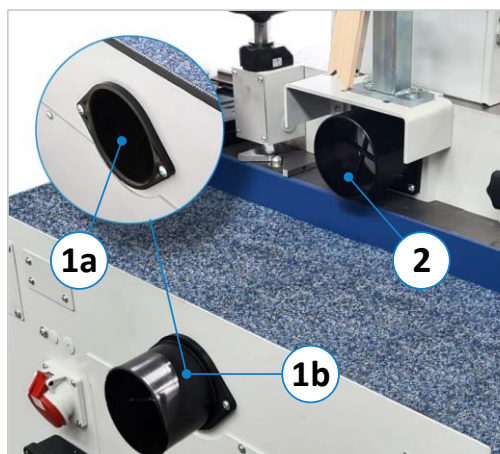

The machine must be connected to an effective extraction system on-site. The two extraction nozzles (1) and (2) each have an outer diameter of 120 mm.

For transport reasons, the lower extraction socket in the stand is mounted with the connection facing inwards (1a). Before connecting the extraction unit, it must first be unscrewed, turned to the outside and then mounted again (1b).



When the machine is switched on, the extraction system must start automatically.



When flexible suction hoses are used, they must be flame-retardant.

Figure 8: Suction nozzles

Two signal generator lines must be connected for automatic switching of the extraction system:

Version	Connection terminals
245/10	63 + 64 on contactor Q3

Please note: The connection terminals for the extraction system shown on the left apply to the standard machine. Depending on the equipment or with older models, these may differ. The valid terminals for your machine can be found in the circuit diagram (see ⇒ control cabinet).

Installation only by a qualified electrician!

All parts of the extraction system, including hoses, must be included in the earthing measure.

8.6.1 Air Speed

The air speed must be set in such a way that, with the extraction line connected and the tools stationary, an average air speed of

- 20 m/s (1450 m³/h) with dry chips,
- 28 m/s (2050 m³/h) with moist chips (moisture 18 % or more)

is achieved at the extraction nozzles.

8.6.2 Existing negative pressure at 20 m/s

- on the milling fence: 640 Pa
- under the table top: 300 Pa



- **The air velocity must be checked before initial commissioning and after significant changes.**
- **The extraction system must be checked daily for obvious defects after initial commissioning and monthly for effectiveness.**

9 Electrical Connection



The electrical connection must be carried out by an authorised electrician!

The electrical circuit diagrams are located in the control cabinet.

Please observe the specified nominal voltage 400 VAC / 50 Hz (3 phases / N / PE)!



The connection to the mains (3 phases) is made via the terminal strip in the terminal box on the right side of the machine.

- The 3 phases are to be connected to the terminals “L1”, “L2”, and “L3”.
- The protective earth wire (yellow/green) must be connected to the terminal marked “PE”, the neutral wire to the terminal marked “N” (please note: “N” is loaded!).
- Close the cable gland again so that it is dust-tight.



Observe the rotational direction of the milling cutter!

Figure 9: Terminal Box



If the cutter direction is wrong, two outer conductors must be interchanged.

9.1 Back-up Fuses (on-site)

Motor	5.5 kW	7.5 kW
400 V	25 A slow	32 A or 35 A slow

The regulations of the local electric power company apply!



The fault loop impedance and the suitability of the overcurrent protection device must be checked at the installation site of the machine.

Supply cable: Cu, 5-core. The cross-section must be determined on site by a qualified electrician!

9.2 Machine Socket

The machine socket integrated in the machine is located on the right side above the terminal box. It is internally fused with a back-up fuse of 6 - 10 A.



Please note: The machine socket only supplies power when the full engine speed has been reached.



Figure 10: Machine Socket

10 Components and Control Elements

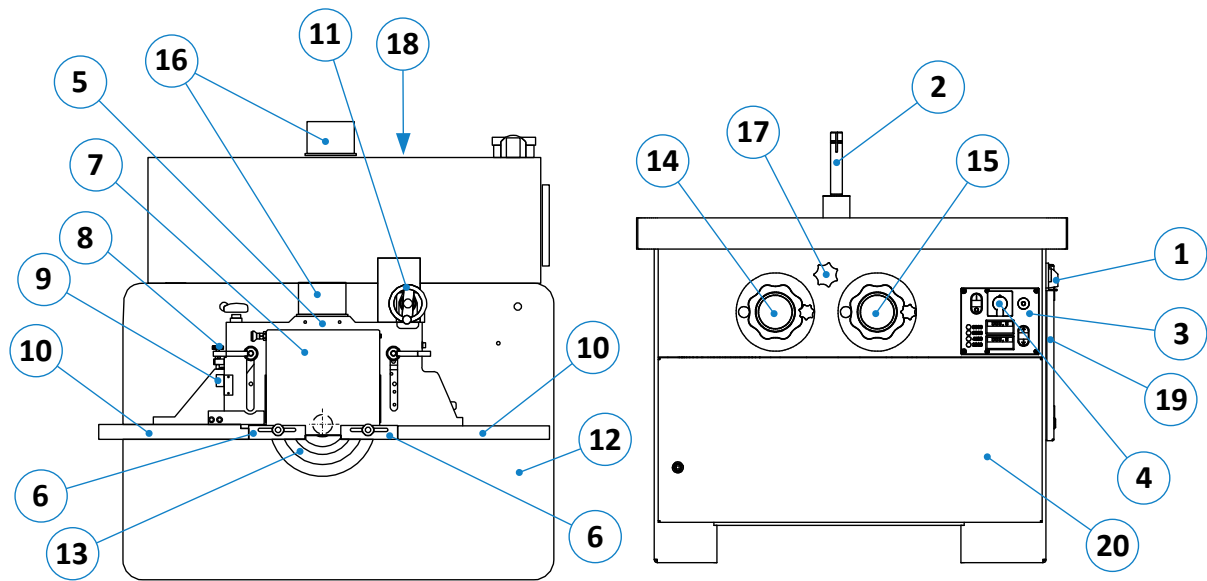



Figure 11: Components and Control Elements

Pos.	Description	Pos.	Description
1	Main switch	11	Manual adjustment for total fence
2	Milling spindle	12	Table top
3	Control panel	13	Table insert rings (table slide plate optionally)
4	Emergency stop	14	Tilt adjustment handwheel with dial gauge
5	Milling fence type 215	15	Height adjustment handwheel with dial gauge
6	Milling splinter tab (2 x)	16	Suction nozzle \varnothing 120 mm
7	Milling fence protective bonnet	17	0° locking
8	Adjusting screw partial fence	18	Position of terminal box and machine socket
9	Vernier scale partial fence	19	Control cabinet door
10	Fence plate (2 x)	20	Service door

11 Commissioning

Before commissioning, carefully read and observe this manual and the safety instructions in chapter ⇒ 5!

	<p>Before switching on, make sure that</p> <ul style="list-style-type: none"> • the cutter is firmly and securely clamped, • the machine table and fence are clean and free of objects, • the guards are fitted in accordance with regulations, • the extraction system is connected and in good working order • and the direction of rotation is selected to suit the tool and work process.
---	---

11.1 Switching ON and OFF

The machine is switched on and off via the main switch (1) on the right-hand side of the machine:

Switching ON → Turn the main switch to position “I”

Switching OFF → Turn the main switch to position “O”

	<p>If the milling spindle is started without a cutter, all the milling arbor rings and the clamping screw must be fitted and tightened.</p>
---	--



Figure 12: Main switch

After switching on the main switch (1), the speed set according to the V-belt position is indicated via the respective signal lamp (D), see ⇒ Figure 13. The speed setting is made according to chapter ⇒ 12.

11.2 Rotational Direction Switch

The spindle direction of rotation is specified via the turn switch (R) on the control panel:

Conventional milling → Turn switch (R) to the left (anticlockwise rotation, switchover only at standstill).

Climb milling → Press in switch (R) and turn to the right (clockwise rotation, switchover only at standstill).

	<p>Avoid climb milling, as this considerably increases the risk of accidents!</p>
---	--

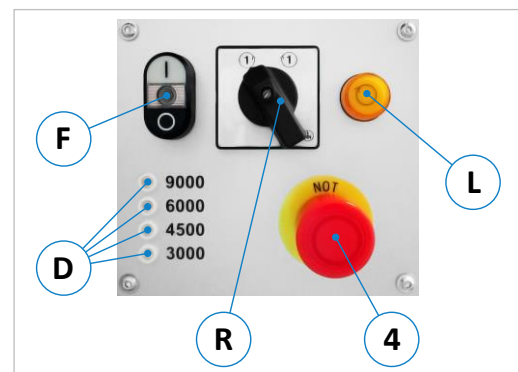



Figure 13: Control panel

11.3 Switching the Spindle ON and OFF

- To start the spindle, the main switch (1) must be turned on (position “I”).
- Set the desired speed according to chapter ⇒ 12.
- **Switching ON:** Press “I” on the switch (F)
→ The milling cutter is set in rotation with the preselected speed and direction of rotation.

	<p>Do not start working until the machine has reached full speed (after approx. 10 s).</p>
---	---

- **Switching OFF:** Press “O” on the switch (F)
→ The milling cutter is switched off and brought to standstill (braking time < 10 s).

11.4 Emergency Stop Function

In case of danger or malfunctions during operation, the machine can be stopped quickly and reliably by pressing the emergency stop button (4) on the control panel (see ⇒ Figure 13).

Before restarting the machine, the emergency stop button must be unlocked again.

	<p><i>The braking time of the motor to a standstill can be up to 10 seconds.</i></p>
---	---

11.5 Service Door with Safety Switch

The front service door of the machine is opened for various maintenance activities (for example, to adjust the speed, tighten or replace the drive belt or lubricate the machine). To prevent unintentional opening of the door during operation and the associated dangers, the maintenance door is equipped with a safety switch.

	<p><i>The front service door can only be opened if the safety switch has been unlocked with the knurled screw (R). To restart the machine, the safety switch must be locked beforehand.</i></p>
---	--

Unlocking:

To open the service door, the knurled screw (R) of the safety switch must be turned fully clockwise ⤵ as far as it will go.

→ The door is unlocked and can be opened.

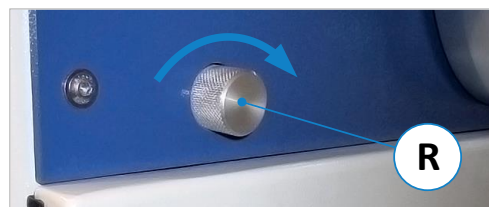

Figure 14: Unlock service door

Locking:

After completing the maintenance work, the service door must be closed and locked again. To do this, turn the knurled screw (R) of the safety switch fully counterclockwise ⤴ as far as it will go.

→ Only then can the machine be started again.

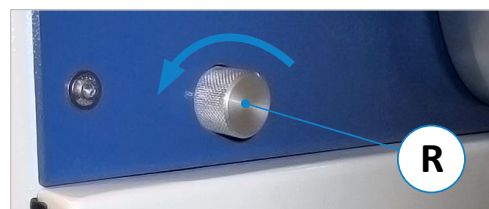

Figure 15: Lock service door

12 Speed Setting

With the 245|10 tilting spindle moulder, the speed is adjusted by shifting the V-belt.



Switch off the machine during speed adjustment and secure it against unexpected restarting. Lock the main switch with a padlock!

After switching off and locking the main switch, open the front service door and proceed as follows:

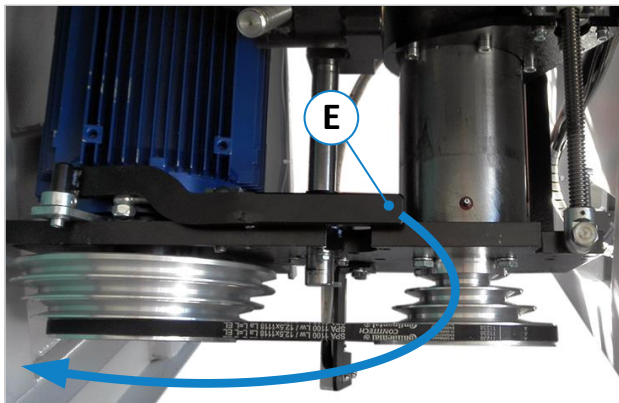
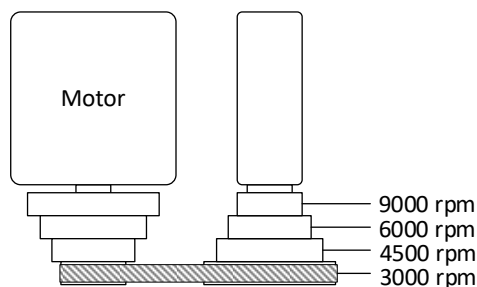

Figure 16: Lever to release the V-belt

- Swivel lever (E) according to ⇒ Figure 16.
- Set the loosened belt to the desired speed:



- To tighten, swing lever (E) back again.

- After the adjustment, set the brake release switch back to the right-hand position (normal operation).

Please also read the chapter ⇒ 19.5 “Change and Tighten the Drive Belt”.

12.1 Cutting Speed Chart

Tool diameter (mm)	Milling arbor speed (min ⁻¹)											
	2500	2800	3000	3500	4000	4500	5000	5500	6000	6500	7000	7500
450	59	66	71	82								
420	55	62	66	77								
400	52	59	63	73	84							
380	50	56	60	70	80							
350	46	51	55	64	73	82						
320	42	47	50	59	67	75	84					
300	39	44	47	55	63	71	79					
280	37	41	44	51	59	66	73	82				
250		37	39	46	52	59	65	73	79	85		
220			35	40	46	52	58	65	70	75	81	
200				37	42	47	52	59	63	68	73	79
180					37	42	47	53	57	61	66	71
160						38	42	47	50	54	59	63
140							37	41	44	48	51	55
120								35	38	41	44	47
100									34	37	39	42
80											33	38
60												31

Figure 17: Cutting Speed Chart

There is a cutting speed chart on the right-hand side of the machine.

- Select the speed for the cutter used according to the chart and be sure to avoid settings within the danger zones marked in yellow and red.



Increased risk of kickback, breakage and/or noise pollution when choosing a non-recommended setting!

13 Tool Change

13.1 With Quick Clamping Device (Standard)

 **The tools used on the machine must comply with EN 847-1!**

 **Wear cut-resistant protective gloves when changing tools!**

- With the spindle running, first press “○” on the switch (F) to switch of the spindle (see ⇒ Figure 13). Then wait approx. 15 → The motor brake opens automatically.
- Turn the milling spindle by hand so that the clamping screw (S) is accessible (see ⇒ Figure 18).
- Press the emergency stop button (4) and leave it locked.

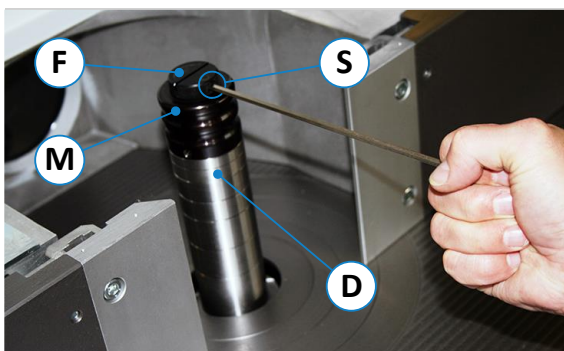

Figure 18: Milling arbor with quick clamping device

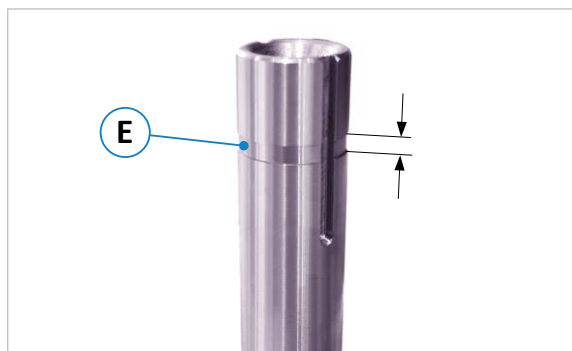





Figure 19: Marking for upper spacer ring

1. Loosen the clamping screw (S) on the quick-release nut (M) with the supplied SW4 pin spanner.
2. Then fully tighten the fixing screw (F) by hand and remove the quick-release nut (M) by taking it out. 
3. Remove the spacer rings (D) and put on the new cutter head.
4. Put on the required spacer rings (D), if necessary. Place enough spacer rings so that the upper clamping surface of the upper ring is in the area (E) of the marking groove shown in ⇒ Figure 19.
5. Then put the quick-release nut (M) back on and tighten the fixing screw (F) by hand.
6. Now tighten the clamping screw (S) with the SW4 pin spanner → Tightening torque = **12 Nm**.

 **Ensure that the clamping surfaces of the spacer rings and clamping nut are clean.**

 **With 12 Nm tightening torque of the clamping screw (S), the cutter is clamped with approx. 30 KN (= 3 t).**

After the tool change, unlock the emergency stop button (4) again.

14 Position the Milling Spindle

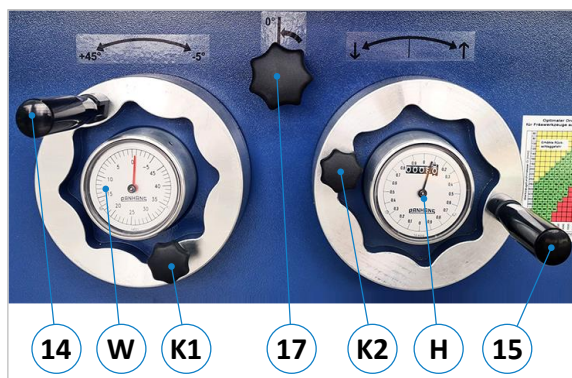

Figure 20: Handwheels for height / tilt adjustment

The positioning of the cutter height and spindle tilt is done via the two handwheels at the front, each equipped with an analogue dial gauge.

- **Left Handwheel** → Tilt adjustment in degrees
Graduation: 1.0°
- **Right Handwheel** → Height adjustment in millimetres
Graduation: 0.1 mm

14.1 Height Adjustment

- Open clamping star knob (K2).
- Adjust height with handwheel (15) via dial gauge (H).
- After adjustment, tighten the star knob (K2) again.



Please note: To compensate for spindle play during height adjustment, the position should always be approached from behind (loop). To do this, move a few millimetres beyond the target position and then back to the desired position.

14.2 Tilt Adjustment

- Open clamping star knob (K1)
- Adjust the tilt with the handwheel (14). The angle is indicated on the dial gauge (W).
Remark: For an angle $< 0^\circ$, the zero degree lock (17) must be turned to the left.
- After adjustment, tighten the star knob (K1) again.



The spindle for the tilt adjustment is preloaded with a gas spring. Manual spindle play compensation (as with the height adjustment) is not necessary for adjustment.

14.3 Zero-Degree Lock

The zero-degree lock (17) is used to precisely return the milling spindle from the inclined position to the vertical position (angle = 0°).

- Turn the star knob (17) to the right as far as it will go and hold it in this position.
- Turn the handwheel (14) clockwise (towards -5°) as far as it will go.

15 Milling Fences

15.1 Placing and Aligning the Milling Fence

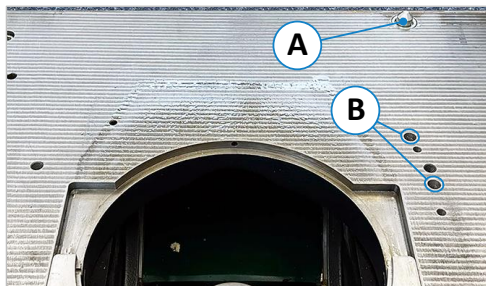

Figure 21: Locking bolts and detent holes

In order to place the fence on the table top and to align it parallel without the need for further tools, all fence types are equipped with a dovetail receptacle (S) on the underside and two spring-mounted centring pins (Z).

On the machine table surface there is the locking pin (A), which serves as a counterpart to the dovetail receptacle (S), and the two holes (B) into which the two above-mentioned centring pins (Z) can engage.

	<p>Increased risk of accidents due to the high weight of the fence! Lifting and placing the fence should be done by at least two people or with a suitable hoist (e.g. an indoor crane)!</p> <ul style="list-style-type: none"> • Danger of crushing hands and fingers between fence and machine table! • Wear protective gloves when lifting or placing the fence. • Acute risk of injury to the feet from the fence falling down! • Wear safety shoes with steel toe caps.
--	---

Placing and aligning the fence on the machine table is identical for both available fence types (215 and 216). The position of the centring pins (Z) is on the right side of the fence (seen from the front, refer to ⇒ Figure 21).

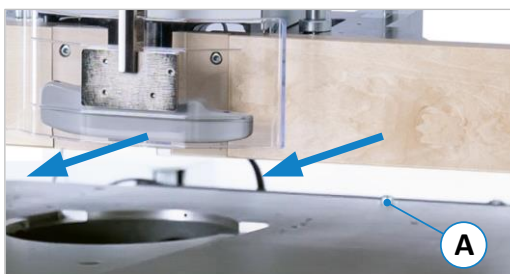

Figure 22: Move centrally over milling spindle

- Remove dirt and chips from the machine table and the underside of the fence.
- Move the fence over the machine table with the help of a second person, with a suitable hoist or with the optional Swivel-away device so that it is approximately centred over the milling spindle (see ⇒ Figure 22).
- Then move the fence slightly forward towards the operator's side so that its centre is a little in front of the milling spindle.

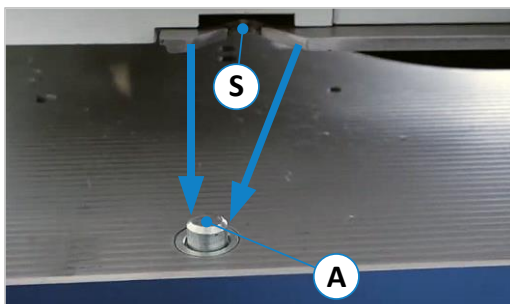

Figure 23: Align dovetail receptacle to locking pin

- Now stand on the back of the machine and pull the fence with the dovetail receptacle (S) as close as possible against the locking pin (A).
- Now set the fence down and move the rest by hand so that the locking bolt (A) engages securely in the receptacle (S) as shown in ⇒ Figure 23.
- To ensure parallelism with the machine table, turn the fence slightly until the centring pins (Z) on the underside of the fence (hidden in the view) engage in the holes (B) on the machine table (see ⇒ Figure 24). A slight click can be heard.

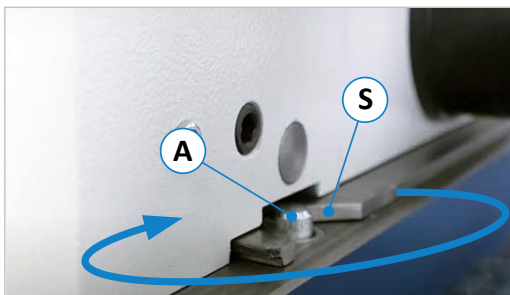

Figure 24: Lock and engage

Clamping the fence on the table:

- To fix the fence on the table top of the machine, attach and tighten both clamping levers (3) and (6). Refer to ⇒ Figure 25 resp. ⇒ Figure 26.

15.2 Functions and Adjustment of the Milling Fences

Two different fence types are available for the 245|10 tilting spindle moulder:

- **Fence Type 215 (standard)**
 - Total fence is manually adjustable via handwheel and partial fence via adjusting screw.
 - A separate measuring device is required to position the total fence (e.g. setting gauge).
 - The fence is equipped with multiplex fence plates.
 - No retrofitting with integral fence plates possible.
- **Fence Type 216 (option)**
 - Total fence is manually adjustable via handwheel and partial fence via adjusting screw.
 - The handwheel for the total fence is equipped with a digital, battery-operated position indicator.
 - The fence is equipped with cast iron fence plates and aluminium splinter tabs.
 - The fence type 216 can be retrofitted with integral fence plates if required.



Increased risk of accidents and collisions! The adjustment and setting processes described below may only be carried out when the milling cutter is stationary!



When milling with manual feed, a tool cover must always be used!



Remove chips and dust from the table top before adjusting the milling fence. For maintenance of your fence, please refer to section ⇨ 19.1.

15.2.1 Fence Type 215 (Standard)

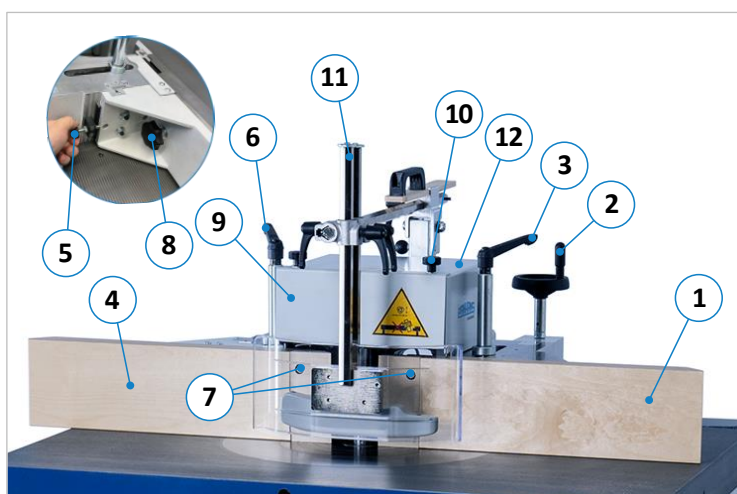

With type 215, the total and partial fence are manually adjustable. For adjustment, the clamping levers (3) and (6) are released and the fence is adjusted via the hand wheel (2). Afterwards the two clamping levers (3) and (6) must be re-tightened.

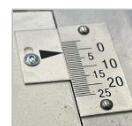

The partial fence can be adjusted by the adjusting screw (5) and read off on the vernier scale.

To position the total fence via handwheel, a separate measuring device is required (e.g. setting gauge or similar).

Figure 25: Operating elements Fence Type 215

Pos.	Description	Pos.	Description
1	Total fence plate (multiplex)	7	Splinter tabs
2	Total fence handwheel adjustment	8	Clamping star grip ¹ for fence plate adjustment
3	Total fence clamping lever	9	Sliding covers for high tools
4	Partial fence plate (multiplex)	10	Knurled screws for tool covers (9)
5	Partial fence adjusting screw ¹	11	Milling protection & pressure device
6	Partial fence clamping lever	12	Protective hood (unlocking rear left)

¹ The two star grips (8) as well as the partial fence adjustment screw (5) are located on the rear side.

15.2.2 Fence Type 216 (Option)

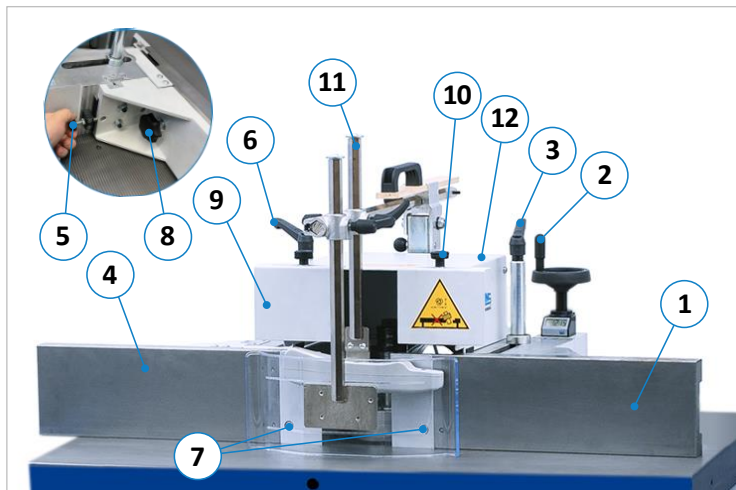

With the optional fence type 216, the total and partial fence are manually adjustable. For adjustment, the clamping levers (3) and (6) are released and the fence is adjusted via the hand wheel (2). Afterwards the two clamping levers (3) and (6) must be re-tightened.

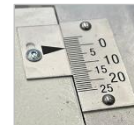

The partial fence can be adjusted by the adjusting screw (5) and read off on the vernier scale.

To visualise the actual position, the digital handwheel (2) of the total fence is equipped with a position indicator (details can be found in section ⇒ 15.5).

Figure 26: Operating elements Fence Type 216

Pos.	Description	Pos.	Description
1	Total fence plate (cast iron)	7	Aluminium splinter tabs
2	Total fence handwheel adjustment	8	Clamping ² star grip for fence plate adjustment
3	Total fence clamping lever	9	Sliding covers for high tools
4	Partial fence plate (cast iron)	10	Knurled screws for tool covers (9)
5	Partial fence adjusting screw ²	11	Milling protection & pressure device
6	Partial fence clamping lever	12	Protective hood (unlocking rear left)

15.3 Operating the Fences

The operation is identical for both fences (type 215 and 216). The only difference is that with type 215 (standard) a separate measuring device (e.g. setting gauge or similar) is required to position the total fence, whereas with type 216 (optional) the position can be read directly from the digital handwheel.

Information on operating the digital handwheel can be found in section ⇒ 15.5.

15.3.1 Fence plate adjustment

Loosen star grip (8) and push the fence plate (1) to the desired position. Then retighten star grip (8). Always adjust the plates so that they cover as much of the tool as possible without touching it.

15.3.2 Folding up the protective hood

Before the protective hood (12) of the fence can be folded up, the locking bolt (V) at the rear left must be unlocked by pulling it out (see ⇒ Figure 27).

15.3.3 Fit a grooved board or safety bar guides

To insert a grooved board or safety bar guides, remove the splinter tabs (7), attach the grooved board or safety bar guides as fence bridges and fasten them via the free threaded holes.



Figure 27: Locking bolt of Type 301

² The two star grips (8) as well as the partial fence adjustment screw (5) are located on the rear side.

15.3.4 Tool covers for high milling arbors

By opening the knurled screws (10), the two cover plates can be moved, which is particularly advantageous with high milling arbours. The opening should always be closed as far as possible without touching the milling arbor or the cutter.

15.3.5 Lifting off and removing the fence

- Remove clamping levers (3) and (6) by unscrewing them, lift off the fence and remove it.

Due to the heavy weight of the fence, this operation should be carried out by 2 persons or with a suitable hoist.

	<p>Increased risk of accidents due to the high weight of the fence! Lifting and placing the fence should be done by at least two people or with a suitable hoist (e.g. an indoor crane)!</p> <ul style="list-style-type: none"> • Danger of crushing hands and fingers between fence and machine table! • Wear protective gloves when lifting or placing the fence. • Acute risk of injury to the feet from the fence falling down! • Wear safety shoes with steel toecaps.
---	--

The fence can be lifted off and swivelled backwards even more easily, conveniently and safely with the optional swivel-away device (see next section ⇒ 15.4)

15.4 Swivel-Away Device Type 219 (Option)

The hydraulic swivel-away device ensures comfortable, safe lifting and swivelling of the milling fence. The device is mounted on the table top of the machine and can be locked with the supplied key. If the standard milling fence is not needed, e.g. for upcoming curved milling work with the curved milling fence (see ⇒ 15.6), it can be quickly lifted off the table and swivelled away to the rear without exerting force.

15.4.1 Swivel away the Milling Fence

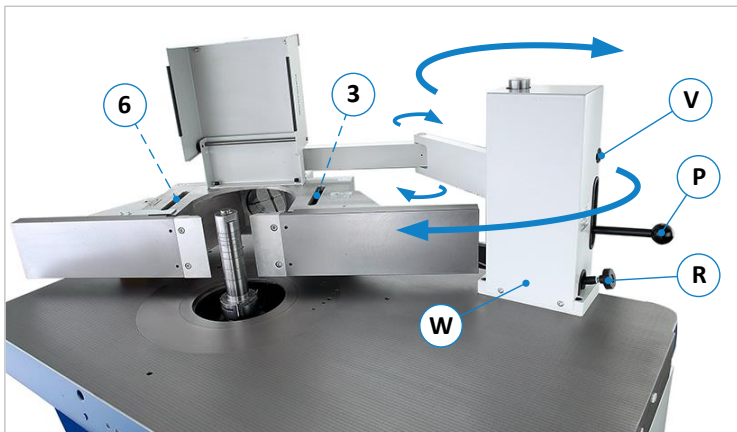

Lift off and swivel the milling fence:

- Position the total fence and the partial fence to 0 mm each.
- Remove the two clamping levers (3) and (6) by unscrewing them.
- Then unlock the lock (V). The key for this is on the back of the swivel-away device (W).
- Now the fence can be lifted off the table top and swivelled away by pumping it up with the lever (P).

Figure 28: Hydraulic swivel-away device

	<p>The fence must not be fixed to the tabletop when it is lifted, as this can lead to deformation of the swivel-away device. When lifting the fence, shake it slightly to loosen any jamming.</p>
---	--

Attach the milling fence back to the table top:

- To attach the milling fence back to the table top, proceed as described in section ⇒ 15.1.

Lowering is done by carefully turning the adjusting screw (R) anticlockwise. **Important:** In order to prevent damage when putting on the fence, do not lower the fence with the adjusting screw (R) too quickly.



15.5 Handwheel Adjustment for Type 216 (Option)



Figure 29: Digital handwheel

The fence type 216 is equipped with the digital handwheel "DE10". Via the LCD display, the total fence position can be read off directly at the fence with an accuracy of 0.1 mm.

Absolute / incremental measurement switchover:

- With the button  you can switch between incremental and absolute measurement.
- When the incremental measurement is active, the handwheel display also shows the symbol .



Please note: To compensate for the spindle play of the fence, the dimension should always be approached from behind (loop). To do this, move approx. 4 -5 mm beyond the target position and then back to the desired position.

15.5.1 Handwheel Battery Change

Operating times and the ambient conditions influence the battery life. The battery life is approx. 8 years. As soon as the battery symbol appears in the display, the battery should be replaced.

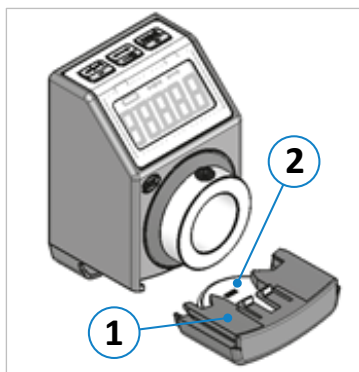

Figure 30: Battery change

- (1) Battery compartment
 - (2) Battery (polarity: - points upwards | + points downwards)
- The stored position value is retained when the battery is changed.



IMPORTANT: Observe polarity!

- **Incorrect polarity when inserting the battery leads to loss of the position value.**
- **Otherwise, the display unit must be recalibrated. For this, please contact our customer service under the telephone number 0049 7571 / 755 - 0.**

15.5.1.1 Preparation

Have the replacement battery ready → 3 V lithium button cell, type **CR2477**.

15.5.1.2 Disassembly

1. Pull out the battery compartment (1) to the front.
2. Remove the old battery (2) from the compartment.
3. Dispose of old battery.



Fire, explosion and burn hazard! Never recharge the battery used in the digital handwheel or expose it to temperatures above 85° C.



Used batteries must not get into fire, water or groundwater and must not be disposed of in household waste. Collect batteries and dispose of them in an environmentally friendly manner (e.g. in a battery collection container or at a battery collection point).

15.5.1.3 Assembly

1. Insert the new battery (+ must point downwards!)
2. Push the battery compartment (1) back in completely and check the function of the unit.

Further documents:

The original operating instructions for the "DE10" unit can be found via the following link:

☞ https://www.siko-global.com/adbimage/2642/asset_original/installation-instructions-de10.pdf

15.6 Ring Fence TAPOA 1639

The supplied TAPOA 1639 ring fence is used for accident-free milling of curved workpieces by means of a clamping template. It is suitable for spindle diameters of 30, 35, 40 and 45 mm and for tool diameters up to 160 mm. The ring fence can be quickly attached to the milling table and is easy to adjust. The transparent protective cover always allows an optimal view to the cutter head.



A clamping template must always be used for shaping the workpiece during curve milling. Only work with the ring fence when the extraction system is connected.

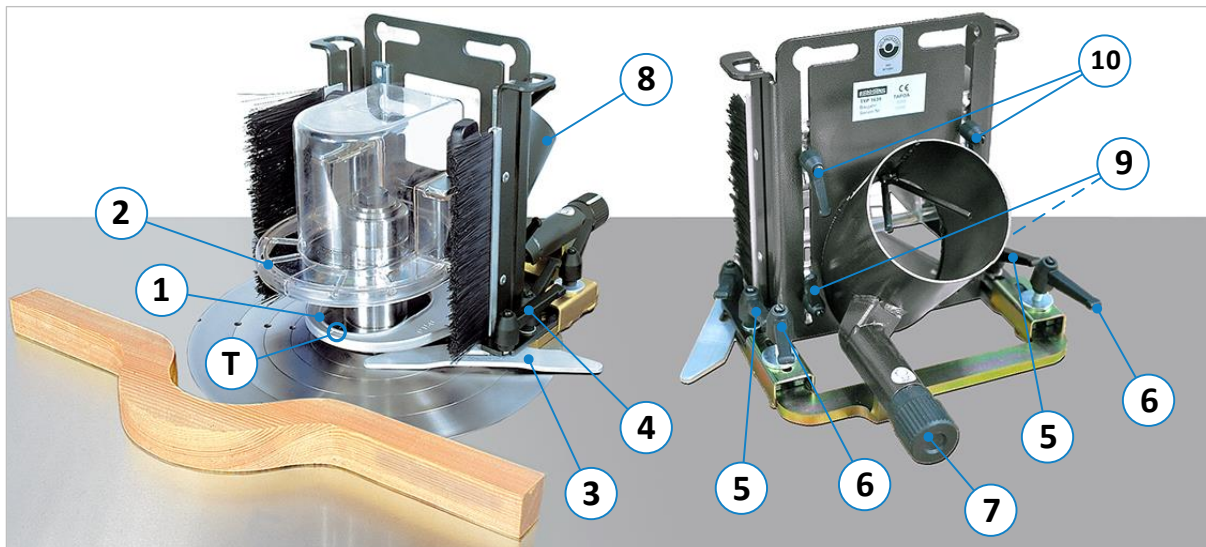

Figure 31: Operation elements of the ring fence TAPOA 1639

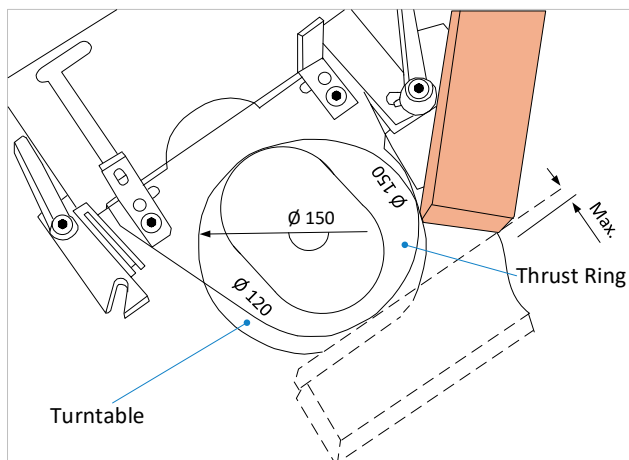

Figure 32: TAPOA 1639 ring fence adjustment

Adjust the thrust ring (1) so that the diameter printed on the inlet side corresponds closest to the diameter of the tool. To do this, the thrust ring may need to be rotated.

Example: With a tool diameter of 140 mm, the thrust ring must be installed as shown in ⇒ Figure 32.

- The height of the workpiece hold-down and the contact guard (2) are adjusted to the required level with the two clamping levers (10) on the rear side of the fence.
- The feed strip (3) can be swivelled away by loosening the clamping lever (4) if necessary. Further, it can also be mounted on the other side (with a different spindle rotation direction).
- The tangential point (T) is marked on the thrust ring. This mark is used to measure the maximum cutting depth. The adjustment is made by loosening the two clamping levers (5) and turning the adjusting wheel (7).
- The two brushes ensure that milling chips are wiped off and optimally extracted during work.
- After the adjustment work, always make sure that all screws and levers are tightened again.
- Before milling, check that the milling tool does not touch the fence.
- If the workpiece hold-down is worn, it must be replaced.

16 Protection and Pressure Devices



If no power feeder is used for milling, a protection and pressure device must be used.

16.1 TYPE 1629 GAMMA V (Standard)

The standard protection and pressure device type 1629 GAMMA V is suitable for all milling fences described in section ⇨ 15 and is smoothly adjustable horizontally and vertically and engages in folded-up position.

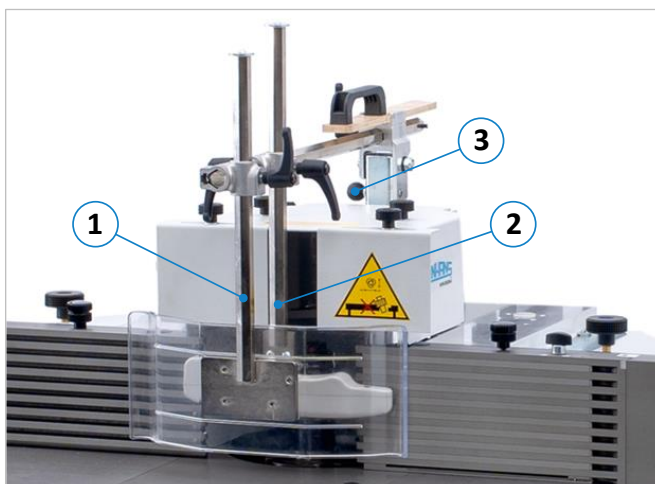

Figure 33: Protection and pressure device 1629 GAMMA V

- First adjust the milling fence to the respective tool diameter and the desired chip removal.
- Adjust the front, horizontal pressure piece (1) to the width of the workpiece and the rear, vertical pressure piece (2) to the height of the workpiece.

Remark: The two pressure pieces must form a tunnel through which the workpiece is pushed. Therefore, the adjustment must be made in such a way that the workpiece can be pushed through by hand under light pressure.

When not in use (e.g. when milling with a power feeder), the device is simply folded upwards. To do this, pull out the locking bolt (3) on the ball handle and swivel the device upwards until the locking bolt engages again.

16.2 TYPE 1624 CENTREX (Option)

The protection and pressure device type 1624 CENTREX is used for the safe fixing of workpieces during manual milling operations. It fits all the milling fences described in section ⇨ 15 and can be used instead of the standard protection and pressure device 1629 GAMMA V. The special shape of the pressure shoes ensures precise workpiece guidance for all milling work. The device can be folded up and is attached to the milling fence.



Figure 34: Protection and pressure device 1624 CENTREX

- First adjust the milling fence to the respective tool diameter and the desired chip removal.
- Then loosen the clamping wheel (3) and (4) and put the pressure shoe (2) upwards.
- Adjust the pressure shoe (1) to the workpiece width, pretension and tighten the clamping wheel (3).
- Adjust the pressure shoe (2) outside the knife-edge circle to the height of the workpiece, pretension and tighten the nut (4).
- Adjust the pressure shoe (1) to the workpiece height for milling wide or flat workpieces and for milling end faces.

When not in use (e.g. when milling with a power feeder), the device is simply folded upwards. To do this, pull out the locking bolt (3) and swivel the device upwards until the locking bolt engages again.

The article number can be found in the section ⇨ 21.3 "Milling Fences".

17 Optional Components

17.1 Integral Fence System for Fence Type 216

The optional milling fence 216 can additionally be equipped with optional integral fence plates. These can be mounted without tools and in just a few steps instead of the standard cast fence plates.

The swivelling guide fingers integrated in the fence plates always ensure a gap-free guide surface and optimum tool coverage for all milling work. This ensures even more safety.

Precise adaptation to the diameter and height of the cutter is achieved by the stepless adjustment.



Figure 35: Integral fence plates (option)

17.1.1 Operation and Functions

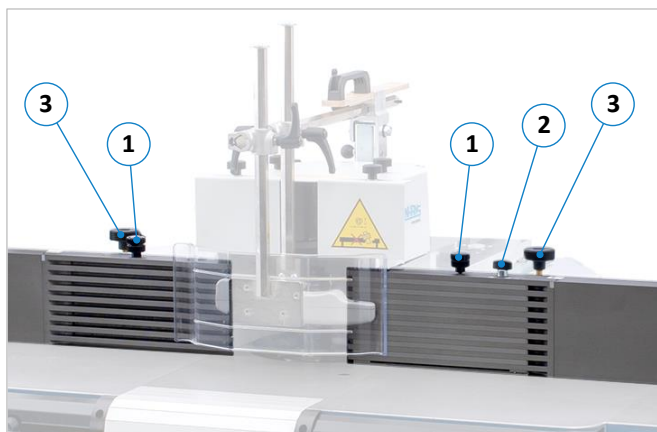

Figure 36: Integral fence plates - operation and functions

Pos.	Function
1	Height adjustment
2	Fold out guide fingers
3	Move fence plates

The integral plates are available in 3 lengths:

- Infeed/outfeed side = 500 / 500 mm
- Infeed/outfeed side = 650 / 500 mm
- Infeed/outfeed side = 650 / 650 mm

The article numbers can be found in the section ⇒ 21.3 “Milling Fences”.

17.2 Table Slide Plate

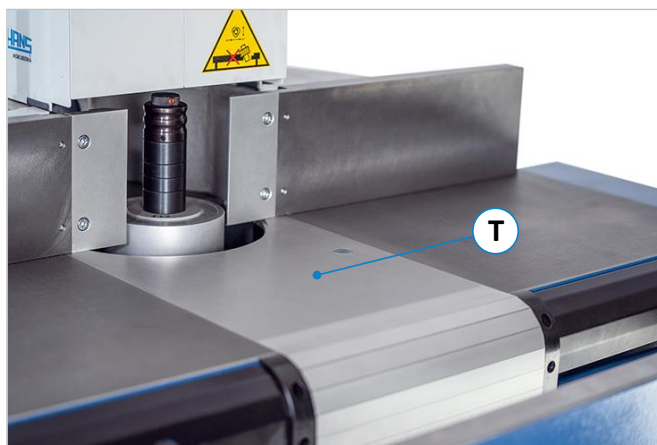

Figure 37: Optional Table Slide

The patented table slide plate (T) has coated surfaces and ensures a safe and quickly adjustable tool protection without the need for further tools. It is used as an alternative to the standard table insert rings and can be adapted to various tools up to \varnothing 240 mm.

Includes front table insert with quick-locking device for tools up to \varnothing 155 mm and a rear insert for closing the table opening. The table slide plate is available for the standard table top and for the larger, optional table top.



WARNING: Danger of collision!

When adjusting the tilt of the spindle, the table slide plate must always be completely open.

The article number can be found in the section ⇒ 21.2 “Table Systems”.

Please note: The table slide plate cannot be used in combination with the optional turntable.

17.3 Safety bar guides for the Milling Fence



Figure 38: Safety bar guide set

The optional safety bar guides serve as a continuous guide between the two fence plates. The set consists of:

- 2 safety bar guides 260 x 6 mm
- 3 safety bar guides 260 x 3 mm,
- 1 grooved board (multiplex) 260 x 150 x 12 mm, incl. sliding blocks and Allen key

The article number can be found in section ⇒ 21.3.

17.4 Swivel-Away Device for the Milling Fence

- For detailed description, operation and function refer to section ⇒ 15.4.
- Article number see section ⇒ 21.3 „Milling Fences“.

17.5 Turntable (360 degrees) for the Milling Fence

When ordering this option, the turntable (1) is already installed on the machine at the factory. The 360° rotation range allows the milling fence to be flexibly rotated in all directions on the machine table.

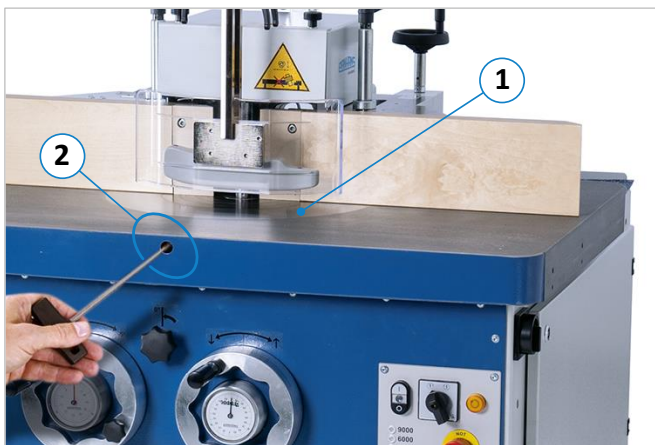

Figure 39: Turntable with opening for clamping

- At the front of the machine there is an opening (2) with a clamping screw for fixing the turntable.
- Loosening and clamping is done with an SW6 pin spanner.

Please note:

- The turntable cannot be retrofitted.
- The turntable cannot be used on machines with optional table slide.

The article number can be found in the section ⇒ 21.2 “Table Systems”.

17.6 Extendable Frame Support

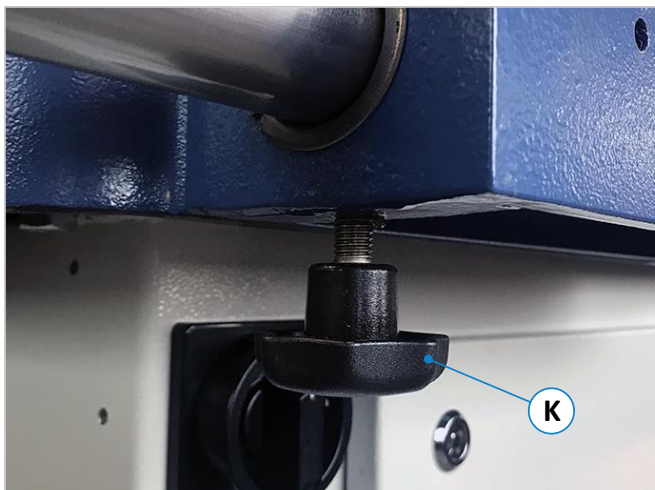

Figure 40: Clamping lever for extendable frame support

The table top with dimensions 1100 x 760 mm can optionally be equipped with an extendable frame support.

- Total length approx. 1375 mm
- Extension depth approx. from the centre of the milling spindle.
- Guided in separate bearing blocks at the side of the machine table.

The table is clamped by means of the two star grips (K) which are located on the left and right side of the table below the extension rods.

The article number, table extensions and other table systems can be found in section ⇒ 21.2 “Table Systems”.

17.7 TM 100 - RFID based Machine Access Control System



Figure 41: TM 100 - Machine Access Control System

The TM 100 key system offers the highest level of security. With the user data bank, only authorised personnel can start the machine by using a personalised RFID key.

Included is the TM 100 system with master key (red) for administrator access and four user keys (blue) for authorised persons who are allowed to work on the machine.

Additional user keys can be ordered.

The article numbers of the system and supplementary accessories are listed in section ⇨ 21.7.

17.8 Tenoning and Slotting Device Type 1376

The tenoning and slotting device 1376 is used for tenoning and slotting on the tilting spindle moulder. It is usually already factory-fitted to the table top of the machine. The integrated mitre fence can be swivelled by 60° to both sides and enables angular cuts from 30° to 150°. The smooth-running, ball-bearing sliding carriage has a sliding length of 710 mm (sliding panel length = 295 mm, slide panel width = 255 mm).

	<p>Increased risk of accidents due to the high weight of the device! Lifting and placing should be done by two persons or with a suitable hoist (e.g. indoor crane)!</p> <ul style="list-style-type: none"> • Danger of crushing hands and fingers between the device and the machine table! • Wear protective gloves when lifting or placing the device. • Acute risk of injury to the feet if the device falls down! • Wear safety shoes with steel toe caps.
---	--

Note for possible retrofitting: If the device is retrofitted later, it must be mechanically adapted to the machine table on site. For this purpose, the table top must be provided with corresponding threaded holes. For procedure and drilling sketch refer to section ⇒ 17.8.3.

17.8.1 Operation

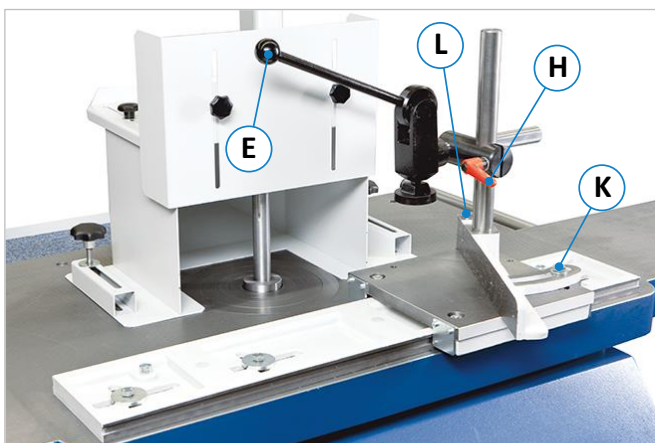

Figure 42: Tenoning guard 1376

Workpieces to be machined can quickly and securely be fixed on the slide with the eccentric clamp (E). The position of the eccentric clamp can be adjusted to the respective workpiece. To adjust, loosen the clamping levers (H).

The bearing screw (L) and the clamping screw (K) are used to adjust angles. Depending on the desired angle range, these can be shifted accordingly to the table in section ⇒ 17.8.2.

Maintenance see section ⇒ 19.2.
Article number see section ⇒ 21.5.

17.8.2 Table for Angular Cuts

Demanded cutting angle	30° ... 90°		90° ... 150°	
Bearing point	L		L1	
Clamping point	K	K1	K2	K3
Cutting angle range	30°... 56°	56°... 90°	90°... 124°	124°... 150°

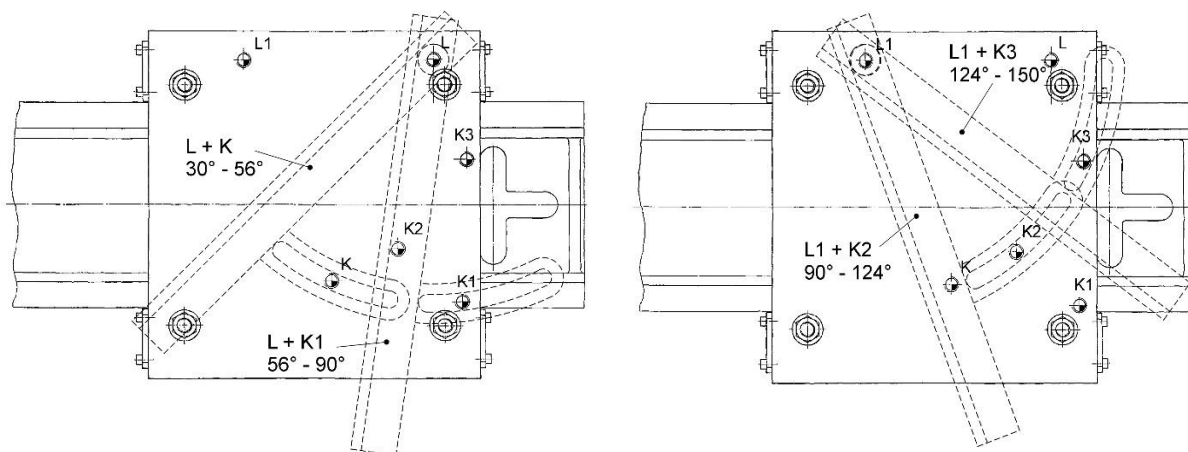

Figure 43: Angle ranges (position of the screws)

17.8.3 Adaptation to the Machine Table (only required for retrofitting)

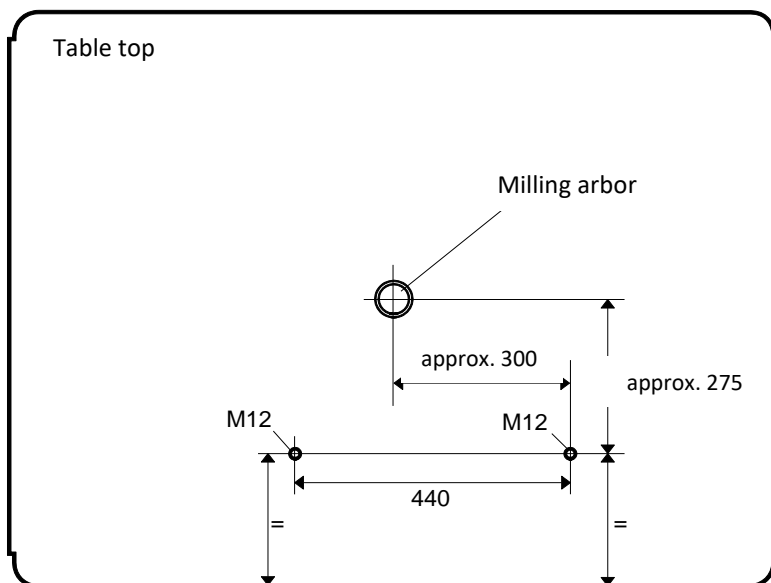

Figure 44: Adapt tenoning device (drilling sketch)

Mount the tenoning and slotting device as close as possible to the milling arbor.

The diameters of the largest and smallest cutter heads used are decisive for the distance to the milling arbor.

- Place the tenoning device on the machine table (parallel to the table edge).
- Determine the distance to the milling arbor and mark the centre of the crossed slotted holes on the table top.

We recommend drilling the holes according to the sketch above, whereby the dimension 275 mm depends on the cutter head diameter used.

- For this purpose, two M12 threads must be fitted (bore diameter = 10.2 mm).
- Fasten the tenoning device with M12 x 30 hexagon screws and washers.

17.8.4 Supplementary Protective Cover 1641 (Option)

The protective cover type 1641, also shown in ⇒ Figure 42, is an ideal complement to the tenoning and slotting device type 1376. It is suitable for tenon cutting and slotted discs up to max. 350 mm. The cover is made of strong sheet steel and has an adjustable protective hood as well as an extraction nozzle with an outer diameter of 120 mm. For article number see section ⇒ 21.5.

17.9 Kickback Guard Type 1648



Figure 45: Kickback guard type 1648

The kickback guard type 1648 is used for accident-free insertion milling of long and short parts in combination with the optional table extension.

It is infinitely adjustable from 0 to 1500 mm and intuitive to operate.

Article number see section ⇒ 21.2.

17.10 Power Feeders



For safety reasons, a power feeder should be used whenever possible.

Generally applies: Always adjust the power feeder so that the workpiece is guided safely along the fence. Set the unit at an angle of approx. 5° to the feed direction and keep the opening to the fence as small as possible.



Figure 46: Power feeder type PV84

- Power feeder with 4 rollers (120 x 60 mm)
- 8 adjustable feeding speeds (2/4/5,6/6,7/11/13/16,5/33 m/min)
- Clockwise/anti-clockwise rotation
- Stand with an max. outreach of 1,050 mm by an elongated extension arm
- Metal gearbox for setting four additional speeds
- Can be used individually horizontally and vertically
- incl. mounting, cable and plug



Figure 47: Power feeder type Variomatic 4N

- Power feeder with 4 rollers,
- Infinitely variable feed speed from 2 - 18 m/min as well as clockwise/anti-clockwise rotation
- Rotate to insert horizontal/vertical.
- Max. outreach of 1,050 mm
- Easy swivelling away and positioning with memory lock system.
- With comfort stand and numerical height display
- incl. mounting, cable and plug

Both models are supplied with 400 volts and can be connected to the existing machine socket. For further information on operation and functionality, please refer to the separately enclosed  *Operating manual of the corresponding manufacturer.*

The article numbers can be found in the section \Rightarrow 21.6.

17.10.1 Rigid Console for Power Feeders

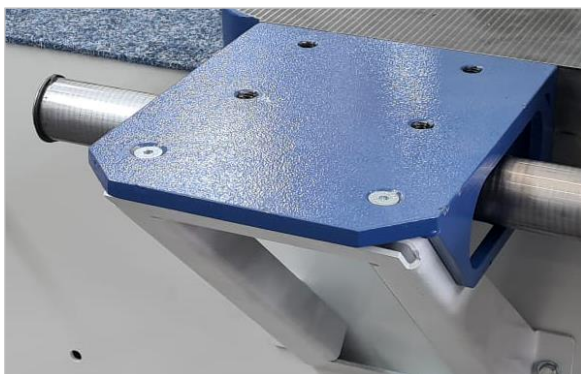

Figure 48: Console rigid

Rigid add-on console for a power feeder. The platform (approx. 195 x 180 mm) is mounted on the left side of the table top.

The article number can be found in section \Rightarrow 21.6.

18 Troubleshooting

Proceed systematically when searching for the cause of a malfunction. If you are unable to find the fault or to remedy the malfunction, contact our customer service department (phone number: 0049 7571 / 755 – 0).

Before you call us, please follow these steps:

- Make a note of the type, machine number and year of production (see nameplate).
- Keep this operating manual (and any circuit diagrams) to hand.
- Describe the fault to us in detail so that a competent remedy can be found.

Fault	Possible Cause	Remedy
Machine does not start	No voltage	→ Check power supply
	Control fuse defective	→ Replace fuse (⇒ wiring diagram)
	Main switch defective	→ Replace main switch
	Drive motor defective	→ Replace motor
	V-belt defective/loose	→ Replace or tighten belt (see section ⇒ 19.4)
	Motor protection switch has tripped	→ Set protection switch "OFF" and then "ON" again
	Emergency stop button pressed	→ Pull/unlock button
	Service door is open	→ Close door & lock the safety switch
	Safety switch of the service door is unlocked	→ Lock the door safety switch (see section ⇒ 11.5)
Spindle comes to a stop unbraked	Brake pads worn or brake is defective	→ Readjust brake (see ⇒ 19.4) → Replace brake (customer service)
Speed indicator does not light up	Signal lamp defective	→ Replace signal lamp (electrician!)
	Fuse defective	→ Replace fuse (electrician!)
	Transformer defective	→ Replace transformer (electrician!)
	Fork switch (speed fork) defective	→ Replace defective part (electrician!)

19 Maintenance and Inspection



Before any maintenance and inspection work is carried out, chapter ⇒ 5 "Safety" must be read carefully and observed!

Operational malfunctions caused by insufficient or improper maintenance can result in very high repair costs and long machine downtimes. Regular maintenance is therefore essential.

- Clean the machine daily.
- Check all sliding or rolling parts weekly for smooth running and lubricate with a thin-bodied oil if necessary.
- Inspect electrical equipment/components weekly for externally visible damage and have them repaired by a qualified electrician if necessary.
- Immediately remove and replace damaged guards. Never work with damaged equipment!
- Before starting work, check the extraction system for full function every day.
- The extraction system must be checked for obvious defects before initial commissioning, daily and monthly to ensure its effectiveness.
- The air velocity to the extraction system must be checked before the initial commissioning and after significant modification.
- If the motor no longer brakes within 10 seconds when switching off, it is essential to contact the customer service.
- Do not use the machine until these conditions are met.

Due to the different operating conditions, it is not possible to determine in advance how often a wear check, inspection or maintenance is required. Inspection intervals are to be determined appropriately according to the respective operating conditions.

Please also read section ⇒ 19.3 "Maintenance Plan".

19.1 Maintenance of the Milling Fence

The milling fence should be cleaned thoroughly at regular intervals. The contact surfaces between the milling fence and the fence plates and between the milling fence and the table top are particularly important. Dust can accumulate at these points. This can lead to inaccuracies when positioning the milling fence.

19.2 Maintenance of the Tenoning and Slotting Device Type 1376 (Option)

Regularly clean all moving parts from dust and dirt and lubricate with a thin-bodied oil. If the tenoning and slotting device is not used for a longer period of time, the bare parts should be covered with a light film of oil to protect them from corrosion.

19.3 Maintenance Plan

Activity	daily	weekly	monthly	annually
Cleaning the machine	X			
Check that the extraction system is fully functional before starting work.	X			
Inspect electrical equipment and components for externally visible damage and have this repaired by a qualified electrician if necessary.		X		
Check drive belt condition.			X	
Check drive belt tension.			X	
Check all sliding and rolling parts for smooth running and lubricate with a thin-bodied oil if necessary.		X		
Apply a few drops of oil to the threads of the clamping & adjustment levers.		X		
Clean swivel segments from resin and wood residues and lubricate with a thin-bodied oil (e.g. Neoval).		X		
Lubricate the milling spindle bearings at the marked points (see section ⇨ 20.2).			X	
Check the milling fence for damage and replace damaged parts if necessary.			X	
Replace the lubricator of the swivel adjustment (for detailed procedure see section ⇨ 20.1).				X
Check the TAPOA 1639 ring fence for damage and replace damaged parts if necessary.	Always before use			

In addition to the maintenance plan, please also follow the section ⇨ 20.2 “Lubrication Plan”.

19.4 Readjust the Motor Brake

The machine is equipped with a mechanical motor brake. After approx. 10,000 braking operations or if the machine no longer comes to a standstill within 10 seconds when braking, the motor brake must be adjusted.



Switch off the machine during maintenance and repair work and secure it against being switched on again unexpectedly! Lock the main switch with a padlock!

Procedure:

- First, the milling spindle must be swivelled fully forwards via the control (position +45.5°)
- Then turn the main switch (1) off and lock it.
- Open the front service door.
- A socket spanner SW 17 is required for adjustment.
- Put the socket spanner on the adjusting nut (⇒ Figure 49) and adjust it clockwise by approx. 1/8 turn.



Figure 49: Adjusting screw of the motor brake

19.4.1 Check the Adjustment

- Before checking the adjustment, make sure that the belt is well tensioned (see ⇒ 19.5.1).
- Then unlock the main switch (1) again and switch it on (position "I"):
→ It must now be possible to move the V-belt pulley by hand. By turning it, you can now check whether the brake is dragging, which means that it has been adjusted too excessively.
→ If the brake is dragging, the readjustment made must be minimally reversed again.
- Start the spindle motor and wait until the machine has reached full speed.
- Then switch off the machine and check the braking time to standstill.
- If the braking time is still over 10 seconds, repeat the adjustment procedure (see section ⇒ 19.4) and check the adjustment again.
- If the adjustment was not successful, please contact the customer service of the manufacturer.



If rattling noises occur in the area of the fan blade when turning the motor, please contact customer service. Possibly the brake lining is worn out.

19.4.2 Replace Motor Brake

If the previously described adjustment of the motor brake was not successful, the motor brake must be replaced. First make a note of the type designation and other information on the nameplate of your motor. Then contact our customer service (telephone 0049 - 7571 / 755 - 0) to order a suitable new brake.

19.5 Change and Tighten the Drive Belt



Switch off the machine during belt replacement and tightening and secure it against unintentional restarting! Lock the main switch with a padlock!

The drive belt should be replaced in the event of excessive wear, frayed flanks, traces of oil, porosity or if cross-sectional fractures are present.

Change drive belt and tighten the new one

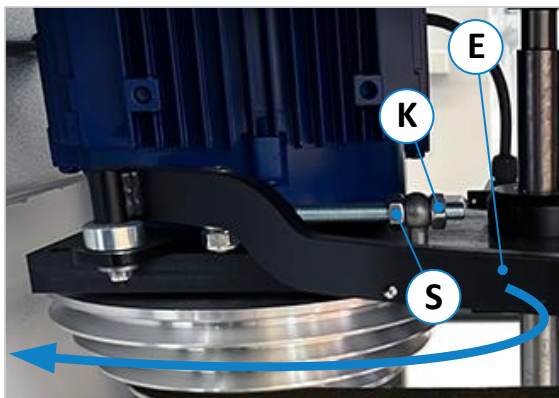

Figure 50: Tightening drive belt

1. Open the front service door.
2. Swivel the lever (E) all the way in the direction of the arrow to release the belt. **Important:** If the worn out belt has already been retightened, additionally loosen the counter nut (K) and reduce the belt tension by turning the adjusting screw (E) anticlockwise ↺. This is necessary to prevent the new belt from overstretching.
3. Remove the old belt and fit a new one (for speed setting, refer to section ⇒ 12).
4. **Important:** Before tightening, make sure that the belt is correctly positioned in the speed fork again.

5. The correct belt tension for the new belt is set using the adjusting screw (S). To do this, approach it step by step by first tightening the adjusting screw (S) only slightly in clockwise direction, swinging the lever (E) back again and then checking the belt tension. Repeat this procedure until the correct belt tension (according to section ⇒ 19.5.1) is achieved.
6. Then tighten the lock nut (K) again and swivel the lever (E) back to its original position.

Tighten drive belt

1. Swivel the lever (E) all the way in the direction of the arrow to make it easier to tighten the belt.
2. Loosen the counter nut (K) and set the correct belt tension with the adjusting screw (S).
To do this, proceed as described above in step 5.
3. Then tighten the lock nut (K) again and swivel the lever (E) back to its original position.

19.5.1 Checking the Drive Belt Tension

The correct pretension of the drive belt can be checked as follows:

4. Press the drive belt (in the middle between the two belt pulleys) from above with a strong thumb pressure (approx. 2 kg).
5. With correct pretension, the belt must only be able to be pushed downwards (X) by max. 5 mm.
6. If a new belt is installed, it must only be possible to push it downwards (X) by max. 2 mm.

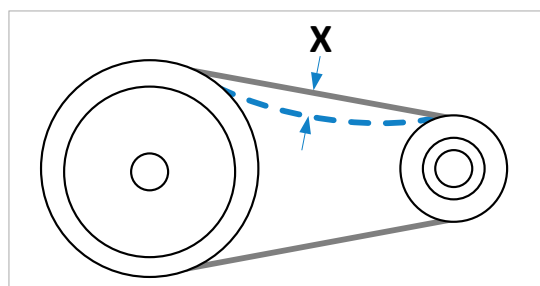

Figure 51: Checking the belt tension



**Too low belt tension leads to increased wear or failure of the belt.
Excessive belt tension can cause bearing damage to the drive axes.**

20 Lubrication Instruction

The machine has been extensively test-run at the factory and is lubricated ready for operation. Relubrication before commissioning is therefore not necessary. For subsequent lubrication, use only special grease, e.g.:

- **PANHANS ZET-GE-MSO**
- **ARCANOL BN 102**
- **CALYPSOL H 442 B**
- **SHELL ALVARIA 3**

For oil lubrication we recommend:

- **Motor oil 20 W 40**

Always use the same grease/oil type.

- Check all sliding or rolling parts weekly for smooth running and lubricate with a thin oil if necessary.
- Apply weekly a few drops of oil to the threads of the clamping and adjustment levers.

20.1 Change Lubricator

The lubricator is constructed in such a way that the lubricant is dispensed within one year.



Switch off the machine before changing the lubricator and secure against unintentional restarting! Lock the main switch with a padlock!

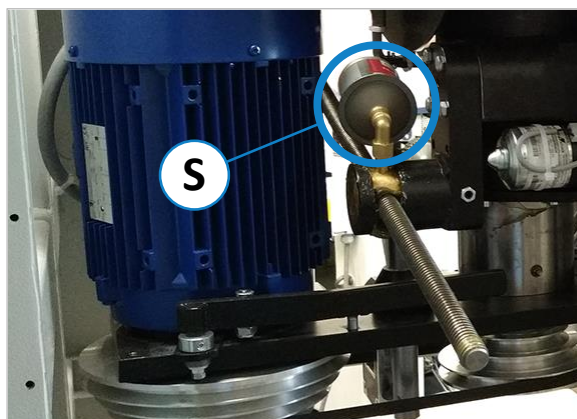

Figure 52: Change lubricator

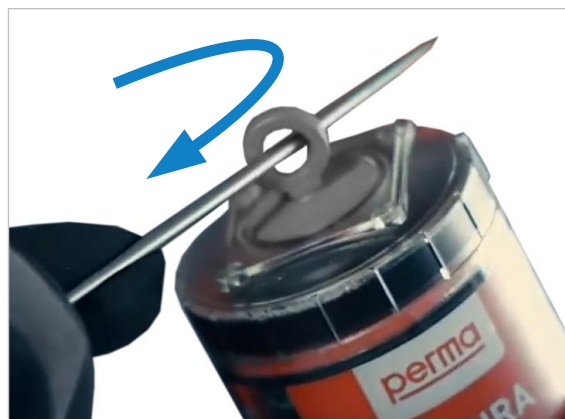

Figure 53: Activation with activation screw

- Open the front service door and unscrew the used lubricator (S) from the lubrication point.
- Remove the cap of the new cartridge. Release lubricant dispensing by screwing in the activating screw with a suitable tool, until the O-ring breaks off (see ⇒ Figure 53 on the right).
- Then shake the cartridge well to check the activation. If the activation is correct, a clear "clicking" sound should be heard.
- Before installation, write the replacement date into the intended field of the lubricator label.
- Now screw in the new lubricator by hand.
- The lubricant dispensing period is 12 months.



Please ensure that no dust or dirt gets into the bore of the cartridge holder as long the lubricator is unscrewed!



Once the lubricator has been activated, lubricant dispensing can no longer be interrupted!

Please also read the next section ⇒ 20.2 "Lubrication Plan".

20.2 Lubrication Plan

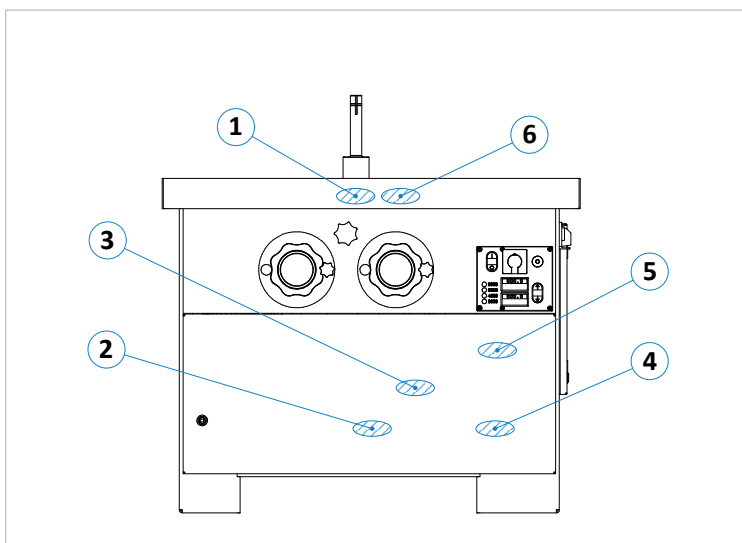

Figure 54: Lubrication points on the machine



Figure 55: Central lubrication



To keep the machine parts always clean and in perfect condition, excess and/or old grease must be wiped off at the outlet points of all existing grease nipples and other guiding elements!

Standard Version

Pos.	Lubrication Point	Access	Lubrication Interval / Dosage
1	Milling spindle bearing (top)	Move the spindle all the way up and remove the insert rings or table slider	monthly / 2 grease shots
2	Milling spindle bearing (bottom)	Open front service door	monthly / 2 grease shots
3	Height adjustment bearing (top)	Open front service door	monthly / 2 grease shots
4	Height adjustment bearing (bottom)	Open front service door	monthly / 2 grease shots
5	Chain system of the height adjustment	Open front service door	monthly / lightly oil
6	Swivel segment guides ³ (both sides)	Access from above, before remove insert rings / table slider	weekly / lubricate with fine oil

With Central Lubrication (Option)

Pos.	Lubrication Point	Access	Lubrication Interval / Dosage
1	Milling spindle bearing (top)	Move the spindle all the way up and remove the insert rings or table slider	monthly / 2 grease shots
6	Swivel segment guides ³ (both sides)	Access from above, before remove insert rings / table slider	weekly / lubricate with fine oil

In addition to the lubrication plan, please also refer to the section ⇨ 19.3 “Maintenance Plan”.

³ Remove resin and wood residues from the swivel segments once a week.

21 Options and Accessories

In the following tables you will find available options and accessories to upgrade your machine. You can find general spare parts in our online shop on <https://www.hokubema.com>.

	<p>Use only the tools, accessories and spare parts specified by the manufacturer. The use of other tools, accessories or spare parts may cause injury to persons and damage to the machine. The manufacturer accepts no liability for any damage resulting from the use of tools, accessories or spare parts not specified by the manufacturer or from additional components supplied by third parties!</p>
---	--

21.1 Technical Extensions

Article	Description	Art. No.
MOTOR¹⁶	Motor 7.5 kW (10 HP) instead of 5.5 kW.	4271

21.2 Table Systems

Article	Description	Art. No.
TURNTABLE	This allows the milling fence types 215 and 216 to be rotated 360° on the machine tables with 1100 x 760 mm table top.	4466
SLIDE PLATE FOR TABLE TOP 1100 X 760 MM	With coated surfaces. For fast, comfortable and tool-free adjustment to different tool diameters up to max. 240 mm, incl. front table insert with quick lock up to tool diameter 155 mm and rear insert for closing the table opening. Can be used instead of the standard table insert rings (not in combination with rotary table art. no. 4658).	4467
SLIDE PLATE FOR TABLE TOP 1340 x 800 MM	Similar to Art. No. 4467, but for larger table (availability on request!)	4660
EXTENDABLE FRAME SUPPORT FOR TABLE TOP 1100 X 760 MM	Total length approx. 1375 mm, extension depth approx. 892 mm from the centre of the milling spindle, smooth-running, guided in separate bearing blocks on the side of the machine table.	4232
TABLE EXTENSION ON BOTH SIDES	For table top 1100 x 760 mm , Total length 2300 mm, consisting of 2 pieces of finely planed cast iron table tops as extension each on the left and right of the standard machine table, with smooth-running frame support approx. 892 mm, extendable to the front.	4630
TABLE EXTENSION ON BOTH SIDES	For table top 1340 x 800 mm , Total length 2500 mm, consisting of 2 pieces of finely planed cast iron table tops as extension each on the left and right of the standard machine table, with smooth-running frame support approx. 970 mm, extendable to the front	4215
TABLE EXTENSION ONE-SIDED RIGHT	For table top 1340 x 800 mm : Finely planed cast iron table top as extension on the right side of the standard machine table, thus total length = 1950 mm, with smooth-running frame support approx. 970 mm, extendable to the front.	4217
LARGE TABLE TOP, SIZE 1340 X 800 MM, WITH TURNTABLE	Including frame support 1340 mm, extendable to approx. 970 mm, instead of standard table top 1100 x 760 mm. Table slide plate not possible! Additional option: table top extension Art. No. 4215.	4423
LARGE TABLE TOP, SIZE 1340 X 800 MM, WITHOUT TURNTABLE	Including frame support 1340 mm, extendable to approx. 970 mm, instead of standard table top 1100 x 760 mm. Table slide plate not possible! Additional option: table top extension Art. No. 4215.	4423.1
KICKBACK GUARD TYP 1648	For safe insert milling of long and short parts, infinitely adjustable from 0 - 1500 mm, for milling machines with existing table extension.	2002

21.3 Milling Fences

Article	Description	Art. No.
MILLING FENCE 216	Instead of standard milling fence type 215. Made of die-cast aluminium with plane-milled cast iron fence plates with aluminium splinter tabs, length 500 mm; to accommodate optional safety bar guides and mouldboard. Total adjustment via digital handwheel, adjustment of the partial fence plate via star grip and scale (+5 ... -25 mm), max. tool diameter 250 mm.	4274
HYDRAULIC SWIVEL-AWAY DEVICE	For comfortable and safe lifting and swivelling of the milling fence type 215 / 216 into a neutral position without using force. Recommended: Additional console for power feeder Art. No. 4561	4349
1 SET SAFETY BAR GUIDES FOR MILLING FENCES	As continuous guide between the two fence plates consisting of: 2 pieces rulers 260 x 6 mm, 3 pieces rulers 260 x 3 mm, 1 grooved board (multiplex) 260 x 150 x 12 mm, incl. sliding blocks and Allen key.	2093
INTEGRAL FENCE SYSTEM INFEEED/OUTFEED SIDE 500 + 500 MM <i>(only for fence type 216)</i>	The swivelling guide rods integrated in the fence plates ensure a guide surface without gaps for all milling operations; the exact adjustment to the tool diameter and height is achieved by a stepless adjustment. Usable instead of standard cast fence plates.	4170
INTEGRAL FENCE SYSTEM INFEEED/OUTFEED SIDE 650/500 MM <i>(only for fence type 216)</i>	The swivelling guide rods integrated in the fence plates ensure a guide surface without gaps for all milling operations; the exact adjustment to the tool diameter and height is achieved by a stepless adjustment. Usable instead of standard cast fence plates.	4169
INTEGRAL FENCE SYSTEM INFEEED/OUTFEED SIDE 650/650 MM <i>(only for fence type 216)</i>	The swivelling guide rods integrated in the fence plates ensure a guide surface without gaps for all milling operations; the exact adjustment to the tool diameter and height is achieved by a stepless adjustment. Usable instead of standard cast fence plates.	4171
CENTREX MILLING PROTECTION AND PRESSURE DEVICE	For secure fixing of workpieces during manual milling work; the special shape of the pressure shoes ensures precise workpiece guidance during all milling work, attached to the milling fence, can be folded upwards. Usable instead of the standard protection and pressure device GAMMA V 1629.	2220

21.4 Milling Spindles and Arbors

Article	Description	Art. No.
MILLING SPINDLE Ø 1 ¼"	Not interchangeable, dynamically balanced for optimum concentricity, clamping height 140 mm with cutter arbor rings and cutter quick-clamping device via Allen key with anti-rotation lock, instead of 30 mm standard milling spindle.	4153
MILLING SPINDLE Ø 35 MM	Not interchangeable, dynamically balanced for optimum concentricity, clamping height 140 mm with cutter arbor rings and cutter quick-clamping device via Allen key with anti-rotation lock, instead of 30 mm standard milling spindle.	4150
MILLING SPINDLE Ø 40 MM	See Art. No. 4150, but clamping height = 160 mm.	4151
MILLING SPINDLE Ø 50 MM	See Art. No. 4150, but clamping height = 160 mm.	4152

21.5 Tenoning and Slotting Device

Article	Description	Art. No.
TENONING AND SLOTING DEVICE 1376	Mounted on the machine table for light tenoning and slotting work with eccentric clamp and adjustable mitre fence. Sliding length = 710 mm, height above table approx. 56 mm.	4547
PROTECTION COVER 1641	Protection cover for the tenoning and slotting device 1376, suitable for tool diameters from 250 to 350 mm, with suction nozzle Ø 120 mm.	2235

21.6 Power Feeders and Consoles

Article	Description	Art. No.
POWER FEEDER PV 84	4 rollers 120 x 60 mm, right and left rotation, stand with extension arm L = 1050 mm, 8 speeds: 2/4/5,6/6,7/11/13/16,5/33 m/min, can be used individually horizontally and vertically, incl. mounting, cable and plug.	4029
POWER FEEDER VARIOMATIC 4 N	4 rollers, infinitely variable feed speed from 2 - 18 m/min clockwise and anti-clockwise rotation, quick turning from horizontal to vertical use. Easy swivelling away and positioning with memory lock system. With comfort stand, numerical height display, extension arm L = 1050 mm, incl. mounting, cable and plug.	4638
RIGID CONSOLE	For mounting a power feeder, size approx. 195 x 180 mm, mounted laterally on the left of the table top. Mandatory when using the milling fence types 216 with integral fence plates 650 + 650 mm with table top size 1100 x 760 mm.	4664

21.7 Special Accessories

Article	Description	Art. No.
MACHINE ACCESS CONTROL TM 100	User database and TM 100 Key system for reliable and secure machine access control with a total of 1 key tag (red) for administrator access and four user keys (blue) for authorised persons who are allowed to work on the machine.	4655
PERSONALISED USER KEY	Blue, for user database TM 100 (content 10 pieces).	4670
MASTER KEY	Red, for user database TM 100 (content 1 piece).	4671
CENTRAL LUBRICATION	For supplying grease to all lubrication points of the machine via hand pump, with 400 g grease cartridge, output pressure max. 350 bar.	4858
SPECIAL VOLTAGE 220 V/50 HZ, MAX. 7.5 KW	Instead of the standard 400 V voltage.	4601

You can find more spare parts in the online shop on <https://www.hokubema.com>.

22 Disassembly and Scrapping

When dismantling and scrapping the machine, the current EU regulations or the respective regulations and laws of the country of operation, which are prescribed for proper dismantling and disposal, must be observed. The aim is to dismantle the machine and its various materials and components properly, to recycle all possible parts and to dispose of non-recyclable components in the most environmentally friendly way.

	<p>Please pay particular attention to</p> <ul style="list-style-type: none"> • <i>the dismantling of the machine in the working area</i> • <i>proper dismantling of the machine and accessories</i> • <i>a safe and proper removal of the machine</i> • <i>proper separation of all components and materials.</i>
---	--

When dismantling and disposing the machine, the laws and regulations in force at the place of use concerning health and environmental protection must be observed.

	<p>Remove all residues of oil, grease and other lubricants and have them disposed of properly by a qualified disposal company.</p>
---	---

When separating, disposing of or recycling the machine materials, comply with the environmental protection laws in force at the place of use regarding the disposal of industrial solid waste toxic and hazardous waste.

	<ul style="list-style-type: none"> • <i>Hoses and plastic parts as well as other components that are not made of metal must be dismantled and recycled or disposed of separately.</i> • <i>Electrical components such as cables, switches, connectors, transformers, etc. must be removed and (if possible) recycled or otherwise disposed of in a qualified manner.</i> • <i>Pneumatic and hydraulic parts such as valves, solenoid valves, pressure regulators, etc. must be removed and (if possible) recycled or otherwise disposed of in a qualified manner.</i> • <i>Dismantle the base frame and all metal parts of the machine and sort them according to material type. Metals can be melted down and recycled.</i>
--	--

In the event of improper disposal of lubricants, the following residual risks to the environment and health exist:

	<p>Pollution of the environment by seepage into groundwater or sewage system.</p>
---	--

	<p>Poisoning of the personnel contracted for the disposal.</p>
---	---

Note: The disposal of lubricants considered toxic and hazardous must be carried out in accordance with the regulations and laws in force at the respective place of use. Only qualified disposal companies that have the appropriate permits for the disposal of used oil and lubricants are to be commissioned with the disposal.

EU - Declaration of Conformity

in accordance with the EU Machinery Directive 2006/42/EC Annex II A

The manufacturer,

HOKUBEMA Maschinenbau GmbH

Graf-Stauffenberg-Kaserne

Binger Str. 28 | Halle 120

DE 72488 Sigmaringen (Germany)

Phone: +49 (0) 7571 / 755 - 0

Fax: +49 (0) 7571 / 755 - 222

hereby declares that the manufactured machine

Tilting Spindle Moulder TYPE 245 | 10

Machine-No.:

Year of manufacture:

in the version provided complies with the following directives:

- Machinery Directive 2006/42/EG
- EMC Directive 2014/30/EG

Applied guidelines in particular:

- DIN EN 848-1

The notified body (0392)

Fachausschuss HOLZ

- Prüf- und Zertifizierungsstelle im BG- PrüfZert -

Vollmoellerstraße 11

DE 70563 Stuttgart (Germany)

has carried out an EC type-examination for the above machine.

Mr. Andreas Ganter, Graf-Stauffenberg-Kaserne, Binger Str. 28 | Halle 120,
72488 Sigmaringen (Germany), is authorised to compile the technical documentation.

Type Examination Certificate No.: 111007 dated 28.01.2011

Sigmaringen, 01.04.2022

.....



.....

Reinhold Beck
Managing Director