

TRANSLATION OF THE ORIGINAL VERSION

PANHANS

QUALITÄT SEIT 1918

CE

Operating Manual

Surface Planers and Jointers

PANHANS Types 334|20, 335|20 and 336|20



Machine Types:

334|20

335|20

336|20

HOKUBEMA Maschinenbau GmbH

Graf-Stauffenberg-Kaserne, Binger Str. 28 | Halle 120

DE 72488 Sigmaringen | Tel. +49 07571 755-0

E-Mail: info@hokubema-panhans.de | Web: <https://hokubema-panhans.de>

Space for notes:

HOKUBEMA Maschinenbau GmbH

 Graf-Stauffenberg-Kaserne
 Binger Straße 28 | Halle 120
 DE 72488 Sigmaringen
 Tel.: +49 (0)7571-755-0
 Fax: +49 (0)7571-755-222

<h2>Handover Certificate</h2>		
Machine type:		
Machine no.:		
Construction year:		
Customer address (location of the machine):		
Name:		
Street:		
Postcode/City:		
Phone:	Fax:	
E-mail:		
<p>Warranty: On the basis of our Terms and Conditions of Sale, Delivery and Payment of the respective current status, we assume a warranty of 12 months, calculated from the day of delivery, for material defects and defects of title in connection with the delivery for the above-mentioned machine.</p>		
<p>Warranty claims: Warranty claims on the part of HOKUBEMA Maschinenbau GmbH only exist if we have received the signed handover certificate and the machine has been properly commissioned. We therefore ask for immediate return.</p> <p>Important: Please read and follow the instructions in chapter ⇒ 1 "<u>Liability and Warranty</u>".</p>		
<p>Confirmation of the buyer:</p> <ul style="list-style-type: none"> ✓ The machine described above was purchased by me/us. ✓ Together with this handover certificate, I have received the operating manual valid for the machine (edition: _____). ✓ The operating instructions have been read and understood by me, as well as by all persons responsible for operating the specified machine. I will ensure that persons working on the machine at a later date are also instructed accordingly. 		
_____ Name and position	_____ Date	_____ Signature of the customer
Address of the dealer (company stamp):	The machine, including the operating manual, was handed over to the buyer and installed according to the specifications in the operating manual.	
	_____ Date	_____ Signature - Customer Service

Space for notes:

HOKUBEMA Maschinenbau GmbH

 Graf-Stauffenberg-Kaserne
 Binger Straße 28 | Halle 120
 DE 72488 Sigmaringen
 Tel.: +49 (0)7571-755-0
 Fax: +49 (0)7571-755-222

<h2>Handover Certificate</h2>	
Machine type:	
Machine no.:	
Construction year:	
Customer address (location of the machine):	
Name:	
Street:	
Postcode/City:	
Phone:	Fax:
E-mail:	
<p>Warranty: On the basis of our Terms and Conditions of Sale, Delivery and Payment of the respective current status, we assume a warranty of 12 months, calculated from the day of delivery, for material defects and defects of title in connection with the delivery for the above-mentioned machine.</p>	
<p>Warranty claims: Warranty claims on the part of HOKUBEMA Maschinenbau GmbH only exist if we have received the signed handover certificate and the machine has been properly commissioned. We therefore ask for immediate return.</p> <p>Important: Please read and follow the instructions in chapter ⇒ 1 "Liability and Warranty".</p>	
<p>Confirmation of the buyer:</p> <ul style="list-style-type: none"> ✓ The machine described above was purchased by me/us. ✓ Together with this handover certificate, I have received the operating manual valid for the machine (edition: _____). ✓ The operating instructions have been read and understood by me, as well as by all persons responsible for operating the specified machine. I will ensure that persons working on the machine at a later date are also instructed accordingly. 	
_____	_____
Name and position	Date

Signature of the customer	
<p>Address of the dealer (company stamp):</p>	<p>The machine, including the operating manual, was handed over to the buyer and installed according to the specifications in the operating manual.</p>

	Date

	Signature - Customer Service

Table of Contents

1	Liability and Warranty	10
2	Introduction	11
2.1	Legal Notice	11
2.2	Illustrations	11
3	Symbols	11
3.1	General Symbols	11
3.2	Symbols in Safety Instructions	12
4	General	13
4.1	Target Group and Previous Experience	13
4.2	Requirements for the Operators	13
4.3	Accident Prevention	13
4.4	General Safety Regulations	14
4.5	Structure and Function	15
4.6	Advantages & Special Features of the Machine	15
4.7	Standard Equipment	16
4.8	Available Options	16
5	Safety	17
5.1	Basic Safety Instructions	17
5.1.1	Application Area and Intended Use	17
5.1.2	Modifications and Conversions to the Machine	17
5.1.3	Residual Risks	18
5.2	Observe the Environmental Protection Regulations	19
5.2.1	Organisational Measures	19
5.2.2	Personnel Selection and Qualification - Basic Duties	19
5.3	Safety Instructions for Specific Phases of Operation	20
5.3.1	Normal Operation	20
5.3.2	Special work within the Scope of Maintenance Work as well as Troubleshooting in the Workflow	21
5.3.3	Safe Working Practices	21
5.4	Hazardous Areas	22
5.4.1	Working Areas & Protective Measures	22
6	Machine Data	23
6.1	Technical Specifications	23
6.2	Technical Features	23
6.3	Emission Levels	24
6.3.1	Noise Information	24
6.3.2	Noise Emission Values	24
7	Dimensions	25
7.1	Front & Top View	25

7.2	Side View	26
8	Installation and Connection	27
8.1	Check Delivery Conditions	27
8.2	Transport	27
8.3	Installing the Machine	27
8.4	Temporary Storage	28
8.5	Lashing on a Transport Vehicle	28
8.6	Connecting the Extraction Unit	29
8.7	Electrical Connections	30
8.8	Backup Fuse	30
8.9	Supply Cable	30
8.10	Machine Socket (Option)	30
8.11	Attachment of Auxiliary Equipment	30
9	Components and Controls	31
9.1	Machine Components	31
9.2	Control Panel "Surface Planing & Jointing" (Details)	32
10	Commissioning	33
10.1	Switching the Machine ON and OFF	33
10.1.1	Switching ON	33
10.1.2	Switching OFF	33
11	Machine Operation	34
11.1	Electrical Chip Removal Adjustment	34
11.2	Hollow and Pointed Joint Adjustment	34
11.2.1	Calibrate Hollow and Pointed Joint on the Digital Indicator	34
11.3	Adjusting the Outfeed Table	35
11.4	Operating the Fence	36
11.4.1	Linear Adjustment	36
11.4.2	Angular Adjustment up to 35°	36
11.4.3	Angular Adjustment > 35°	37
11.4.4	Maintenance of the fence	37
11.4.5	Using the Auxiliary Fence	37
11.4.6	Push Block & Push Handle	37
11.5	Planer Guard TXF 1570	38
11.5.1	Flat Planing	38
11.5.2	Edge Jointing	38
11.6	Optional Planer Guards SUVAMATIC & TX MATIC	38
12	Calibrating the Digital Indicator	39
12.1	Calibrate Chip Removal	39
12.2	Calibrating Angles for Hollow and Pointed Joints	40
13	Changing the Planer Knives	41

13.1	Changing the TERSA Knives on an All-Steel Cutter Block (standard)	41
13.2	Changing the Knives on PANHANS Traditional Cutter Block (Option)	42
13.2.1	PANHANS Cutter Block Adjusting Devices	42
13.2.2	Magnetic Quick Adjusters 1533 (Option)	43
13.3	Changing the Knives on PANHANS Spiral Cutter Block (Option)	44
13.3.1	Procedure for Changing the Knives	44
13.3.2	Advantages of the PANHANS Spiral Cutter Block	44
14	Troubleshooting	45
15	Maintenance and Inspection	46
15.1	Lubrication Instructions	46
15.2	Readjust Motor Brake	47
15.2.1	Checking the Adjustment	47
15.2.2	Replace Motor Brake	47
15.3	Tighten / Replace the V-Belt	48
15.4	Adjust the workpiece fence	49
16	Options and Accessories	50
16.1	Cutter Blocks and Planing Knives	50
16.1.1	Accessories for Tersa Cutter Blocks (Standard)	50
16.1.2	Accessories for Traditional Cutter Block (Option)	50
16.1.3	Accessories for Spiral Cutter Block (Option)	51
16.2	Planer Guards	51
16.3	Special Accessories	51
17	Disassembly and Scrapping	52
	EU - Declaration of Conformity	53

List of Figures

Figure 1: Surface planer & jointer 335 20.....	11
Figure 2: Danger zones.....	22
Figure 3: Nameplate.....	23
Figure 4: Working area.....	24
Figure 5: Dimensions top & side view.....	25
Figure 6: Dimensions side view.....	26
Figure 7: Transportation.....	27
Figure 8: Adjustable underlay.....	27
Figure 9: Lashing points.....	28
Figure 10: Connection to an extraction unit.....	29
Figure 11: Electrical connection.....	30
Figure 12: Console for auxiliary equipment.....	30
Figure 13: Components & controls (front view).....	31
Figure 14: Control panel "surface planing & jointing".....	32
Figure 15: Control panel with main switch.....	33
Figure 16: Chip removal.....	34
Figure 17: Hollow / pointed joint adjustment.....	34
Figure 18: Outfeed table handwheel.....	35
Figure 19: Clamping lever for fence.....	36
Figure 20: Linear adjustment of the fence.....	36
Figure 21: Activate angular adjustment.....	36
Figure 22: Adjusting angles.....	36
Figure 23: Auxiliary fence.....	37
Figure 24: Push block & push handle.....	37
Figure 25: Planer guard TXF 1570.....	38
Figure 26: Guard setting for flat planing.....	38
Figure 27: Guard setting for edge jointing.....	38
Figure 28: Type SUVAMATIC (example).....	38
Figure 29: Calibrate chip removal 1.....	39
Figure 30: Calibrate chip removal 2.....	39
Figure 31: Calibrate chip removal 3.....	39
Figure 32: Calibrate chip removal 4.....	39
Figure 33: Calibrate angle 1.....	40
Figure 34: Calibrate angle 2.....	40
Figure 35: Calibrate angle 3.....	40
Figure 36: Calibrate angle 4.....	40
Figure 37: Changing Tersa knives.....	41
Figure 38: Traditional cutter block.....	42
Figure 39: Standard adjusting devices.....	42
Figure 40: Magnetic quick adjusters 1533.....	43
Figure 41: Adjustment of the cutter block.....	43
Figure 42: : Spiral cutter carbide inserts.....	44
Figure 43: Readjust motor brake.....	47
Figure 44: Tighten the V-belt.....	48
Figure 45: Lock-in rail.....	49
Figure 46: Remove nut + spring.....	49
Figure 47: Check mechanics.....	49
Figure 48: Adjust stop bolts.....	49
Figure 49: Check adjustment.....	49
Figure 50: Tension Bowden cable.....	49
Figure 51: Check tension.....	49

Revisions:

Revision	Editor	Modification	Date
001	AG	Original manual translated	14.02.2022
002	AG	New sections 10.4.4 and 14.4 added.	31.01.2023

1 Liability and Warranty

When purchasing a machine or additional component (hereinafter referred to as “machine”), the General Terms and Conditions of Sale and Delivery of HOKUBEMA Maschinenbau GmbH generally apply. These are provided to the purchaser or operator at the latest when the contract is concluded.



IMPORTANT NOTE: Liability and warranty claims shall only commence from the point in time at which the signed handover certificate (see ⇒ page 3 resp. 5) from the dealer and/or end customer for the delivered machine has been submitted to HOKUBEMA Maschinenbau GmbH in written form.

Liability and warranty claims for personal injury and property damage are generally excluded if they are due to one or more of the following causes:

- Commissioning of the machine without prior machine instruction by an authorised and adequately trained specialist who is familiar with the function and dangers of the machine.
- Electrical connection as well as repair and/or maintenance work on electrical components by personnel who do not have the appropriate qualifications.
- Connection and repair and/or maintenance work on hydraulic or pneumatic components by personnel who do not have the appropriate qualifications.
- Non-observance of the instructions in the operating manual, in particular the chapter “Safety”.
- Improper use or operation in an unauthorised area of application.
- Improper assembly, commissioning, operation and maintenance of the machine.
- Unauthorised conversions or modifications to the machine or additional components.
- Operating the machine without using all the protective equipment available for the operation.
- Inadequate monitoring and maintenance of the machine components and protective devices.
- Continuing to operate the machine when faults, damage or defects are present.
- Processing materials that do not correspond to the machine's area of application.
- Carrying out operations that are not permitted for the machine supplied.
- Use of tools that are not permitted for the machine supplied.
- Operating the machine outdoors or in damp, wet or potentially explosive environments.
- Operation of the machine outside permissible ambient temperatures or humidity.
- Grossly negligent behaviour when handling or operating the machine.
- Impact by foreign bodies, e.g. stones, metal parts, etc.
- Improperly carried out repairs.
- Catastrophic events due to force majeure.

2 Introduction

The purpose of this operating manual is to acquaint the user with the machine and enable him to use it to the full extent of its intended capabilities. Additionally it contains important information to operate the machine safely, properly and economically.

Observance of the manual helps to avoid hazards, reduce repair costs and downtimes and increase the reliability and service life of the machine.

Furthermore, this operating manual serves to supplement instructions based on national regulations for accident prevention and environmental protection.



Figure 1: Surface planer & jointer 335/20

	<p><i>This operating manual must always be available at the place of use of the machine. It must be read and followed by every person who is assigned to work on the machine, e.g.</i></p> <ul style="list-style-type: none"> • <i>during operation, including set-up, troubleshooting in the work process, removal of production waste and maintenance,</i> • <i>during maintenance (servicing, inspection, repair)</i> • <i>and/or during transport.</i>
--	--

Apart from the operating manual and the legally binding accident prevention provisions applicable in the country and place of use, the recognized technical regulations for safe and proper work must also be observed.

2.1 Legal Notice

All contents of these operating instructions are subject to the rights of use and copyright of Hokubema Maschinenbau GmbH. Any reproduction, modification, further use and publication in other electronic or printed media, as well as their online publication, requires the prior written consent of Hokubema Maschinenbau GmbH.

2.2 Illustrations







All photos, figures and graphics contained in this document are for illustration and better understanding only and may differ from the current state of the product.

3 Symbols

3.1 General Symbols

Symbol	Meaning
	Indicates passages within this operating manual that must be particularly observed in order to prevent malfunctions or damage to the machine.
	Refers to chapters, sections, or figures within this document.
	Refers to an external document or a third-party source.

3.2 Symbols in Safety Instructions

Symbol	Safety Instruction
	General danger symbol, which requires the highest attention! <i>Failure to observe may result in damage to the equipment, serious injury or even death.</i>
	Warning of possible danger from forklift traffic! <i>Non-observance may result in life-threatening injuries.</i>
	Warning indicates a possible hazard under suspended loads! <i>Non-observance may result in life-threatening injuries.</i>
	Warning indicates a possible fall hazard! <i>Non-observance of these instructions may result in serious injuries.</i>
	Warning indicates a possible cutting hazard! <i>Risk of personal injury and possibly additional damage to equipment.</i>
	Reference to the obligation to wear protective gloves! <i>Non-observance of these instructions may result in personal injury.</i>
	Reference to the obligation to wear hearing protection! <i>Non-observance of these instructions may result in personal injury.</i>
	Reference to the obligation to wear protective goggles! <i>Non-observance of these instructions may result in personal injury.</i>
	Reference to the obligation to wear a respiratory protection mask! <i>Non-observance of these instructions may cause breathing difficulties and lung damage.</i>
	Possible dangerous crushing hazard in the area of stationary objects! <i>Risk of personal injury and possibly additional equipment damage.</i>
	Reference to a possible crushing hazard! <i>Non-observance increases the risk of injury to hands and fingers!</i>
	This symbol warns of the dangers of electric voltage! <i>Failure to observe may result in damage to the equipment, serious injury or even death.</i>
	Fire hazard! Do not smoke and do not ignite open fire.
	Access for unauthorized persons prohibited! <i>Risk of personal injury and possibly additional equipment damage.</i>
	This safety notice indicates a possible dangerous pull-in hazard! Wearing loose clothing, jewellery as well as long untied hair is prohibited! <i>Risk of personal injury and possibly additional damage to property.</i>

4 General

The surface planers and jointers of the types 334|20, 335|20 and 336|20 were produced by HOKUBEMA Maschinenbau GmbH according to the current state of the art and put into operation as a complete machine. All legal and normative regulations were complied with.

- The three machine variants differ in their respective planing width:
Type 334|20 (410 mm) / Type 335|20 (510 mm) / Type 336|20 (630 mm)
- The infeed table is equipped with an electromotive chip removal adjustment up to max. 8 mm.
- The outfeed table is equipped with a hollow and pointed joint adjustment.
- All measuring scales are manufactured according to accuracy class 2 in accordance with the calibration regulations.

4.1 Target Group and Previous Experience

This operating manual is intended for the operating and maintenance personnel of the machine. The operating personnel is to be determined by the operator and must further meet the following requirements:

- Basic technical knowledge (e.g. apprenticeship as carpenter, machine fitter, etc. and/or practice in operating woodworking machines)
- Reading and understanding these operating and maintenance instructions

In order to acquire the knowledge required to operate this machine, the operator must ensure the following measures:

- Product training for every operator (also possible external personnel)
- Regular safety instruction

4.2 Requirements for the Operators

- The surface planer & jointer may only be operated by trained personnel who have also read this manual.
- Inspection, maintenance, cleaning and repair may only be performed by technical specialists with product-specific training and mechanical and/or electrical training.
- Specialists with product-specific training are to be commissioned and held responsible for planning and checking the work.
- The national protective regulations for employees must be observed.
- The operator is responsible for the safe use of the machine.
- The legal minimum age must be observed.

4.3 Accident Prevention

To avoid accidents, the following rules must be observed for operation:

- Prevent unauthorized persons from gaining access to the machine.
- Keep unauthorized persons away from the danger areas.
- Repeatedly inform present other persons about existing residual risks (see section ⇒ 5.1.3 "Residual Risks").
- Conduct and record regular training & instruction for persons who must be in the area of the machine.
- New employees must be trained internally to work on a thickener and this training must be documented.

4.4 General Safety Regulations

In general, the following safety regulations and obligations apply when handling the planer & thicknesser:

- A surface planer & jointer may only be operated in a technically perfect and clean condition.
- It is prohibited to remove, modify or bypass any protective, safety or monitoring equipment.
- It is forbidden to modify or alter the machine without the written approval of the manufacturer / supplier.
- Faults or damage must be reported to the operator immediately, eliminated without delay and repaired if necessary.
- For repairs, only original spare parts may be used.
- All protective, safety and monitoring devices must be regularly checked and maintained by the operator.
- Only instructed, trained or qualified persons may work on this machine.
- Maintenance work must be carried out and documented in accordance with the maintenance instructions.
- After maintenance or repair, the machine may only be started with all protective devices fitted. A responsible person must be defined for this purpose, who checks that the guards have been properly installed.

For the operation of a thickness planer, the respective national safety regulations for employees as well as the national safety and accident prevention regulations apply.

4.5 Structure and Function

- The machine has a heavy, well-shaped construction and meets all the requirements of modern wood processing.
- The base gives the machine a perfect stand and smooth running. The smooth front, as well as the stand retracted at the bottom, allow trouble-free work.
- The tables are heavily ribbed for secure support, and the long version features asymmetrical table lengths and serrated table lips. The outfeed table is equipped with hollow and pointed joint adjustment. The height of the infeed table is adjusted by an electric motor to set the chip removal thickness. The chip removal and the setting of the hollow and pointed joint are visualized on a digital indicator.
- The fence has a smooth-running roller guide with an additional support roller on the outfeed table. It can be quickly adjusted over the entire table width with a practical one-handed lever. This also allows the fence to be tilted from 0° to 45°.
- The Tera cutter block installed in the standard model is a dynamically balanced safety four-knife shaft running in special ball bearings. Other types of cutter blocks are optionally available (see section ⇒ 16.1).
- The suction nozzle has a diameter of 160 mm and is fixed in the machine.
- The machine is driven by a three-phase motor with mechanical motor brake. It has a central circuit with push-switch unit and motor protection switch.
- The control panel (with main switch, cutter block switch, brake release switch, height adjustment of the feed table and digital indicator) is designed to be user-friendly, as it is easily accessible from the operating side and placed at eye level.
- The guards comply with the regulations of the German Employer's Liability Insurance Association for Wood.

4.6 Advantages & Special Features of the Machine

The surface planers and jointers of types 334|20 (410 mm planing width), 335|20 (510 mm planing width) and 336|20 (630 mm planing width) are characterized, in addition to their compact and robust steel construction, by the extremely smooth and quiet running of their dynamically balanced cutter block.

The maintenance-free design of the bearing arrangement with high-performance precision ball bearings guarantees long-lasting reliability.

The finely planed cast iron tables with a total length of 2850 mm are mounted vibration-free and ensure a perfect planing result. The controls for the electromotive height adjustment with digital indicator for the chip removal setting are functionally arranged.

The machine is suitable for surface planing and jointing, including hollow and pointed joint adjustment at the outfeed table. The hollow and pointed joint can be precisely adjusted by a handwheel.

Surface planing is possible up to a chip removal of 8 mm.

The working position is ergonomic directly on the cutter block.

The fence, made of a thick-walled, anodized double-chamber profile, can be adjusted smoothly and is infinitely variable up to 45°. The integrated auxiliary fence can be folded up and down easily and without tools for immediate use.

4.7 Standard Equipment

- Powerful three-phase motor 5.5 kW (7.5 HP)
- Planer guard TXF 1570 with fold-down cover
- Electromotive adjustment of the infeed table via push-button operation
- Finely planed machine tables (total table length 2850 mm)
- All-steel cutter block with TERSA knives
- Pushbutton for starting the cutter block
- Anodized fence ruler
- Digital indicator for chip removal
- Additional swivelling auxiliary fence
- Angle console for mounting a feed unit
- Serrated table lips for noise reduction
- Automatic star-delta starting and motor protection switch
- 1 grease gun (hollow mouthpiece)
- 2 suction nozzles 160 mm Ø
- 1 Si-Tec push block for safe dressing of short workpieces
- Hand push handle for self-made push blocks
- Brass wedge for Tersa cutter change
- CE conform and GS tested

4.8 Available Options

- PANHANS 4-knives traditional cutter block with brass adjusters as well as necessary tools (see section ⇒ 16.1)
- All-steel spiral cutter block consisting of 6 spiral-shaped blade rows with improved cutting quality due to "pulling" cut, incl. 10 spare knives, mounting material and tools (see section ⇒ 16.1)
- Planing guard SUVAMATIC (see section ⇒ 11.6)
- Planing guard TX MATIC (see section ⇒ 11.6)

Further accessories, options and spare parts can be found in chapter ⇒ 16.

5 Safety

5.1 Basic Safety Instructions

Woodworking machines can be dangerous if used improperly. Therefore, observe the safety instructions listed in this chapter and the accident prevention regulations of your employer's liability insurance association!

	<i>The manufacturer accepts no liability for damage and malfunctions resulting from failure to observe these operating instructions.</i>
---	---

5.1.1 Application Area and Intended Use

	<p><i>The machine is used exclusively for surface planing and jointing of solid wood (soft and hard woods) as well as plastics and wood-containing board materials.</i></p> <p><i>This machine is not suitable for processing metal or scrap wood - which could contain nails, screws and other metal parts.</i></p> <p><i>The machine may only be operated on a firm, level surface with a minimum load-bearing capacity of 1,000 kg/m².</i></p>
---	---

Any processing of other materials requires prior consultation with and approval of the manufacturer.

	<i>Improper use can lead to danger to persons and to a defect or damage to the machine.</i>
--	--

	<i>Only the manufacturer's original planing cutter-blocks and replacement knives according to EN 847-1 are permitted as tools. These must be marked with MAN!</i>
---	--

<i>Processing type</i>	<i>Length</i>	<i>Height</i>	<i>Width</i>
Surface planing	5500 mm	75 mm	410 / 510 / 630 mm
Jointing	5500 mm	1000 mm	100 mm

The machine is not suitable for operation outdoors or in potentially explosive areas.

- Permissible ambient temperature: +5 ... +40° C.
- Permissible humidity: 30 ... 90 %.

Intended use also includes the connection of the machine to an adequately dimensioned extraction system and compliance with the operating, maintenance and servicing conditions specified in the operating manual.























Any other use is not in accordance with the intended use and is therefore prohibited.

5.1.2 Modifications and Conversions to the Machine

	<i>Unauthorized conversions and modifications to the machine are strictly prohibited for safety reasons. This will invalidate the CE declaration of conformity! The manufacturer is not liable for any resulting damage. The risk for this is borne exclusively by the operator/user.</i>
---	--

5.1.3 Residual Risks

The machine is built according to the latest state of the art and the recognised safety rules. Nevertheless, the use of the machine may cause danger to life and limb of the user or third parties or damage to the machine and other equipment. Due to the construction of the machine, the following residual risks can occur even when used as intended and despite compliance with all relevant safety regulations:

	Reading and applying the operating manual is mandatory for the operating personnel.
	Be alert to possible crushing hazards: a) when transporting the machine by forklift truck → between forks & pallet / machine b) when picking up the machine → between machine / pallet and floor c) when lowering the machine → between machine and fixed equipment
	Be alert to possible crushing hazards when lowering the machine (from the cargo pallet to the floor) with a forklift truck or overhead crane.
	Make sure that no objects fall from the forklift truck / crane. Do not leave any objects / tools on the machine.
	It is strictly prohibited to ride on the machine during a lifting operation (with the indoor crane or forklift). There is a danger of falling!
	Unauthorised persons are not allowed to enter the installation area of the machine (responsibility of the operator).
	Be aware of possible tripping and slipping hazards on the floor. Prevent possible hazards by keeping the floor dry and clean and by using anti-slip floor coverings around the machine.
	Be aware of the danger from falling objects such as workpieces, tools or similar. Therefore, wear safety shoes, especially when transporting and setting down the machine.
	Pay attention to the existing danger of cuts on the planing knives. Never reach into the running band saw blade! Wear protective gloves when changing the planing knives.
	Be aware of the danger of cuts due to chips and splinters and never remove them from the danger area by hand.
	Be aware of a possible danger of being drawn in by moving machine parts or tools. This can cause pieces of clothing or hair to be caught. Always wear tight-fitting clothing and a hair net if necessary. Generally avoid jewellery, loose clothing and untied long hair.
	Danger from electric shock! There are hazards when working on the electrical system. This work must only be carried out by qualified personnel!
	Danger from electric shock! It is strictly forbidden to bypass safety devices (e.g. safety switches).
	Electrical equipment must be maintained and cleaned regularly.
	Pay attention to the danger of crushing on workpiece guides and moving machine parts.
	Make sure that no unauthorised persons are in the area of the machine.
	Be aware of the risk of injury from flying tool parts in the event of tool breakage. Therefore wear protective goggles.
	Be aware of the risk of injury from flying workpiece parts and chips, splinters and dust coming out of the machine. Therefore wear protective goggles.
	Be aware of the increased noise emission and wear hearing protection.
	Be aware of the increased dust generation. Use the extraction device and wear a dust mask if necessary.
	The emergency stop button must always be freely accessible. Check the function of the emergency stop buttons daily before starting work.
	Fire hazard due to wood dust in connection with flying sparks and/or open fire!

5.2 Observe the Environmental Protection Regulations

During all work with the machine, the environmental protection regulations, obligations and laws for waste avoidance and proper recycling and/or disposal applicable at the place of use must be observed. This applies in particular to installation, repair and maintenance work involving substances that could pollute the groundwater (e.g. hydraulic oils and cleaning agents and liquids containing solvents). In any case, prevent them from seeping into the ground or entering the sewage system.

	<p>Store and transport the above-mentioned hazardous substances only in suitable containers. Avoid leakage of hazardous substances by using suitable collection containers. Ensure that the above-mentioned substances are disposed of by a qualified disposal company.</p>
---	--



5.2.1 Organisational Measures

- ⚠ Always keep this operating manual within easy reach and at the place of use of the machine.
- ⚠ In addition to the operating manual, observe and instruct on generally applicable legal and other binding regulations for accident prevention and environmental protection.
- ⚠ Supplement the operating manual with further instructions, including supervisory and reporting duties, to take account of special operational features (e.g. with regard to work organisation, work processes, personnel employed).
- ⚠ Before starting work on the machine, the person responsible for its operation must have read the operating instructions, especially the chapter ⇒ 5 "Safety Instructions". This applies in particular to personnel who only occasionally work on the machine.
- ⚠ Check that work is carried out in a safety-conscious and hazard-conscious manner and in compliance with the operating manual.
- ⚠ Operators must not wear open long hair, loose clothing or jewellery (including rings). There is a risk of injury, e.g. by getting caught or drawn in.
- ⚠ Observe the safety instructions and danger warnings on the machine and keep them complete and in legible condition.
- ⚠ In case of safety-relevant changes to the machine or its operating behaviour, shut down the entire system immediately and report the fault to the responsible office/person.
- ⚠ Use personal protective equipment as necessary or required by regulations.
- ⚠ Do not make any modifications, additional attachments or conversions to the machine without the manufacturer's approval! This will compromise safety and invalidate the manufacturer's warranty and any liability claim.
- ⚠ Spare parts must meet the technical requirements specified by the manufacturer. The exclusive use of original spare parts ensures this. Therefore, only use original spare parts from the manufacturer.
- ⚠ Observe the fire alarm and firefighting possibilities. Make the location and operation of fire extinguishers (fire class ABC) known. Do not use water!

5.2.2 Personnel Selection and Qualification - Basic Duties

- ⚠ The machine design and operation is intended for right-handers.
- ⚠ Work on and with the machine may only be carried out by reliable personnel. Observe the legal minimum age!
- ⚠ Only use trained or instructed personnel. Clearly define the responsibilities of the personnel for operating, setting up, maintaining and repairing!
- ⚠ Ensure that only authorised personnel work on the machine!
- ⚠ If personnel to be trained or apprenticed have to work on the machine, this may only be done under the constant supervision of an experienced resp. qualified person.
- ⚠ Work on the electrical equipment of the machine may only be carried out by a qualified electrician or by untrained persons under the direction and supervision of a qualified electrician in accordance with the electrotechnical regulations.



5.3 Safety Instructions for Specific Phases of Operation

	<i>Defects and damage to the machine are to be reported immediately after detection.</i>
	<i>Any mode of operation that compromises safety is prohibited!</i>
	<i>Sufficient lighting around the machine must be ensured!</i>

5.3.1 Normal Operation

-  **Guards:** Take measures to ensure that the machine can only be operated in a safe and functional condition. Only operate the machine when all guards and safety-related devices such as









 - detachable guards (e. g. TXF 1570, TX MATIC or SUVAMATIC),
 - emergency stop units,
 - noise insulations,
 - extraction system,
 - separating protective devices

are available and functional.
-  **Knife change:** Change and adjust the knives as described in chapter ⇨ 13. The fence must always be securely fastened when changing the knives.
-  **Workpiece:** Before the operation, check the workpiece for

 - foreign inclusions
 - knots
 - twists (contortions)

and other irregularities.

Workpieces that are longer than the infeed or outfeed table must be additionally supported (e.g. with support rollers or similar).

Due to the automatic feed, make sure that there is sufficient space on the removal side in front of stationary obstacles (danger of crushing!).
-  **Auxiliary equipment:** For surface planing and jointing of short workpieces that do not allow a safe hand support, push blocks are to be used. The shape of the push block must be adapted to the workpiece.
-  **Machine condition:** Check the machine for externally visible damage and defects at least once per shift! Any changes that have occurred (including those in the operating behaviour) must be reported immediately to the responsible office or person! If necessary, stop and secure the machine immediately!
-  **Extraction:** The machine must be connected to an effective extraction system. This requires a mean flow velocity of 20 m/s.
-  **Working area:** An obstacle-free working area around the machine is essential for safe operation. Ensure that there is sufficient space on the outfeed side. When using a feed unit, there is a risk of crushing from the workpiece. The floor should be level, well maintained and free of debris such as chips and cut workpieces.
-  **Planing area during operation:** Never try to remove offcuts, chips or other parts from the planing area while the machine is running! Never use your hands to remove!
-  **Workpiece inspection:** Inspect the workpiece for foreign inclusions, knots, twists and other irregularities.
-  **Lighting:** The working area should be sufficiently bright due to general or local lighting.
-  **Work interruptions:** Switch off the machine even during short interruptions! Never leave the machine running unattended!
-  **Leaving the machine:** Switch off the control voltage and main switch before leaving the machine. Never leave the machine unattended in an unsecured state.

5.3.2 Special work within the Scope of Maintenance Work as well as Troubleshooting in the Workflow

- ⚠ Observe maintenance and inspection activities prescribed in the operating manual!
- ⚠ These activities, as well as all other repair work, may only be carried out by qualified personnel!
- ⚠ For all work concerning operation, production adjustment, conversion or setting of the machine and its safety-related equipment as well as maintenance and repair, observe switch-on and switch-off procedures according to the operating manual and instructions for maintenance work!
- ⚠ Secure the machine against unexpected restarting during maintenance and repair work.
➔ **Lock the main switch with a padlock!**
- ⚠ Always tighten screw connections that have been loosened during maintenance and repair work!
- ⚠ If it is necessary to dismantle safety equipment during set-up, maintenance and repair, the safety equipment must be reassembled and checked immediately after completion of the maintenance and repair work!
- ⚠ Ensure safe and environmentally friendly disposal of operating and auxiliary materials (e.g. oils) and replacement parts (e.g. electronic components)!

5.3.3 Safe Working Practices

- ⚠ Always work with all protective devices! These must be in the intended places and in perfect working order. Defective guards must be replaced immediately.
- ⚠ Do not start planing until the motor / tool has reached full speed.
- ⚠ Do not use damaged tools resp. knives or cutting blocks.
- ⚠ Do not exceed the permissible speed of the tool.
- ⚠ Damaged parts must be replaced with new ones.
- ⚠ Workpieces that are longer than the infeed or outfeed table must be supported additionally. (e.g. table extension, support rollers or similar).
- ⚠ Repairs may only be carried out by qualified personnel and with the main switch locked.
- ⚠ Unused areas of the cutter block must always be covered (also during combined operation).
- ⚠ During surface planing workpieces with a length < 400 mm, thin workpieces or workpieces with a very smooth surface are to be pushed forward with a feed tray or sliding block.
- ⚠ When planing surfaces, always push the workpiece with the hand in a closed, flat position and the thumb resting against it. Advance the workpiece at a steady speed and with constant pressure on the table.
- ⚠ Do not remove splinters and chips by hand while the cutter is running.
- ⚠ When jointing high workpieces, ensure controlled lateral pressure (prevent tilting) and complete covering of the cutter block.
- ⚠ The machine is equipped with a mechanical brake. If this brake no longer brakes within the prescribed braking time (10 s) despite readjustment, the customer service must be informed.

5.4 Hazardous Areas

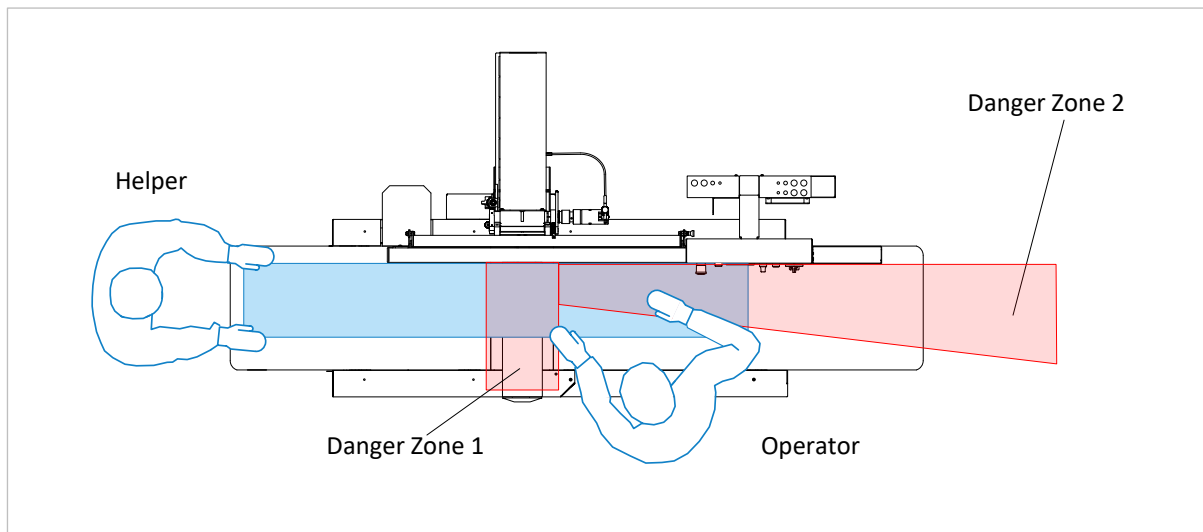



Figure 2: Danger zones

Danger Zone	Type of hazard	Prevention
<p>1</p> 	<p><i>Danger of drawing in and cutting!</i> The area around the cutter block is considered an absolute danger zone. There is an increased risk of injury and even death when reaching into this area. There is also an increased risk of clothing, hair, watches and jewellery being pulled in.</p>	<ol style="list-style-type: none"> 1. Never reach into the Danger Zone 1 when the cutter is running (see ⇨ Figure above). 2. Always cover the unused part of the cutter block with a planer guard. 3. To feed, the hands must lie flat on the workpiece with fingers closed and thumbs applied. Important: Do not grip the edges of the workpiece! 4. Wearing loose clothing, gloves, loose hair, watches and jewellery is prohibited. Suitable pushing aids must be used for short, very flat and narrow workpieces. 5. The operator must always stand in front of the planing & jointing table. It is forbidden to be in Danger Zone 2 (⇨ Figure above) when the cutter block is running. This applies equally to the operator and to any helper
<p>2</p> 	<p><i>Risk of kickback!</i> Risk of injury due to the workpiece being kicked back or due to workpieces and workpiece or tool parts being catapulted away (e.g. tool breakage).</p>	

5.4.1 Working Areas & Protective Measures

- When planing & jointing, the operator of the machine must generally stand in front of the planing table, to the right of the cutter block resp. planer guard. It is forbidden to enter the Danger Zone 2 marked in ⇨ Figure 2 while the cutter is running.
- A required helper for workpiece removal must generally stand on the left side of the planing & jointing table. The helper does not intervene in the machining process, but only removes the finished workpieces. It is forbidden for helpers to stay on the infeed side or in the danger zone.
- Any observers must generally remain outside the danger zones. A sufficient distance is prescribed so that the operator of the machine and any assistant cannot be hindered in their work.

6 Machine Data

6.1 Technical Specifications

Planing width:	max. 410 / 510 / 630 mm
Infeed table length:	1620 mm
Outfeed table length:	1170 mm
Total length:	2850 mm
Machine height:	approx.1600 mm
Chip removal:	max. 8 mm
Cutter block speed:	5000 rpm
Cutter block diameter:	125 mm
Cutter block brake:	Brake motor max. 10 braking cycles / h
Motor power:	5.5 kW / 7.5 HP
Motor voltage:	400 V / 50 Hz
Protection class:	IP54
Net weight:	870 / 1050 / 1400 kg
Dimensions:	see chapter ⇨ 7
Space requirement:	1600 x 3000 mm
Suction nozzle:	Ø 160 mm
Manufacturer:	
HOKUBEMA Maschinenbau GmbH Graf-Stauffenberg-Kaserne Binger Str. 28 Halle 120 DE-72488 Sigmaringen (Germany) Tel.: +49 (0) 7571 / 755-0 Fax: +49 (0) 7571 / 755-2 22	



HOKUBEMA
by

HOKUBEMA GmbH • D-72488 Sigmaringen
Telefon/phone +49(0)7571 755-0

Abrichthobelmaschine 

Baureihe line	
Typ type	
Maschinen-Nr. machine no.	
Baujahr year of construction	20
Bemessungsspannung U = nominal voltage U =	V
Frequenz/Phasenzahl frequency/phases	Hz / 3
Stromart kind of current	AC
Volllaststrom I = operating current I =	A
Überstromschutz, intern excess current protection, internal	A
	[]
	[]

Figure 3: Nameplate

6.2 Technical Features

- 2850 mm long machine table with finely planed surface and the typical features of the proven PANHANS surface planers and jointers.
- Suction nozzle Ø 160 mm for optimal suction during surface planing and jointing.
- Electric table height adjustment via keypad with LCD indication and an accuracy of 0.1 mm.
- Swivelling fence for quick and easy adjustment of different angles (0° - 45°).
- Integrated auxiliary fence for safe hand support on narrow workpieces.
- Electromotive adjustment of the feed table via pushbutton operation.
- TXF 1570 bridge guard with fold-away cover.

6.3 Emission Levels

6.3.1 Noise Information

The values given are emission levels and therefore do not necessarily represent safe workplace values. Although there is a correlation between emission and emission levels, it cannot be reliably deduced whether additional precautionary measures are necessary or not.

Factors that may affect the current emission level at the workplace include the duration of exposure, the nature of the workspace, other noise sources, etc., e.g. the number of machines and other activities in the vicinity. The permissible workplace values can also vary from country to country.

However, this information should enable the user to make a better assessment of hazard and risk.

6.3.2 Noise Emission Values

The specified measured values are determined in accordance with EN 860.

Uncertainty allowance K = 4 dB(A)

<i>Workplace-related emission value</i>		<i>Sound power level</i>	
Idle	93 dB(A)	Idle	Lwa = 84 dB(A)
Working	99 dB(A)	Working	Lwa = 92 dB(A)

	<i>The workplace-related noise emission values of the machine exceed 85 dB(A)! Therefore, suitable hearing protection must be provided to the personnel!</i>
---	---

<i>Workplace-related dust emission value</i> <i>(permissible 2.0 mg/m³ air)</i>
0.48 mg/m ³ air

Dust emission values:
Determined according to GS-HO-05

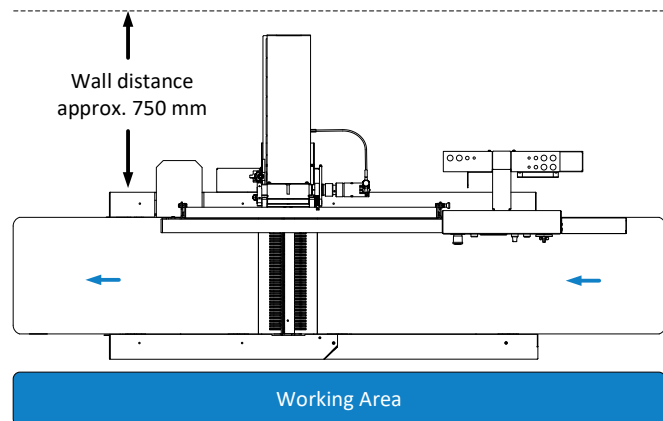

Figure 4: Working area

7 Dimensions

7.1 Front & Top View

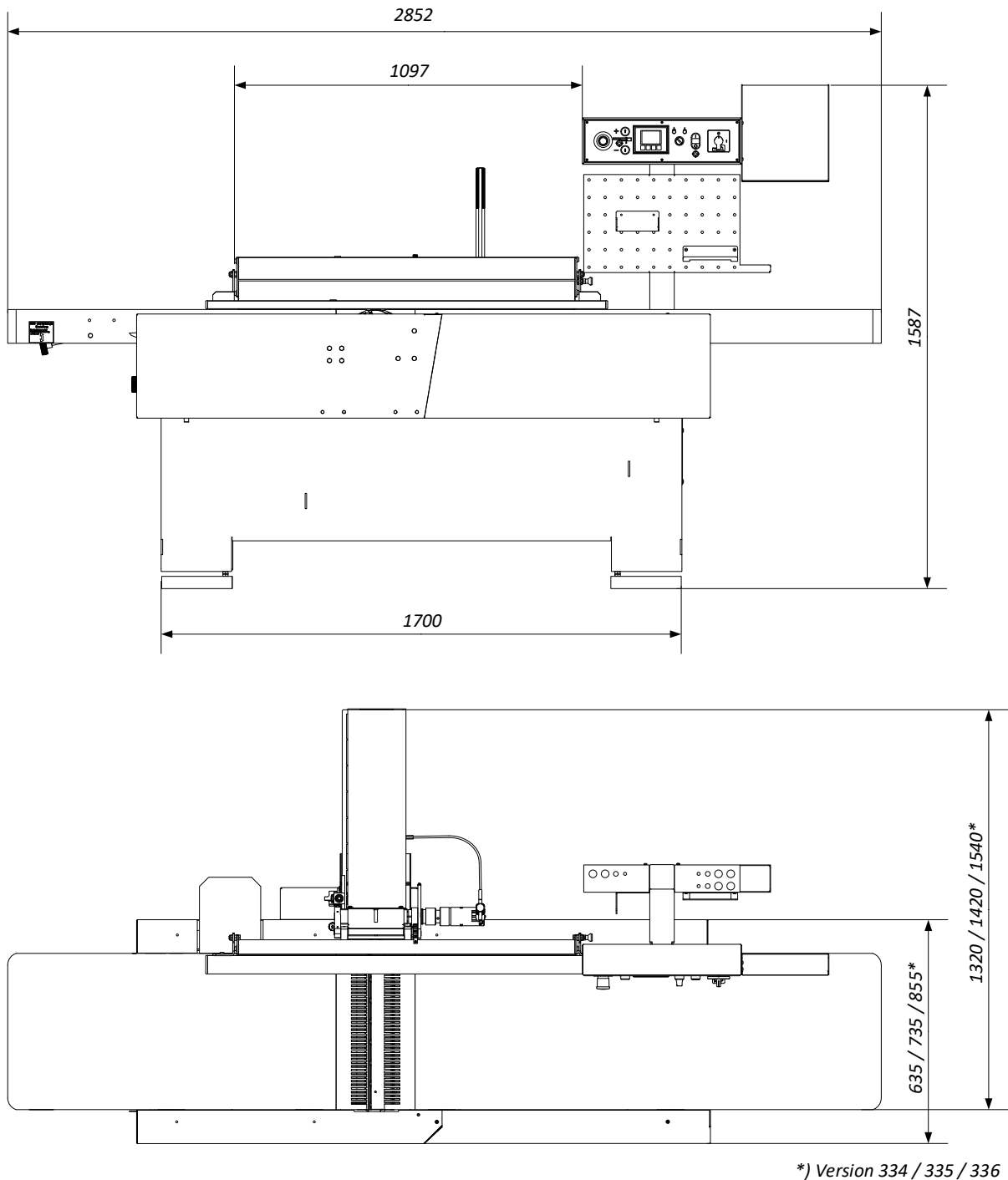

Figure 5: Dimensions top & side view

Subject to design and dimensional changes!

7.2 Side View

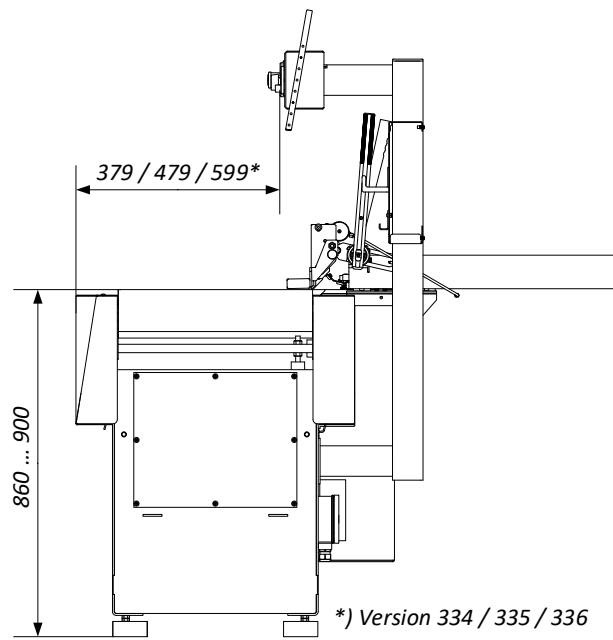

Figure 6: Dimensions side view

Subject to design and dimensional changes!

8 Installation and Connection

8.1 Check Delivery Conditions

Check the consignment for completeness and possible transport damage. In case of transport damage, please keep the packaging and inform the shipping company and the manufacturer immediately! Later complaints cannot be accepted.

8.2 Transport

The machine is delivered on a transport pallet and is bolted to the bottom of the pallet. The centre of gravity of the machine is approximately in the middle of the pallet.

- Drive a pallet truck between these timbers, lift the pallet only a few centimetres and move it to the immediate vicinity of the installation site.
- Dismantle the bolted fastening of the machine on the transport pallet.
- Move a forklift truck under the machine from the front and lift it a few centimetres.
- Lifting the machine off the pallet with the forklift truck.
- Move a lift truck from the front between the machine, lift it only a few centimetres and move it to the final installation location.

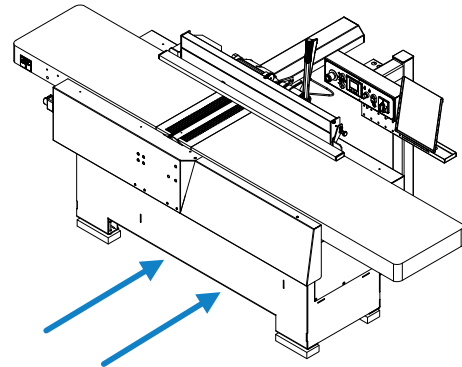

Figure 7: Transportation



Pay attention to the existing danger of tipping over during transport!

8.3 Installing the Machine

- A foundation is not required. The floor must have a load-bearing capacity corresponding to the weight of the machine.
- Before placing the machine on the ground, fit the four supplied underlays (U) under the feet. One screw with 3 corresponding SW17 nuts is attached to each machine base. The machine must be properly aligned with a 0.1 mm/1 m machine spirit level. To do this, loosen the lock nut (K) and adjust the height with nut (E). Then tighten the lock nut (K) again.
- There is a 13 mm diameter hole (B) on each of the four machine feet. If necessary, the machine can be bolted to the floor via these holes.
- The bare parts of the machine are greased to protect them from corrosion. Carefully degrease the parts protected against rust with petroleum or benzine.

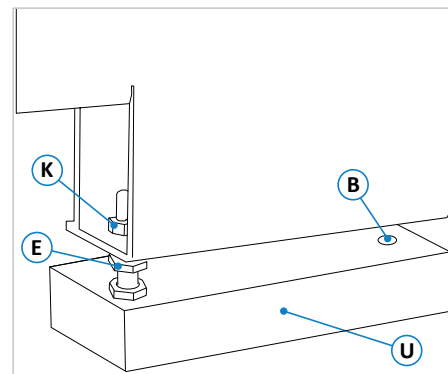





Figure 8: Adjustable underlay



Be aware of possible crushing hazards when placing the machine (from the pallet to the floor) by means of a forklift truck or overhead crane. Pay particular attention to your hands and feet and wear safety shoes and protective gloves as a precaution.



Danger to life when using a forklift truck! Keep a sufficient distance from the forklift truck and watch its speed. Vehicles with combustion engines also produce toxic exhaust gases. Wear a breathing mask if necessary.

	<i>It is essential that the machine is level! Check with spirit level!</i>
	<i>Dispose of the packaging material in an environmentally friendly way!</i>
	<i>Do not use nitro thinner for cleaning. Painted surfaces of the machine can be damaged.</i>
	<i>Fire hazard! Do not smoke and do not light an open fire.</i>

8.4 Temporary Storage

If the machine is not put into operation immediately after delivery, it must be stored carefully in a protected place. Carefully cover the entire machine so that neither dust nor moisture can penetrate.

The bare, non-surface-treated parts (e.g. the cast iron tabletop) are provided with a preservative. This must be checked regularly for effectiveness and renewed if necessary.

8.5 Lashing on a Transport Vehicle

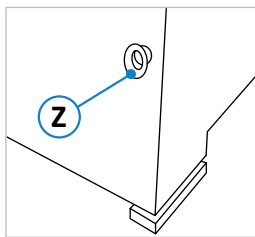

Figure 9: Lashing points

For transporting the palletised machine in a transport vehicle, a lashing point (Z) for one lashing strap each is fitted on all four sides of the machine.



A separate lashing strap must be used for each lashing point. All four lashing points must be tensioned individually on the loading area of the vehicle! The pallet must also be secured against slipping!

The responsibility for safe loading is borne by the respective shipper!

Please note the following when lashing in the transport vehicle:

- The loading area of the transport vehicle must always be clean and dry.
- The lashing straps used must be suitable for the total weight of the machine (see ⇒ 6.1).
- Fastening on the loading area is done by lashing down: This means that the transport pallet is secured by frictional locking. The load is pressed so firmly onto the loading surface that it can no longer slip. The clamping tool should have a high STF value at the frictional connection, e.g. long-lever ratchets.
- In addition, anti-slip mats should be used to provide even more safety.
- The ideal lashing angle (α) for tie-down lashing is 83° to and 90°. Therefore, the lashing straps should pull downwards approx. vertically. As the angle decreases, the pretensioning force of the lashing is reduced.
- Observe the permissible total weight of the transport vehicle.
- Ensure that the permissible axle loads of the transport vehicle are observed. The load must be distributed evenly on all axles of the vehicle.

8.6 Connecting the Extraction Unit

- The machine must be connected to an effective extraction system on-site.
- The suction nozzle has a diameter of 160 mm.
- All parts of the extraction system, including hoses, must be included in the earthing measure.

 **When flexible suction hoses are used, they must be flame-retardant.**

 **When the machine is switched on, the extraction system must start automatically.**

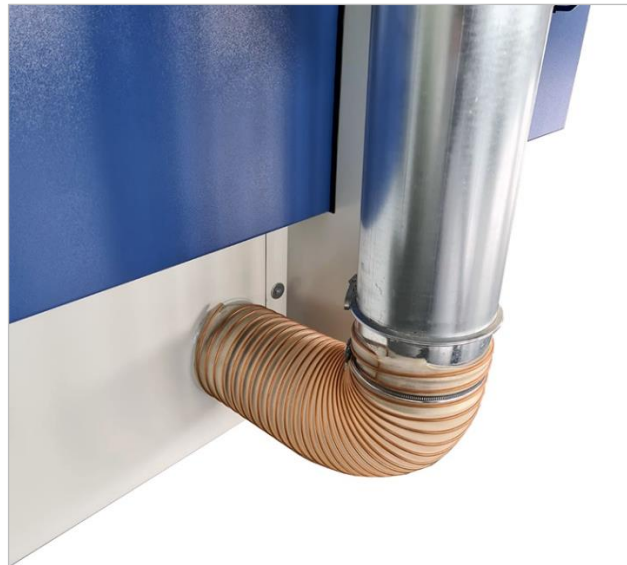

Figure 10: Connection to an extraction unit

Two signal generator lines for automatic switching of the extraction system can be connected to the terminals **23** and **24** of contactor **K1M** (see wiring diagram).

Installation only by a qualified electrician!

The air speed must be set in such a way that, with the extraction line connected and the tools stationary, an average air speed of

- 20 m/s (1450 m³/h) for dry chips,
- 28 m/s (2050 m³/h) with moist chips (moisture 18 % or more)

is achieved at the extraction nozzles.

Required negative pressure (at 20 m/s)
600 Pa

If the machine is properly connected to the extraction system, it can be assumed that the wood dust assessment value will be complied with (permanently and safely).

 • **The air velocity must be checked before initial commissioning and after significant changes.**
• **The extraction system must be checked daily for obvious defects after initial commissioning and monthly for effectiveness.**

8.7 Electrical Connections

	<i>The connection must be carried out by an authorised electrician!</i>
---	--

The electrical circuit diagrams are located in the control cabinet.

Please observe the specified nominal voltage 400 VAC / 50 Hz (3 phases / N / PE)!

- The connection to the mains (3 phases) is made at the terminal strip in the terminal box. The 3 phases are to be connected to the terminals “L1”, “L2” and “L3”.
- The protective earth wire (yellow/green) is to be connected to the terminal marked “PE”.
- Then close the cable gland again so that it is dust-tight.
- Observe the direction of rotation of the cutter block.



Figure 11: Electrical connection

	<i>If the direction of rotation is incorrect, two outer conductors must be swapped.</i>
---	--

	<i>Correct direction of rotation of the cutter block: Clockwise ↻ (viewed from the front).</i>
---	---

Only if the connection is carried out by an authorised electrician can a guarantee be given for the motor. In the event of a complaint, the electrician must confirm in writing that he has connected the machine in accordance with the regulations.

8.8 Backup Fuse

Motor Power	5.5 kW
400 V	20 A slow

	<i>The fault loop impedance and the suitability of the overcurrent protection device must be checked at the installation site of the machine.</i>
---	--

8.9 Supply Cable

Cu, 5-core. The cross-section must be determined on site by a qualified electrician!

The electrical wiring and connection must be carried out by a specialist in accordance with the applicable local EVU, VDE and EN regulations.

8.10 Machine Socket (Option)

A machine socket is optionally available as special equipment (see section ⇒ 16.3).

8.11 Attachment of Auxiliary Equipment

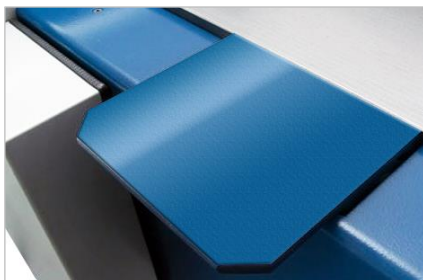

Figure 12: Console for auxiliary equipment

Auxiliary equipment such as angular jointing units or power feeders can be mounted on a console (9), which is already included in the scope of delivery of the machine.

Please note: Only power feeders equipped with a separate on/off switch may be used.

9 Components and Controls

9.1 Machine Components

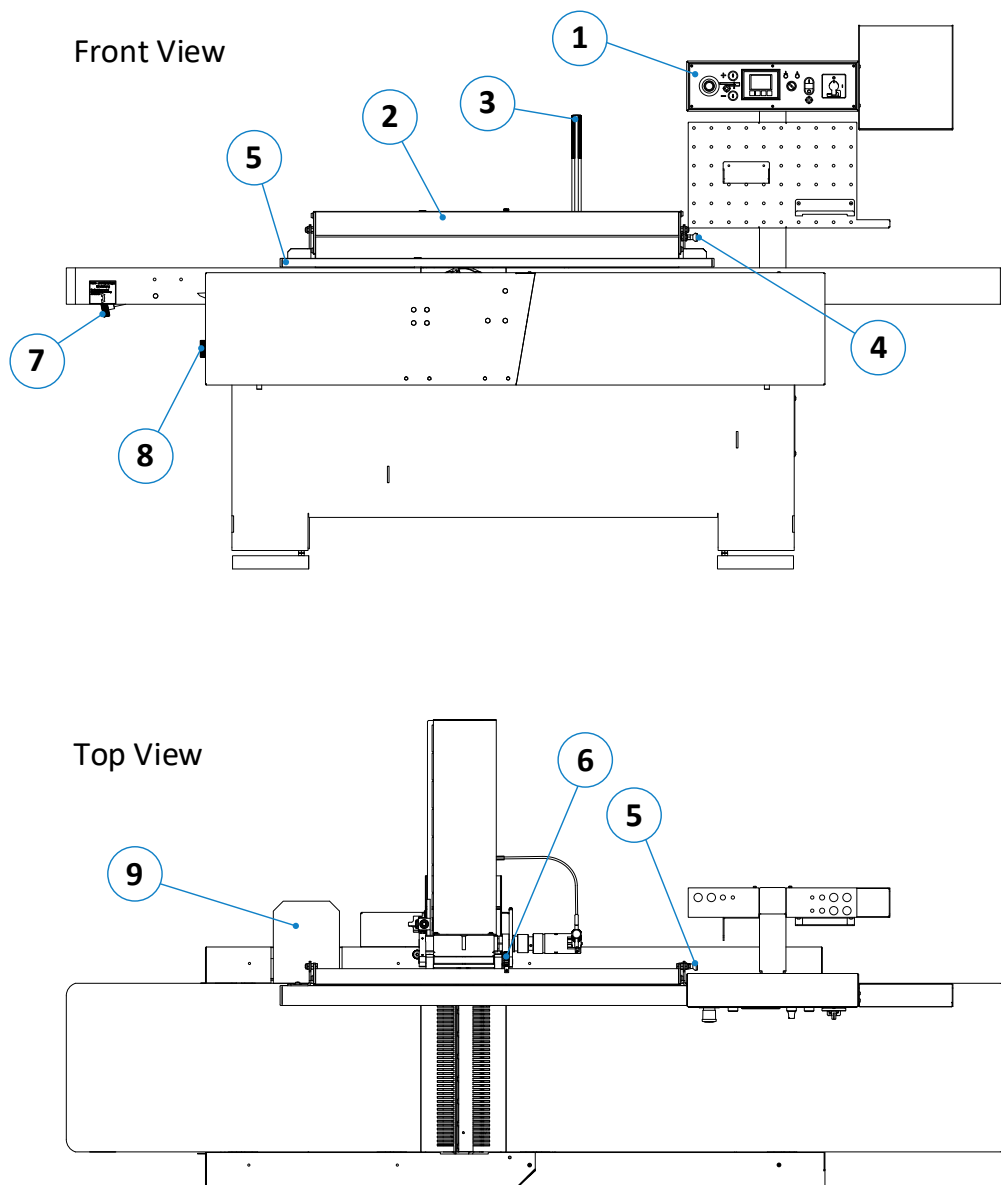

Figure 13: Components & controls (front view)

No.	Description	No.	Description
1	Control panel (details see section ⇒ 9.2)	6	Angle scale for fence
2	Fence	7	Hollow & pointed joint setting
3	One-hand lever for fence adjustment	8	Outfeed table adjustment
4	Locking pin for fence	9	Console for auxiliary equipment
5	Auxiliary fence		

9.2 Control Panel “Surface Planing & Jointing” (Details)

This section shows a detailed view of the control panel (1) shown in ⇒ Figure 13. This large view provides a better illustration of the respective operating elements.

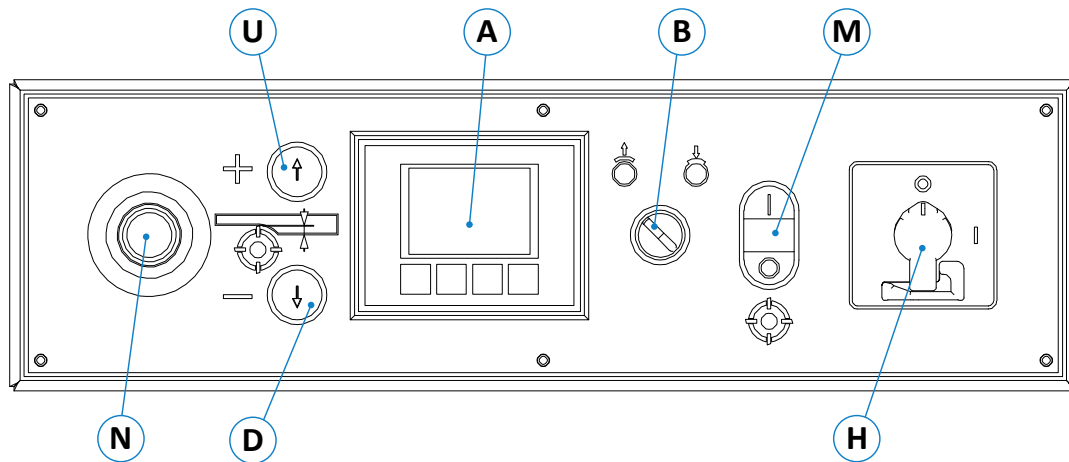



Figure 14: Control panel “surface planing & jointing”

No.	Description	No.	Description
H	Main switch	U	Move infeed table upwards
M	Cutter block ON/OFF switch	D	Move infeed table downwards
B	“Brake release” switch (left position = active)	N	Emergency stop button
A	Chip removal & hollow / pointed joint readout		

10 Commissioning

Read the operating manual and the chapter ⇒ 5 “Safety” carefully before commissioning and observe them.

	<p>Before switching on, check that</p> <ul style="list-style-type: none"> • there are no loose parts on the thickening table and that all tools have been removed, • the guards are fitted in accordance with regulations, • the extraction system is connected and in working order, • the direction of rotation is correct, • the V-belts are perfectly tensioned • and no persons are in a danger zone of the machine
---	---

10.1 Switching the Machine ON and OFF

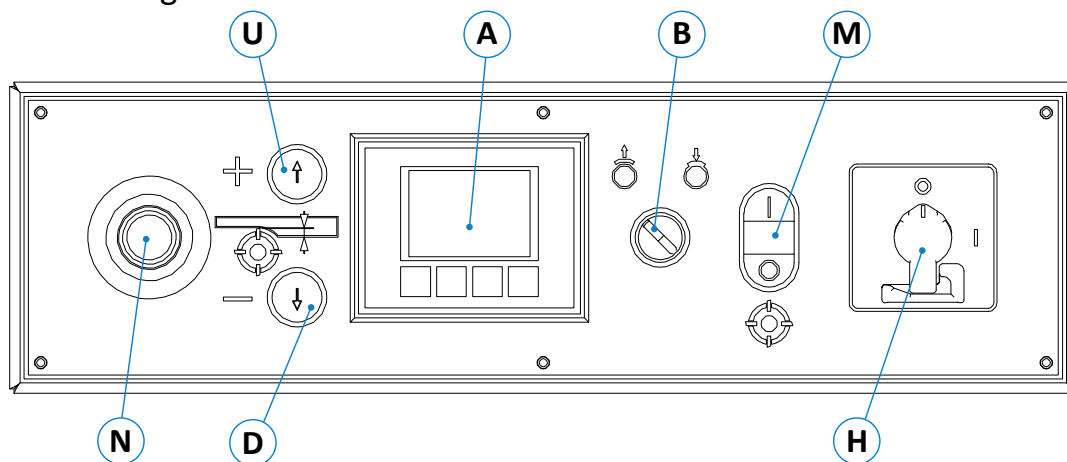

Figure 15: Control panel with main switch

10.1.1 Switching ON

- Turn the main switch (H) to position “I”.
- Start cutter block with push button (M):
→ The machine starts with automatic star-delta switching.

10.1.2 Switching OFF

- Switch off the cutter block with push button (M):
→ The machine is braked
- Turn the main switch (H) to position “0”.

Undervoltage protection ensures that the machine is switched off in the event of a power failure and does not restart automatically when power is applied again.

	<p>Note: The machine is equipped with a motor protection switch which switches off the motor in the event of an overload. In this case, wait a few minutes until the protective contacts have cooled down again. Only then can the machine be restarted.</p>
---	---

11 Machine Operation

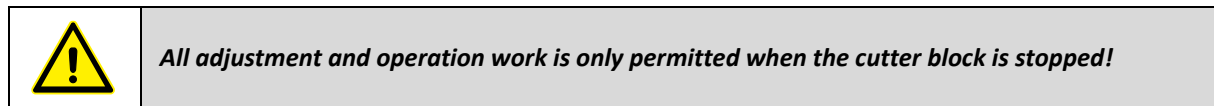

11.1 Electrical Chip Removal Adjustment

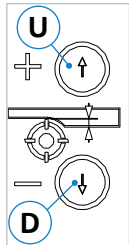

The chip removal thickness is set with the keys (U) and (D).

- Pressing button (D) lowers the infeed table
→ The chip thickness increases.
- Pressing button (U) raises the infeed table.
→ The chip thickness decreases.

Figure 16:
Chip removal

11.2 Hollow and Pointed Joint Adjustment

With the adjusting screw (S) under the outfeed table, the outfeed table can be inclined to the infeed table so that a hollow or a pointed joint is obtained.

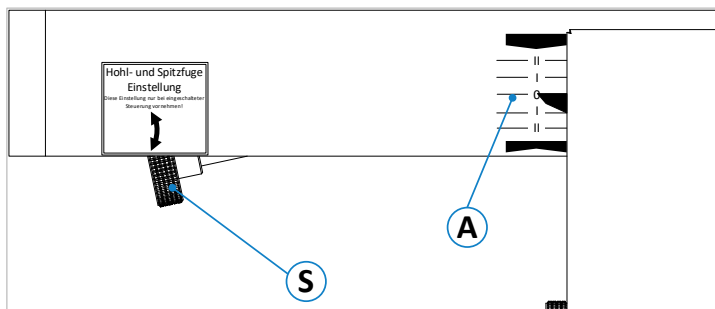

- Clockwise** ↻ - upwards -
> Pointed joint<
- Counterclockwise** ↺ - downwards -
< Hollow joint >

The analogue scale (A) enables the exact setting of the outfeed table. The current table status is shown on the digital indicator.

Figure 17: Hollow / pointed joint adjustment

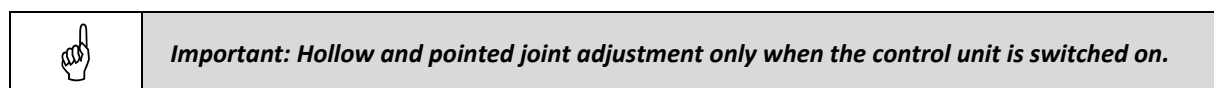

11.2.1 Calibrate Hollow and Pointed Joint on the Digital Indicator

If the adjusting screw (S) for the hollow and pointed joint adjustment has been adjusted whilst the digital display was switched off, the position will no longer correspond to the analogue scale when the digital indicator is switched on.

To synchronize the analogue and digital display, proceed as follows:

- Switch off the digital unit via the main switch (H).
- Use the adjusting screw (S) to reset the pointer to the original position on the outfeed table.
- Switch on the digital unit again
→ The digital display has taken over the position of the outfeed table.

Furthermore, the angle for the hollow and pointed joint of the digital display can be calibrated to the zero point. The procedure for this is described in detail in section ⇔ 12.2.

11.3 Adjusting the Outfeed Table

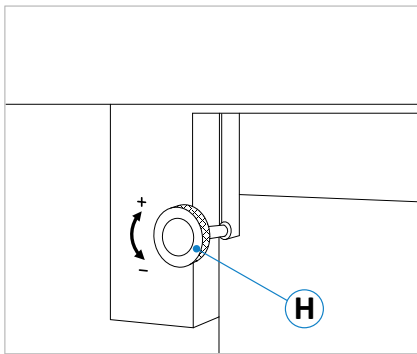

When changing the standard TERSA knives, readjustment of the outfeed table is not necessary!

Only if other cutter types are used and these are re-sharpened, it may be necessary to adjust the outfeed table via handwheel (H).

- | | |
|---------------------------|------------------------------|
| Clockwise ↻ | Direction +
↑ upwards ↑ |
| Counterclockwise ↻ | Direction –
↓ downwards ↓ |

Figure 18: Outfeed table handwheel



In the standard model, the delivery table is factory-set exactly to the flying circle of the cutter. It should only be adjusted if the knives have been set differently (for example, after sharpening)

11.4 Operating the Fence

11.4.1 Linear Adjustment

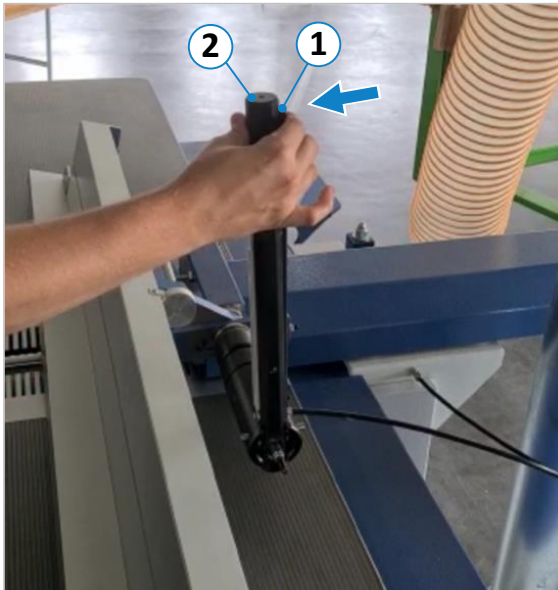

Figure 19: Clamping lever for fence



Figure 20: Linear adjustment of the fence

1. To move the fence forwards and backwards, press the two clamping levers (1) and (2) together.
2. Push the fence to the desired position and release both clamping levers again → The fence engages and is positioned.

11.4.2 Angular Adjustment up to 35°

To adjust an angle, the auxiliary fence must first be folded down (parallel to the table).



Figure 21: Activate angular adjustment



Figure 22: Adjusting angles

1. For angular adjustment, press both levers (1) and (2) to the left when released from each other and hold this position → The stepless locking of the angle adjustment opens.
2. By pushing the lever back and forth while holding it to the left, the angle can be adjusted to the desired position by means of the angle scale (6).
3. Resetting to 0° is done in the same way.
4. If an angle of more than 35° is required, you must follow up with the lever (see ⇨ next page).

11.4.3 Angular Adjustment > 35°

1. Push the lever (1) to the right (the lever disengages) and slide it backward or forward to obtain the necessary follow-up distance. Then release the lever → The lever has a new starting position.
2. To adjust the angle of the fence, push the lever (1) to the left and hold this position → The stepless locking of the angle adjustment opens. The angle can be adjusted to the desired position by pushing the lever back and forth while simultaneously holding it to the left.
3. Resetting to 0° is done in the same way.
4. To adjust the lever to another position, push the lever to the right (the lever disengages) and push it backwards or forwards and release it at the desired position.

11.4.4 Maintenance of the fence

If the fence no longer engages correctly when the levers (1) and (2) are released, or if it can be adjusted without the operating lever, or if the fence scrapes during adjustment and rattling noises occur at the lock-in rail, the fence must be readjusted..

For adjustment, follow the instructions in the section ⇒ 15.4 “Adjust the workpiece fence“.

11.4.5 Using the Auxiliary Fence

- For planing narrow workpieces or for joining work, use the swivelling auxiliary fence located above the main fence.
- When not in use, pull the locking bolt (B) outwards, swivel the fence to the upper position (see ⇒ Figure 23) and engage the locking bolt (B) back into place.

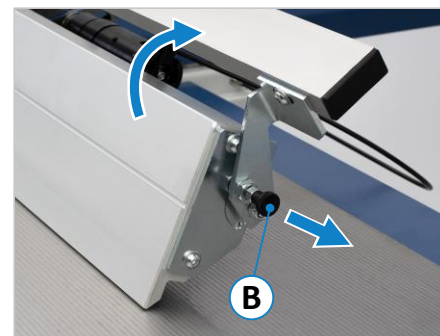

Figure 23: Auxiliary fence

11.4.6 Push Block & Push Handle

- When planing short workpieces, use the supplied push block (Z) or a self-made push block in combination with the manual push handle (S) also included in the scope of delivery.
- See ⇒ Figure 24: When not in use, the push block can be stored in the tool tray under the operating panel. There is also a suitable storage space for the manual push handle on the rear side.



Figure 24: Push block & push handle

11.5 Planer Guard TXF 1570

The standard TXF 1570 planer guard has a bridge that can withstand very high loads. It can raise parallel to the machine tables to a height of max. 60 mm.

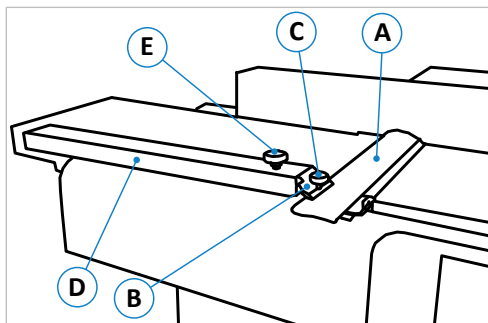

Figure 25: Planer guard TXF 1570

TXF 1570 Components:

- A Protective bridge
- B Bridge support
- C Locking lever of the bridge
- D Planer guard arm
- E Locking screw for height adjustment

11.5.1 Flat Planing

- Loosen the bridge lock (C) and push the bridge all the way against the planing fence.
- Clamp the bridge lock again.
- Set the height of the bridge slightly higher than the workpiece using the locking screw (E).
- Now the workpiece is passed under the bridge, whereby the bridge is pressed down with one hand.

The underside of the bridge, regardless of its height, is always parallel to the tables and is automatically held in position.

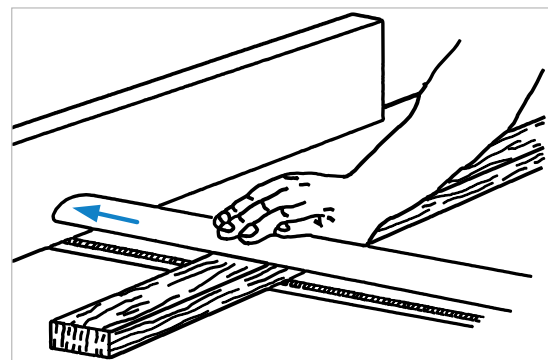

Figure 26: Guard setting for flat planing

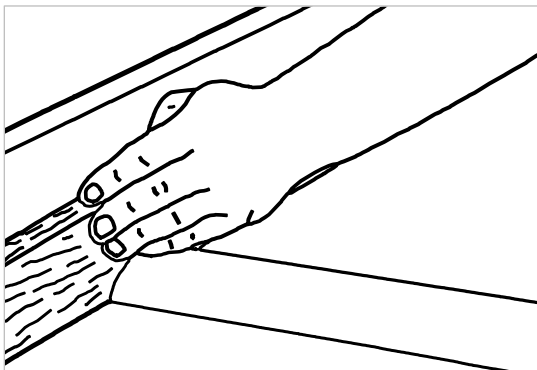

Figure 27: Guard setting for edge jointing

For several operations, the workpiece is brought back over the bridge onto the infeed table. During this process, the bridge is lowered and then returns to its initial position.

11.5.2 Edge Jointing

- Set the bridge all the way down using the locking screw (E).
- Adjust the bridge with the locking device (C) so that the workpiece can just pass between the bridge and the fence.

11.6 Optional Planer Guards SUVAMATIC & TX MATIC

The following planer guards are optionally available (see also options in section ⇒ 16.2):

1. **SUVAMATIC** - with 2-part fold-down cover and spring-loaded contact pressure.
2. **TX MATIC** - with 2-part fold-down cover and spring-loaded contact pressure with rollers.

Information and instructions on operation and maintenance, can be found in the [operating manual of the manufacturer](#).

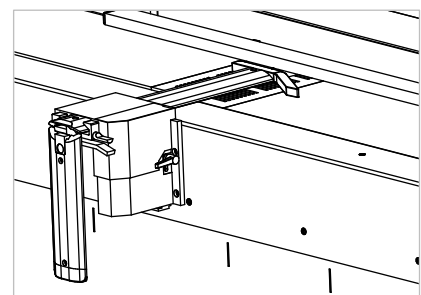

Figure 28: Type SUVAMATIC (example)

12 Calibrating the Digital Indicator

12.1 Calibrate Chip Removal

First of all, it is necessary to check whether calibration of the chip removal is required. To do this, move the infeed table all the way up to the stop using the button for the electrical height adjustment. The digital display should indicate **"0.0 mm"**. If not (see ⇒ Figure 29) If not, the unit must be recalibrated.

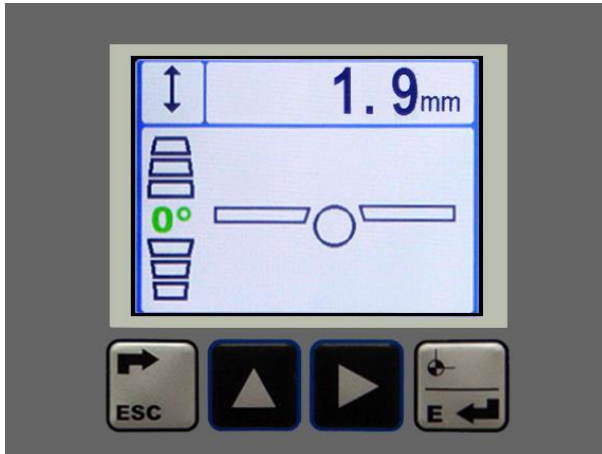

Figure 29: Calibrate chip removal 1

1. Press button **"ESC"** for approx. 5 seconds.

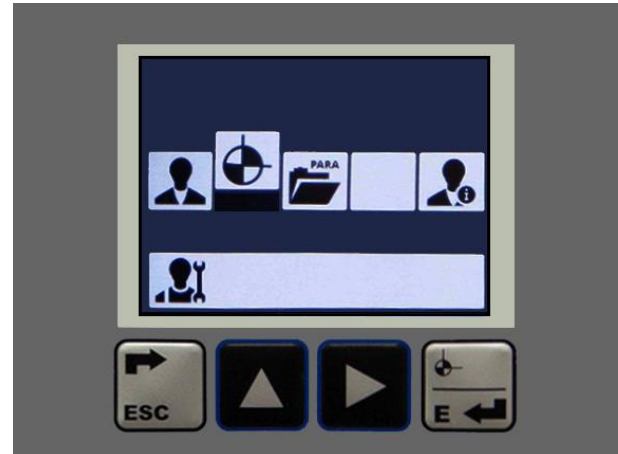

Figure 30: Calibrate chip removal 2

- The mask shown in the figure above appears.
2. Press button **▶** repeatedly until the **"Zero point"** tab (as shown in the picture above) is activated.
 3. Then press the rightmost button **"Enter"**.



Figure 31: Calibrate chip removal 3

4. The mask shown in the picture above appears with the arrow symbol \updownarrow in the upper left corner.
5. If the angle symbol \sphericalangle appears here, then switch over with the button **▲** until the \updownarrow symbol appears in the upper left corner.

In the example above, the display for chip removal has been misadjusted by 1.9 mm. The value is to be reset to 0.0 mm by the calibration process.



Figure 32: Calibrate chip removal 4

6. Press the rightmost button **"Enter"**.
→ The mask shown in the figure above appears.
7. The code **007440** must now be entered here. Use button **▶** to select the respective digit and then set the desired number with button **▲**.
8. After entering the code **007440**, press the **"Enter"** button 3 times.
9. Then press the **"ESC"** button 2 x to complete the process → The unit is now calibrated
10. The start screen now displays **0.0 mm**.

12.2 Calibrating Angles for Hollow and Pointed Joints

First, the digital indicator must be switched off with the main switch, and then the analogue scale display for the hollow and pointed joint must be set to 0° (see ⇒11.2). Then switch on the digital unit again. In the left half of the display, none of the 6 angle segments should now be "green" and the two symbols for the infeed and outfeed tables should be in horizontal position. If one of the 6 segments is green and a table symbol is not horizontal (see ⇒ Figure 33), the angle of the digital indicator must be recalibrated.

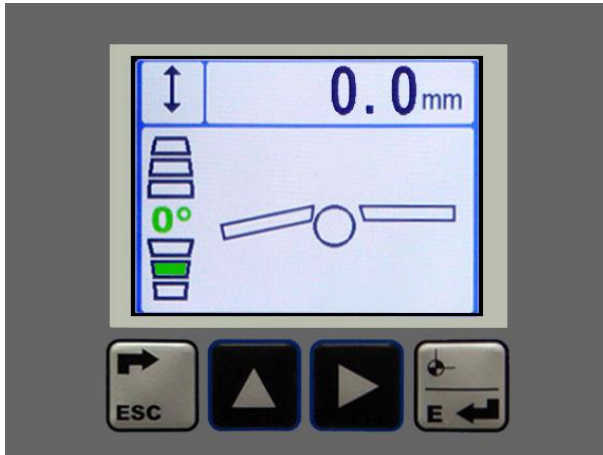

Figure 33: Calibrate angle 1

1. Press button "ESC" for approx. 5 seconds.

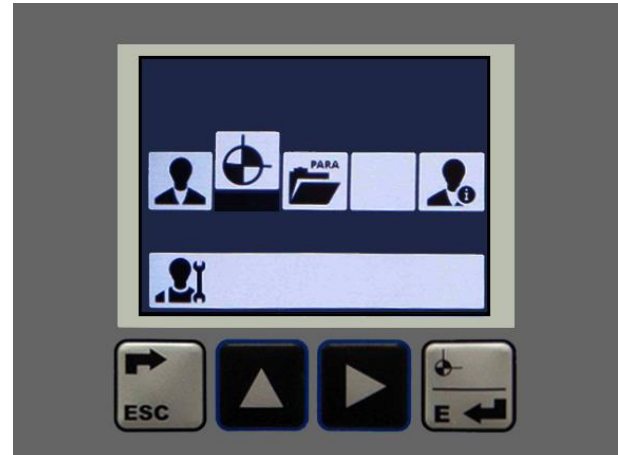

Figure 34: Calibrate angle 2

- The mask shown in the figure above appears.
2. Press button ► repeatedly until the "Zero point" tab (as shown in the picture above) is activated.
3. Then press the rightmost button "Enter".



Figure 35: Calibrate angle 3

4. The mask shown in the picture above appears with the arrow symbol ↗ in the upper left corner.
5. If the arrow symbol ↓ appears here, then switch over with the button ▲ until the ↗ symbol appears in the upper left corner.



In the example above, the value for the angle has been misadjusted by -271 increments. The value is to be reset to 0 increments by the calibration process.



Figure 36: Calibrate angle 4

6. Press the rightmost button "Enter".
→ The mask shown in the figure above appears.
7. The code **007440** must now be entered here. Use button ► to select the respective digit and then set the desired number with button ▲.
8. After entering the code **007440**, press the "Enter" button 3 times.
9. Then press the "ESC" button 2 x to complete the process → The unit is now calibrated
10. In the start screen, no angular segment is now lit green and both table symbols are horizontal.

13 Changing the Planer Knives

	<p>Switch off the machine during maintenance and repair work and secure it against being switched on again unexpectedly! Lock the main switch with a padlock!</p>
	<p>Even when stationary, cuts from the knives are possible!</p>
	<p>Always wear protective gloves when changing the knives!</p>

13.1 Changing the TERSA Knives on an All-Steel Cutter Block (standard)

Only use original replacement planing knives from the manufacturer. The blades must always be the same length as the maximum planer width (Version 334 = 410 mm / Version 335 = 510 mm / Version 336 = 630 mm).

- Knock back the pressure bar segments using a hammer in combination with the brass wedge (3) included in the delivery or a piece of wood. Please do not use a screwdriver or similar made of steel, otherwise the blades will be damaged!
- Pull out the knife (1) sideways
→ Turn the knife resp. replace and reinsert it.
- The knives are automatically tensioned to the correct flight circle by the centrifugal force acting on the pressure bars (2).
- To ensure absolute clamping of the knives after changing the knives, an initial planing with hardwood over the entire planing width is necessary.

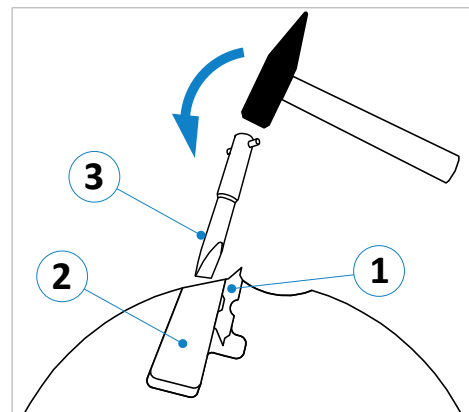

Figure 37: Changing TERSA knives

Suitable replacement knives for your Tersa cutter can be found in section ⇒ 16.1.1.

13.2 Changing the Knives on PANHANS Traditional Cutter Block (Option)

Permitted replacement knives: **35 x 3 x 410 (334) | 35 x 3 x 510 (335) | 35 x 3 x 630 (336)**

Correctly ground and adjusted knives are the basic prerequisite for clean and precise working of the machine. The following measures are generally to be applied:

- Thoroughly clean the knives, wedge bars, contact surfaces on the shaft as well as the contact surfaces of the adjusting devices.
- Sharpen, hone and balance the knives in parallel.
- Check the knives for straightness and clean grinding before insertion.
- The adjustment may only be made with PANHANS adjusting devices (see ⇒ 13.2.1 and ⇒ 13.2.2).
- Generally use only high-quality knives.
- The knives (**M**) may only be sharpened to such an extent that a minimum clamping length of 20 mm can be maintained with a knife protrusion of max. 1 mm (see ⇒ Figure 38).

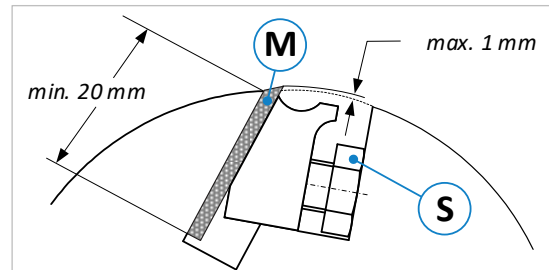

Figure 38: Traditional cutter block

	<p>To replace the knives, use only the PANHANS cutter adjusting devices included in the scope of delivery or the magnetic quick adjusters (type 1533), which are available as accessories. The manufacturer is not liable for damage caused by a deviating or improper procedure!</p>
--	--

13.2.1 PANHANS Cutter Block Adjusting Devices

The standard cutter block adjusting devices are already included in the scope of delivery when ordering the optional PANHANS traditional cutter block. The correct adjustment is carried out as described below:

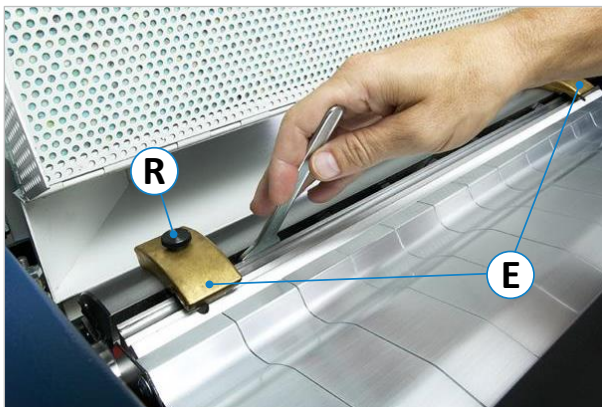

Figure 39: Standard adjusting devices

- Using a flat spanner SW17 (as shown in ⇒ Figure 39), loosen all the screws (**S**) in sequence and remove the blunt knives (**M**), see ⇒ Figure 38.
- After thoroughly cleaning all parts and contact surfaces, insert the new or sharpened knife (**M**) into the shaft groove and tighten lightly with two screws (**S**).
- Tighten the two adjusting devices (**E**) with the knurled screws (**R**) in the threaded holes of the cutter block.
- Loosen the two screws (**R**) again → The pressure springs will force the knife against the adjusters.

- Starting from the middle screw, tighten all the cutter block screws alternately in an outward direction.
- After approx. 5 minutes of running, retighten the cutter block screws.

	<p>Maximum permissible knife protrusion over the shaft base body = 1 mm.</p>
--	---

	<p>The optimum tightening torque for the cutter block screws is 32 Nm. Please do not use an extension or a hammer!</p>
--	---

Suitable replacement knives and accessories for the traditional cutter block can be found in section ⇒ 16.1.2.

13.2.2 Magnetic Quick Adjusters 1533 (Option)

The knives can be adjusted even faster, more precisely and more comfortably with the two optionally available magnetic quick adjusters 1533 (refer to section ⇒ 16.1.2).

Before starting, make sure that the clamping surfaces of the cutter block and the cutter wedges are clean. The planing knives must always be sharpened, honed and balanced in parallel.

Then proceed as described below:

- Using a flat spanner SW17, loosen all screws (8) one after the other and remove the blunt knives.
- Place the two adjusters 1533 (Accessories ⇒ 16.1.2) with the magnetic shoes (4) onto the knife shaft body (not in the knife area) and press the brass stop piece (5) with the adjusting nut (2) down to the shaft body diameter.
- Turning back the adjusting nut (2) gives the blade protrusion. One graduation point (3) on the neck of the adjusting nut corresponds to 0.1 mm.
- The blade protrusion on all thickness planers is 1.0 mm. The adjusting nut (2) is to be turned back by 10 pitch points (3).
- Then insert the new resp. sharpened knives (1), press them into the knife holder of the cutter block with a piece of wood and screw them slightly tight, so that the spring-loaded pin (6) rests against the cutter body (clamping screw side).
- The knife can be pressed up to the brass stop piece by the spring (7).
- Then tighten the clamping wedge (9) from the centre outwards with the screws (8) and the adjustment is finished. The adjusters must not be placed tilted or angled, otherwise the adjustment will be inaccurate.
- After approx. 5 minutes of running, retighten the cutter block screws.



Figure 40: Magnetic quick adjusters 1533

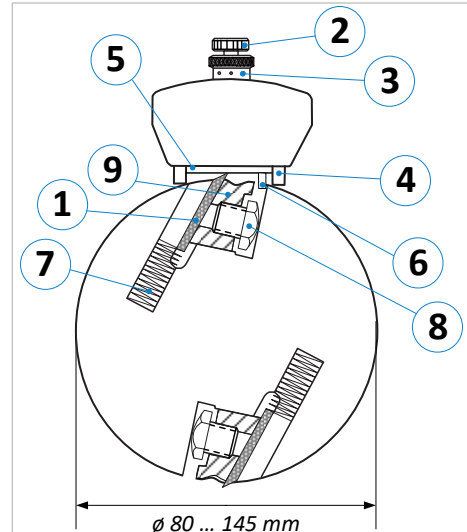



Figure 41: Adjustment of the cutter block

	<p>Maximum permissible knife protrusion over the shaft base body = 1 mm</p>
	<p>The optimum tightening torque for the cutter block screws is 32 Nm. Please do not use an extension or a hammer!</p>

Suitable replacement knives and accessories for the traditional cutter block can be found in section ⇒ 16.1.2.

13.3 Changing the Knives on PANHANS Spiral Cutter Block (Option)

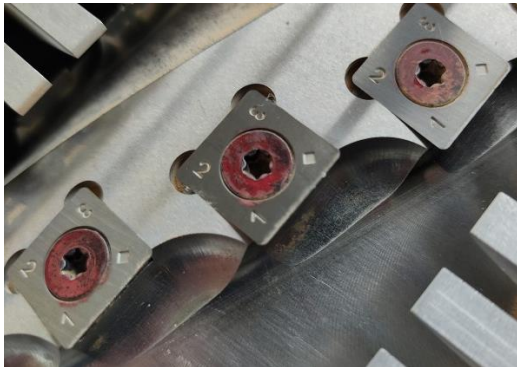

Figure 42: : Spiral cutter carbide inserts

The optionally available PANHANS spiral cutter block consists of 6 spiral rows of cutters, each segmented with (depending on the machine version 16, 22 or 27) special 4-fold carbide inserts.

Only the PANHANS service set for spiral cutter shafts¹ (see section ⇒ 16.1.3) is to be used for turning or replacing the cutting inserts.

The set includes a torque spanner for the M6 x 15 Torx screws, which ensures the correct tightening torque for mounting the cutting plates and thus optimal function.

13.3.1 Procedure for Changing the Knives

Changing or turning the cutting inserts is very simple:

- Unscrew the Torx screws of the cutting insert and remove it from the socket.
- Clean the insert holder with the accessories included in the set.
- If the plate is to be turned over, clean it from all sides (the plates are numbered for better orientation).
- Now replace the cutting insert or turn it to the position of the next number. Then tighten it with the torque spanner until it locks into place.



Only use the PANHANS service set for spiral cutter shafts to change and turn the cutting inserts. The manufacturer is not liable for damage caused by a deviating or improper procedure!

13.3.2 Advantages of the PANHANS Spiral Cutter Block

1. When using a spiral cutter block its “pulling cut” significantly improves the cutting quality and thus the planing result.
2. Another advantage is the simplified knife replacement due to segmentation and reduced knife changing times. In the case of minor damage or blunt spots, it is usually sufficient to simply turn or replace the cutting inserts at the damaged spots. It is not necessary to replace the entire blade.
3. A spiral cutter block produces much smaller chips and thus additionally protects the extraction unit.
4. The use of a spiral cutter block ensures lower power consumption and also reduced noise emission.

¹ Also included in the set are 1 litre of resin dissolving concentrate, one steel and one brass cleaning brush, 10 reversible cutting inserts (15 x 15 x 2.5 mm), 5 Torx screws (M 6 x 15) and two T20 bit inserts for the torque spanner. The set is supplied in a practical storage case.

This and other accessories for your spiral cutter block can be found in section ⇒ 16.1.3.

14 Troubleshooting

Proceed systematically when searching for the cause of a malfunction. If you are unable to find the fault or to remedy the malfunction, contact our customer service department.

Phone number: 0049 7571 / 755 - 0

Before you call us, please follow these steps:

- Make a note of the type, machine number and year of production (see nameplate).
- Keep this operating manual (and any circuit diagrams) to hand.
- Describe the fault to us in detail so that a competent remedy can be found.

Fault	Possible Cause	Remedy
The cutter block does not start	No voltage	→ Check power supply
	Control fuse defective	→ Replace fuse (see wiring diagram)
	Main switch defective	→ Replace main switch
	Motor defective	→ Replace motor
	V-belt torn	→ Replace V-belt
	Emergency stop is locked	→ Unlock emergency stop
Motor no longer brakes in intended time (10 sec.)	Brake pads are worn	→ Readjust brake (⇒ 15.2) → If necessary, contact customer service
Cutter block does not run up cleanly	V-belt too loose	→ Retighten the V-belt (see section ⇒ 15.3)
Machine planes hollow or pointed joint, despite correct setting on the in-feed table	The outfeed table does not match the flying circle of knives	→ Readjust outfeed table (see section ⇒ 11.3)
The analogue hollow and pointed joint position on the table does not correspond to the digital display	Adjusting screw for hollow/pointed joint was adjusted with digital unit switched off	→ Synchronise bot s (see section ⇒ 11.2.1)
The digital indicator cannot be set to 0	Device must be calibrated	→ Recalibrate indicator (see section ⇒ 12.2)

15 Maintenance and Inspection



Before any maintenance and inspection work is carried out, chapter ⇨ 5 "Safety" must be read carefully and observed!

Operational malfunctions caused by insufficient or improper maintenance can result in very high repair costs and long machine downtimes. Regular maintenance is therefore essential.

- Clean the machine daily.
- Check all sliding or rolling parts weekly for smooth running and lubricate with a thin-bodied oil if necessary
- Inspect electrical equipment/components weekly for externally visible damage and have them repaired by a qualified electrician if necessary.
- Immediately remove and replace damaged guards. Never work with damaged equipment!
- Before starting work, check the extraction system for full function every day.
- The extraction system must be checked for obvious defects before initial commissioning, daily and monthly to ensure its effectiveness.
- The air velocity to the extraction system must be checked before the initial commissioning and after significant modifications.
- Do not use the machine until these conditions are met.

Due to the different operating conditions, it is not possible to determine in advance how often a wear check, inspection or maintenance is required. Inspection intervals are to be determined appropriately according to the respective operating conditions.

15.1 Lubrication Instructions



Switch off the machine during maintenance and repair work and secure it against being switched on again unexpectedly! Lock the main switch with a padlock!

The machine was subjected to a longer test run at the factory and has already been lubricated ready for operation. Relubrication before commissioning is therefore not necessary.

The roller bearings of the machine are maintenance-free.

- Check all sliding or rolling parts weekly for smooth running and lubricate with a thin oil if necessary.
- Apply weekly a few drops of oil on the threads of clamping and adjusting levers.
- Always use the same type of grease/oil.

15.2 Readjust Motor Brake

If the cutter block no longer comes to a standstill within 10 seconds when braking, the motor brake must be readjusted.

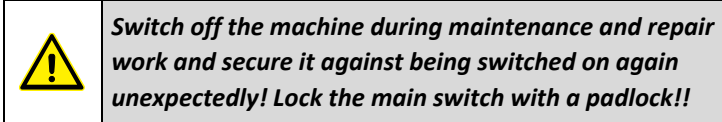

Procedure:

- Turn off the main switch (**H**) to position “**0**” and lock it.
- A socket wrench SW 17 is required for the adjustment.
- Place the socket wrench on the adjusting nut (⇒ Figure 43) and adjust it clockwise by approx. 1/8 turn.



Figure 43: Readjust motor brake

15.2.1 Checking the Adjustment

- Before checking the adjustment, make sure that the V-belt is well tensioned (see ⇒ 15.3).
- Then unlock the main switch again and switch on (position “**1**”).
- Turn brake release switch to “**Released**” position.
 - It must now be possible to turn the V-belt pulley by hand.
 - By turning, you can now check whether the brake is dragging or has been adjusted too much.
 - If the brake drags, the readjustment made must be minimally returned again.



- Now turn the brake release switch back to “**Normal Operation**”
- Start the cutter block and wait until the machine has reached its full speed.
- Then switch off the machine and check the braking time until standstill.
- If the braking time is still above 10 seconds, repeat the setting procedure (described in section ⇒ 15.2) and check again.
- If the adjustment does not lead to success, please contact our customer service.

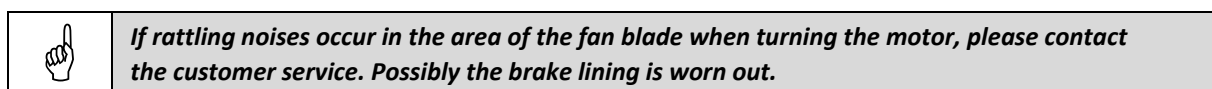

15.2.2 Replace Motor Brake

If the adjustment of the motor brake described above does not lead to the desired success, the motor brake must be replaced. To do this, first note down the type designation and other information on the type plate of your motor. Then contact our customer service (phone 0049 7571 / 755 - 0) to order a suitable new brake.

15.3 Tighten / Replace the V-Belt



Switch off the machine during maintenance and repair work and secure it against being switched on again unexpectedly! Lock the main switch with a padlock!!

- Turn off the main switch (**H**) and lock it.
- Then remove the belt drive cover on the rear of the machine.
- Move the main fence completely to the front.
- Loosen the nuts (**M**) on the angle plate (**W**) and press the motor block down. A lever made from a piece of wood is very suitable for this purpose. Then tighten the nuts (**M**) again.
- Do not tighten the V-belt (**R**) too much. It is correctly tensioned when it can be pressed through between the V-belt pulleys by about 1 cm with a lateral force of approx. 2 kg.
- Remount the rear cover.

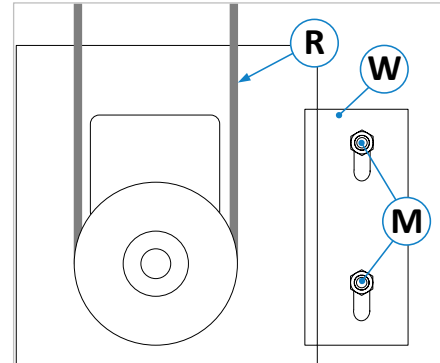

Figure 44: Tighten the V-belt

To replace the V-belt, loosen the screws and lift the motor. Then pull the worn belt off the pulleys and fit the new one. To tension, proceed as described above.

15.4 Adjust the workpiece fence

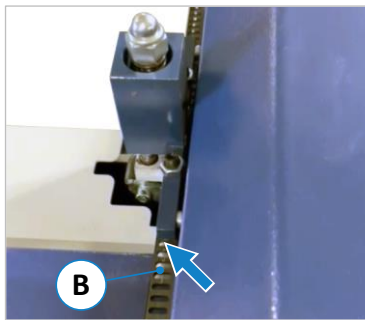

Figure 45: Lock-in rail

If one of the following problems occurs, the workpiece fence must be re-adjusted:

- If the fence no longer engages correctly when the operating levers (1) and (2) shown in ⇒ Figure 19 are released, or if it is possible to move the fence without using the two operating levers.
- If the fence brushes during adjustment and chattering noises occur on the lock-in rail (B).

→ Proceed as described below for readjustment.

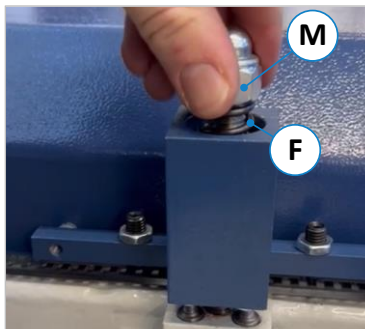

Figure 46: Remove nut + spring

1. Loosen nut (M), unscrew completely and remove tension spring (F).

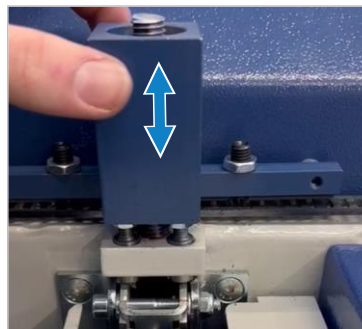

Figure 47: Check mechanics

2. Ensure that the guide block moves smoothly by moving it up and down. If it is difficult to move, the mechanism is dirty or damaged.

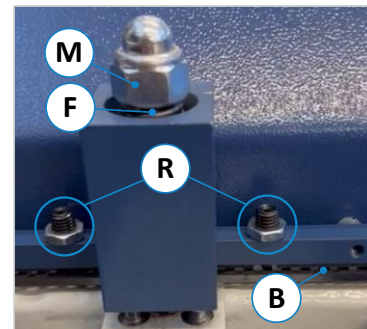

Figure 48: Adjust stop bolts

3. Reinsert spring (F) and then tension by hand with nut (M).
4. Adjust the two stop bolts (R) so that they engage properly into the lock-in rail (B) and the fence can no longer be moved by hand (see 5.).

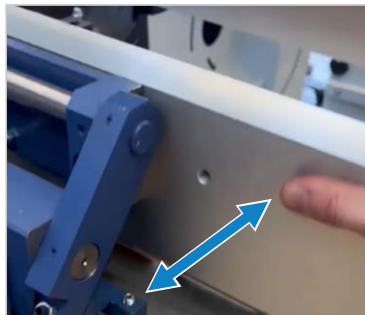

Figure 49: Check adjustment

5. Make sure that the fence cannot be moved without the operating levers by pushing and pulling it back and forth.
6. Correct the setting (refer to step 4.) slightly, if necessary.

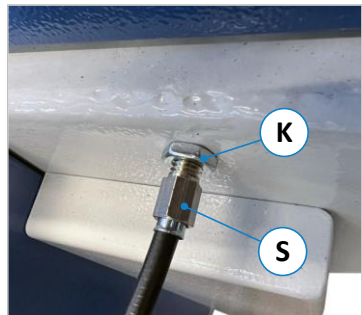

Figure 50: Tension Bowden cable

7. Then the pretension of the Bowden cable must be adjusted. To do this, loosen the lock nut (K) and adjust the tensioning nut (S) accordingly:

↻ = Increase tension

↻ = Reduce tension

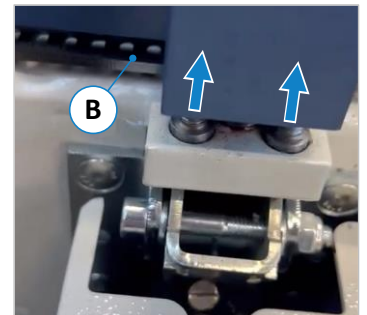

Figure 51: Check tension

8. Tension the Bowden cable so that the locking mechanism lifts off cleanly when the two operating levers are pressed together (see direction of arrow). In addition, the fence must not brush against the bottom of the lock-in rail (B) when moving via the control levers (1) and (2).

16 Options and Accessories

16.1 Cutter Blocks and Planing Knives

16.1.1 Accessories for Tersa Cutter Blocks (Standard)

Article	Description	Art.-No.
TERSA Disposable Reversible Knife 334 20	Standard quality 410 mm for the TERSA Cutter Block.	4094
TERSA Disposable Reversible Knife 335 20	Standard quality 510 mm for the TERSA Cutter Block.	4095
TERSA Disposable Reversible Knife 336 20	Standard quality 630 mm for the TERSA Cutter Block.	4096
TERSA Disposable HSS Reversible Knife 334 20	HSS steel quality 410 mm for the TERSA Cutter Block.	4121
TERSA Disposable HSS Reversible Knife 335 20	HSS steel quality 510 mm for the TERSA Cutter Block.	4122
TERSA Disposable HSS Reversible Knife 336 20	HSS steel quality 630 mm for the TERSA Cutter Block.	4126
Brass Wedge	For loosening the pressure bar segments when changing knives.	7003.0050

16.1.2 Accessories for Traditional Cutter Block (Option)

Article	Description	Art.-No.
Magnetic Quick Adjusters Type 1533	With strong magnetic adhesion, the planing knife protrusion is accurate to 1/10 mm due to the fine adjustment. Suitable for all cutter block diameters from 80 - 145 mm.	2004
Strip Planer Knife 1505 Standard for 334 20	PANHANS-Granat 410 x 35 x 3 mm, standard quality for PANHANS Traditional Cutter Block shaft, made of continuous cut steel.	3304
Strip Planer Knife 1505 Standard for 335 20	PANHANS-Granat 510 x 35 x 3 mm, standard quality for PANHANS Traditional Cutter Block shaft, made of continuous cut steel.	3306
Strip Planer Knife 1505 Standard for 336 20	PANHANS-Granat 630 x 35 x 3 mm, standard quality for PANHANS Traditional Cutter Block shaft, made of continuous cut steel.	3308
Strip Planer Knife 1505 HSS for 334 20	PANHANS-Granat 410 x 35 x 3 mm, standard quality for PANHANS Traditional Cutter Block shaft, made of HSS steel.	3313
Strip Planer Knife 1505 HSS for 335 20	PANHANS-Granat 510 x 35 x 3 mm, standard quality for PANHANS Traditional Cutter Block shaft, made of HSS steel.	3315
Strip Planer Knife 1505 HSS for 336 20	PANHANS-Granat 630 x 35 x 3 mm, standard quality for PANHANS Traditional Cutter Block shaft, made of HSS steel.	3316
Cutter Block Pressure Bars 410 mm for 334 20	Balanced, with screws R 1/4", SW 17 (supplied in pairs).	4087
Cutter Block Pressure Bars 510 mm for 335 20	Balanced, with screws R 1/4", SW 17 (supplied in pairs).	4088
Cutter Block Pressure Bars 630 mm for 336 20	Balanced, with screws R 1/4", SW 17 (supplied in pairs).	4131
Spare Screws for Cutter Block	Standard version, height approx.21 mm (hardened, R 1/4", SW 17).	4107
Flat Spanner SW17	For cutter block screws with spanner size 17 mm.	4113
Cutter Block Pressure Spring	For lifting the knives and for easier adjustment of the knives with magnetic quick adjusters (see ⇒ Art.-No.: 2004 above).	4114

16.1.3 Accessories for Spiral Cutter Block (Option)

Article	Description	Art.-No.
Solid Steel Cutter Block for 334 20	With 6 rows of spiral knives, 16 rotatable and replaceable carbide inserts with 4 cutting edges per row for improved cutting quality through "pulling cut", longer service life and enormous noise reduction.	4639
Solid Steel Cutter Block for 335 20	With 6 rows of spiral knives, 22 rotatable and replaceable carbide inserts with 4 cutting edges per row for improved cutting quality through "pulling cut", longer service life and enormous noise reduction.	4640
Solid Steel Cutter Block for 336 20	With 6 rows of spiral knives, 27 rotatable and replaceable carbide inserts with 4 cutting edges per row for improved cutting quality through "pulling cut", longer service life and enormous noise reduction.	4472
Replacement Carbide Inserts for Spiral Cutters	10 pieces replacement carbide inserts, turnable and exchangeable, 15 x 15 x 2.5 mm, 30°, with 4 cutting edges	4641
Replacement Carbide Inserts for Spiral Cutters	162 pieces replacement carbide inserts, turnable and exchangeable, 15 x 15 x 2.5 mm, 30°, with 4 cutting edges for the complete cutter block.	4641.6
Service set for Spiral Cutter Blocks	Case with 1 litre resin dissolving concentrate, 1 cleaning brush each of steel and brass, 10 reversible carbide inserts (15 x 15 x 2.5 mm), incl. 5 screws (Torx M6 x 15 mm), 1 torque spanner and 2 bit inserts for assembly.	4647
Spare Screws for Spiral Cutter Block	10 pcs. spare screws (Torx M6 x 15 mm)	4642

16.2 Planer Guards

Article	Description	Art.-No.
Planer Guard SUVAMATIC for 334 20 and 335 20	With 2-piece fold-down cover and spring-loaded contact pressure.	3281
Planer Guard SUVAMATIC for 336 20	With 2-piece fold-down cover and spring-loaded contact pressure.	3285
Planer Guard TX MATIC for 334 20 and 335 20	With 2-piece fold-down cover and spring-loaded contact pressure with rollers.	3283
Planer Guard TX MATIC for 336 20	With 2-piece fold-down cover and spring-loaded contact pressure with rollers.	3284

16.3 Special Accessories

Article	Description	Art.-No.
Machine Socket	For the supply of additional components, e.g. a feed unit.	4005
Special Voltage	230 VAC / 50 Hz (max. 7,5 kW)	4601

	<p><i>Only use the accessories and spare parts specified by the manufacturer. The use of other accessories or spare parts may cause injury to persons and damage to the machine. The manufacturer accepts no liability for any damage resulting from the use of non-authorized accessories and spare parts or additional components from third parties!</i></p>
---	--

17 Disassembly and Scrapping

When dismantling and scrapping the machine, the current EU regulations or the respective regulations and laws of the country of operation, which are prescribed for proper dismantling and disposal, must be observed. The aim is to dismantle the machine and its various materials and components properly, to recycle all possible parts and to dispose of non-recyclable components in the most environmentally friendly way.

	<p>Please pay particular attention to</p> <ul style="list-style-type: none"> • <i>the dismantling of the machine in the working area</i> • <i>proper dismantling of the machine and accessories</i> • <i>a safe and proper removal of the machine</i> • <i>proper separation of all components and materials.</i>
---	--

When dismantling and disposing the machine, the laws and regulations in force at the place of use concerning health and environmental protection must be observed.

	<p>Remove all residues of oil, grease and other lubricants and have them disposed of properly by a qualified disposal company.</p>
---	---

When separating, disposing of or recycling the machine materials, comply with the environmental protection laws in force at the place of use regarding the disposal of industrial solid waste toxic and hazardous waste.

	<ul style="list-style-type: none"> • <i>Hoses and plastic parts as well as other components that are not made of metal must be dismantled and recycled or disposed of separately.</i> • <i>Electrical components such as cables, switches, connectors, transformers, etc. must be removed and (if possible) recycled or otherwise disposed of in a qualified manner.</i> • <i>Pneumatic and hydraulic parts such as valves, solenoid valves, pressure regulators, etc. must be removed and (if possible) recycled or otherwise disposed of in a qualified manner.</i> • <i>Dismantle the base frame and all metal parts of the machine and sort them according to material type. Metals can be melted down and recycled.</i>
--	--

In the event of improper disposal of lubricants, the following residual risks to the environment and health exist:

	<p>Pollution of the environment by seepage into groundwater or sewage system.</p>
---	--

	<p>Poisoning of the personnel contracted for the disposal.</p>
---	---

Note: The disposal of lubricants considered toxic and hazardous must be carried out in accordance with the regulations and laws in force at the respective place of use. Only qualified disposal companies that have the appropriate permits for the disposal of used oil and lubricants are to be commissioned with the disposal.

EU - Declaration of Conformity

in accordance with the EU Machinery Directive 2006/42/EC Annex II A

The manufacturer,

HOKUBEMA Maschinenbau GmbH
Graf-Stauffenberg-Kaserne
Binger Str. 28 | Halle 120
D- 72488 Sigmaringen (Germany)

Phone: +49 (0) 7571 / 755 - 0
Fax: +49 (0) 7571 / 755 - 222

hereby declares that the manufactured machine

Surface Planer & Jointer TYPE 334/20, 335/20 and 336/20

Machine-No.:

Year of manufacture:

in the version provided complies with the following directives:

- Machinery Directive 2006/42/EC
- EMC Directive 2014/30/EU

The notified body (0392)

DGUV Test

**Prüf- und Zertifizierungsstelle Holz
Fachbereich Holz und Metall
Vollmoellerstraße 11
70563 Stuttgart (Germany)**

has carried out an EC type-examination for the above machine.

Mr. Andreas Ganter, Graf-Stauffenberg-Kaserne, Binger Str. 28 | Halle 120,
72488 Sigmaringen (Germany), is authorised to compile the technical documentation.

Type Examination Certificate No.: HO 111004 from 28.01.2011

Sigmaringen, 15.02.2022
.....



.....
Reinhold Beck
Managing Director