

TRANSLATION OF THE ORIGINAL VERSION

PANHANS

QUALITÄT SEIT 1918

CE

Operating Manual

Sliding Table Saw PANHANS - 690|100



Machine Type: **Sliding Table Saw 690|100**

HOKUBEMA Maschinenbau GmbH

Graf-Stauffenberg-Kaserne, Binger Str. 28 | Halle 120

DE 72488 Sigmaringen | Tel. +49 07571 755-0

E-Mail: info@hokubema-panhans.de | Web: <https://hokubema-panhans.de>

Space for notes:

HOKUBEMA Maschinenbau GmbH

Graf-Stauffenberg-Kaserne
 Binger Straße 28 | Halle 120
 DE 72488 Sigmaringen
 Tel.: +49 (0)7571-755-0
 Fax: +49 (0)7571-755-222

Handover Certificate

Machine type:	
Machine no.:	
Construction year:	
Customer address (location of the machine):	
Name:	
Street:	
Postcode/City:	
Phone:	Fax:
E-mail:	
<p>Warranty: On the basis of our Terms and Conditions of Sale, Delivery and Payment of the respective current status, we assume a warranty of 12 months, calculated from the day of delivery, for material defects and defects of title in connection with the delivery for the above-mentioned machine.</p>	
<p>Warranty claims: Warranty claims on the part of HOKUBEMA Maschinenbau GmbH only exist if we have received the signed handover certificate and the machine has been properly commissioned. We therefore ask for immediate return.</p> <p>Important: Please read and follow the instructions in chapter ⇒ 1 "Liability and Warranty".</p>	
<p>Confirmation of the buyer:</p> <ul style="list-style-type: none"> ✓ The machine described above was purchased by me/us. ✓ Together with this handover certificate, I have received the operating manual valid for the machine (edition: _____). ✓ The operating instructions have been read and understood by me, as well as by all persons responsible for operating the specified machine. I will ensure that persons working on the machine at a later date are also instructed accordingly. 	
_____	_____
Name and position	Date

Signature of the customer	
Address of the dealer (company stamp):	The machine, including the operating manual, was handed over to the buyer and installed according to the specifications in the operating manual.

	Date

	Signature - Customer Service

Space for notes:

HOKUBEMA Maschinenbau GmbH

 Graf-Stauffenberg-Kaserne
 Binger Straße 28 | Halle 120
 DE 72488 Sigmaringen
 Tel.: +49 (0)7571-755-0
 Fax: +49 (0)7571-755-222

Handover Certificate

Machine type:	
Machine no.:	
Construction year:	
Customer address (location of the machine):	
Name:	
Street:	
Postcode/City:	
Phone:	Fax:
E-mail:	
Warranty: On the basis of our Terms and Conditions of Sale, Delivery and Payment of the respective current status, we assume a warranty of 12 months , calculated from the day of delivery, for material defects and defects of title in connection with the delivery for the above-mentioned machine.	
Warranty claims: Warranty claims on the part of HOKUBEMA Maschinenbau GmbH only exist if we have received the signed handover certificate and the machine has been properly commissioned. We therefore ask for immediate return.	
Important: Please read and follow the instructions in chapter ⇒ 1 " Liability and Warranty ".	
Confirmation of the buyer: <input checked="" type="checkbox"/> The machine described above was purchased by me/us. <input checked="" type="checkbox"/> Together with this handover certificate, I have received the operating manual valid for the machine (edition: _____). <input checked="" type="checkbox"/> The operating instructions have been read and understood by me, as well as by all persons responsible for operating the specified machine. I will ensure that persons working on the machine at a later date are also instructed accordingly.	
_____	_____
Name and position	Date

Signature of the customer	
Address of the dealer (company stamp):	The machine, including the operating manual, was handed over to the buyer and installed according to the specifications in the operating manual.

	Date

	Signature - Customer Service

Table of Contents

1	Liability and Warranty	12
2	Introduction.....	13
2.1	Legal Notice	13
2.2	Illustrations	13
3	Symbols	13
3.1	General Symbols	13
3.2	Symbols in Safety Instructions	14
4	General	15
4.1	Intended Use.....	15
4.2	Target Group and Previous Experience.....	15
4.3	Requirements for the Operators.....	15
4.4	Accident Prevention.....	16
4.5	General Safety Regulations	16
4.6	Structure and Function	17
4.7	Standard Equipment	17
4.8	Special Equipment	18
4.9	Expandability.....	18
5	Safety.....	19
5.1	Basic Safety Instructions	19
5.1.1	Application Area and Intended Use	19
5.1.2	Modifications and Conversions to the Machine	19
5.1.3	Residual Risks	20
5.1.4	Observe the Environmental Protection Regulations.....	21
5.1.5	Organisational Measures.....	22
5.1.6	Personnel Selection and Qualification - Basic Duties.....	22
5.2	Safety Instructions for Specific Phases of Operation	22
5.2.1	Normal Operation	22
5.2.2	Special work within the Scope of Maintenance Work as well as Troubleshooting in the Workflow.....	23
5.3	Safe Working Practices	23
5.4	Hazardous Areas on the Sliding Table Saw	25
5.4.1	Danger Zone Saw Blade	25
5.4.2	Danger Zones around the Machine	25
5.5	Avoidance of Kickback Hazards.....	26
5.5.1	Use fence and saw blade guard	26
5.5.2	Never work without the riving knife.....	26
5.5.3	Rip fence when cutting short workpieces to width	26
5.5.4	Parallelism of the rip fence.....	27
5.5.5	Cutting off small pieces on the rip fence	27
5.6	Special Characteristics of Guards Made of Polycarbonate (Plexiglas)	28
5.6.1	Effect of cooling lubricants on polycarbonate	28
6	Machine Data	28

6.1	Technical Specifications	28
6.2	Technical Characteristics.....	29
6.3	Emission Levels	30
6.3.1	Noise Emission Values:	30
7	Dimensions	31
7.1	Working Areas.....	31
7.2	Dimensions (Front View).....	31
7.3	Dimensions (Top View)	32
8	Installation and Connection	33
8.1	Check Delivery Conditions	33
8.2	Transport to the Installation Site	33
8.3	Levelling with a Spirit Level.....	34
8.3.1	Procedure in the Normal Case.....	34
8.3.2	Procedure in the Exceptional Case	34
8.4	Lashing on a Transport Vehicle	35
8.5	Temporary Storage	35
8.6	Connecting the Extraction Unit.....	36
8.7	Electrical Connection	37
8.7.1	Back-up Fuses (On-site)	37
9	Components & Controls	38
10	Mounting and Usage	40
10.1	Slide Table.....	40
10.2	Rip Fence.....	40
10.2.1	Operating the Rip Fence	41
10.3	Mounting the Cross Slide	42
10.3.1	Moving the Cross Slide	42
10.4	Swivelling Saw Blade Guard	43
10.5	Change Saw Blade Guard	43
11	Commissioning	44
11.1	Control Elements	44
11.2	Switching ON.....	44
11.3	Switching OFF.....	44
11.4	Safety Equipment.....	45
11.4.1	Saw Blade Guard with Extraction	45
11.4.2	Safety Switches.....	45
11.4.3	Emergency Stop Switches.....	45
12	Operating the Cross-Cut Fence	46
12.1	Setting Lengths > 1885 mm.....	46
12.2	Readjusting the Fence Rulers.....	46
12.3	Cross-Cut Fence Accessories and Options	46
13	Operating the 4.7" Touch Display	47
13.1	Start Screen.....	47

13.2	Status Window	47
13.3	Language Settings	48
13.4	Machine Overview	48
13.5	Saw Blade Calibration	48
13.5.1	Calibrate Height	49
13.5.2	Calibrate Angle	50
13.6	Date and Time (from software version 1.9)	51
14	Speed Setting	51
15	Changing the Saw Blade	52
15.1	Remove Saw Blade	52
15.2	Insert Main Saw Blade	53
15.3	Riving Knife Setting	53
16	Optional Components	54
16.1	Tele-Digit Cross-Cut Fence	54
16.1.1	Features	54
16.1.2	Installation	54
16.1.3	Tele-Digit Components	55
16.1.4	Digital Indicator	55
16.1.5	Length Measurement Switching	55
16.1.6	Calibrate Tele-Digit	55
16.1.7	Battery Change	56
16.1.8	Set & Change Reference Dimensions	56
16.1.9	Sleep-Mode	57
16.1.10	Fix Error Message "FULL"	57
16.2	Rip Fence left to the Saw Blade	58
16.3	Double-sided Mitre Fences DSG-A and DSG-D	58
16.4	Cross-Cut & Mitre Fence Super Gehrfix I	59
16.4.1	Features	59
16.4.2	Super Gehrfix I Operation	60
16.4.3	Attach Cross-Cut Fence	60
16.4.4	Set Length > 1885 mm	60
16.4.5	Set Angle to 90 Degrees	60
16.4.6	Setting Degrees & Intermediate Degrees	61
16.5	Cross-Cut & Mitre Fence Super Gehrfix II	61
16.5.1	Features	61
16.5.2	Components & Overview	62
16.5.3	Calibrate Super Gehrfix II	62
16.5.4	Attach Cross-Cut Fence	62
16.5.5	Set Length > 1885 mm	62
16.5.6	Set Angle to 90 Degrees	62
16.5.7	Setting Degrees & Intermediate Degrees	63
16.5.8	Changing Parameters of the Digital Indicator	63
16.6	Auxiliary Mitre Fence for Super Gehrfix	64
16.6.1	Operating the Auxiliary Mitre Fence	64

16.7	Standard Mitre Fence	64
16.8	Digit PAB - Absolute Measuring System for the Rip Fence	65
16.8.1	Digit-PAB Features.....	65
16.8.2	Digit PAB - Operation.....	65
16.8.3	Digit PAB – Rip Fence Capacities.....	65
16.9	Power Feeder 76	66
16.9.1	Mounting the Power Feeder	66
16.10	Adjustable Scoring Saw Blade “QuickStep”.....	67
16.10.1	Setting the scoring width.....	67
16.10.2	Changing the Scoring Saw Blade.....	67
16.11	Manual Scoring Unit 1750.....	69
16.11.1	Adjusting the manual scoring saw	70
16.12	Spraying System	70
16.12.1	Special features when using a spraying system	70
16.13	Laser Cut-Position Indicator.....	71
16.14	Trimming with Laser Beam	71
16.15	Special Requirements for Use	71
16.16	Swivel-Away Device for the Cross Slide	72
16.16.1	Attaching the swivel arm to the cross slide	72
16.16.2	Reattaching the Cross Slide	72
17	Troubleshooting	73
17.1	Fault Messages on the Touchscreen	74
17.2	Retightening / Changing the V-belt.....	75
18	Maintenance and Inspection.....	76
18.1	Lubrication Guide.....	76
19	Options and Accessories	77
19.1	Sawing Units	77
19.2	Machine Operation	77
19.3	Optional Fence Systems.....	77
19.4	Slide Table and additional Supports.....	79
19.5	Support Systems	79
19.6	Special Accessories	80
20	Disassembly and Scrapping	81
	EU - Declaration of Conformity	82

List of Figures

Figure 1: Saw blade.....	13
Figure 2: Danger zone saw blade.....	25
Figure 3: Danger zones around the machine.....	25
Figure 4: Cutting short workpieces to width.....	26
Figure 5: Fixing the deflector wedge on the table.....	27
Figure 6: Nameplate.....	28
Figure 7: Working areas.....	31
Figure 8: Dimensions (front view).....	31
Figure 9: Dimensions (top view).....	32
Figure 10: Machine transport.....	33
Figure 11: Levelling screws at the rear (normal case).....	34
Figure 12: Front levelling screws (exceptional case).....	34
Figure 13: Lashing points (4 x).....	35
Figure 14: Upper suction nozzle diameter.....	36
Figure 15: Lower suction nozzle diameter.....	36
Figure 16: Electrical connection.....	37
Figure 17: Components & controls - front view.....	38
Figure 18: Components & controls - top view.....	39
Figure 19: Slide table controls.....	40
Figure 20: Rip fence.....	40
Figure 21: Fitting the rip fence.....	41
Figure 22: Operating the rip fence.....	41
Figure 23: Cross slide mounting.....	42
Figure 24: Cross slide clamping.....	42
Figure 25: Moving the cross slide.....	42
Figure 26: Swivel arm for saw blade guard.....	43
Figure 27: Fitting the saw blade guard.....	43
Figure 28: Control elements.....	44
Figure 29: Flip stop with measuring scale and magnifying glass.....	46
Figure 30: Cross-cut fence operating elements.....	46
Figure 31: Fixing screw.....	46
Figure 32: Start screen.....	47
Figure 33: Status window.....	47
Figure 34: Language settings.....	48
Figure 35: Machine overview - current positions and speed.....	48
Figure 36: Saw blade height 50 mm.....	49
Figure 37: Calibrate height.....	49
Figure 38: Adopt calibration value for height.....	49
Figure 39: Angular gap.....	50
Figure 40: Calibrate angle.....	50
Figure 41: Adopt calibration value for angle.....	50
Figure 42: Set date and time.....	51
Figure 43: Speed setting - loosen V-belt.....	51
Figure 44: Speed scheme.....	51
Figure 45: Remote locking on the slide table.....	52
Figure 46: Safety catch on the slide table.....	52
Figure 47: Fold sawdust flap forwards.....	52
Figure 48: Saw blade flange.....	52
Figure 49: Riving knife setting (symbolic representation).....	53
Figure 50: Tele-Digit cross-cut fence.....	54
Figure 51: Fixing points on the cross slide.....	54
Figure 52: Tele-Digit components.....	55
Figure 53: Digital indicator.....	55
Figure 54: Error message FULL.....	57
Figure 55: Rip fence mounted to the left of the saw blade.....	58
Figure 56: Flip stop (left to the saw blade).....	58
Figure 57: DSG-A (analogue).....	58
Figure 58: DSG-D (with digital indicator).....	58
Figure 59: Super Gehrfix I.....	59
Figure 60: Super Gehrfix I overview.....	60

Figure 61: Attach cross-cut fence	60
Figure 62: Super Gehrfix II	61
Figure 63: Super Gehrfix I overview	62
Figure 64: Auxiliary mitre fence	64
Figure 65: Operating the auxiliary mitre fence	64
Figure 66: Standard mitre fence	64
Figure 67: Digit PAB	65
Figure 68: Rip fence with Digit-PAB	65
Figure 69: Power feeder 76	66
Figure 70: Mounting the power feeder	66
Figure 71: Quickstep setting mechanism for scoring saw blade	67
Figure 72: Quickstep quick-release screw	68
Figure 73: Saw blade flange of the scoring saw	69
Figure 74: Safety catch of the sawdust flap	69
Figure 75: Setting wheels for scoring saw	70
Figure 76: Laser cut-position indicator	71
Figure 77: Trimming with laser beam	71
Figure 78: Position and mount swivel arm	72
Figure 79: Swivel away cross slide	72
Figure 80: Final parking position	72
Figure 81: Error message 1	74
Figure 82: Error message 2	74
Figure 83: Error message 3	74
Figure 84: Error message 4	74
Figure 85: Error message 5	74
Figure 86: Error message 6	74
Figure 87: Error message 7	74
Figure 88: V-belt tightness	75
Figure 89: Lubrication points on the height adjustment	76

Revisions

Revision	Editor	Modification	Date
1	AG	Original document translated	07.03.2022
2	AG	Minor corrections made and section 10.4 adapted	08.09.2023

1 Liability and Warranty

When purchasing a machine or additional component (hereinafter referred to as “machine”), the General Terms and Conditions of Sale and Delivery of HOKUBEMA Maschinenbau GmbH generally apply. These are provided to the purchaser or operator at the latest when the contract is concluded.



IMPORTANT NOTE: Liability and warranty claims shall only commence from the point in time at which the signed handover certificate (see ⇒ page 3 resp. 5) from the dealer and/or end customer for the delivered machine has been submitted to HOKUBEMA Maschinenbau GmbH in written form.

Liability and warranty claims for personal injury and property damage are generally excluded if they are due to one or more of the following causes:

- Commissioning of the machine without prior machine instruction by an authorised and adequately trained specialist who is familiar with the function and dangers of the machine.
- Electrical connection as well as repair and/or maintenance work on electrical components by personnel who do not have the appropriate qualifications.
- Connection and repair and/or maintenance work on hydraulic or pneumatic components by personnel who do not have the appropriate qualifications.
- Non-observance of the instructions in the operating manual, in particular the chapter “Safety”.
- Improper use or operation in an unauthorised area of application.
- Improper assembly, commissioning, operation and maintenance of the machine.
- Unauthorised conversions or modifications to the machine or additional components.
- Operating the machine without using all the protective equipment available for the operation.
- Inadequate monitoring and maintenance of the machine components and protective devices.
- Continuing to operate the machine when faults, damage or defects are present.
- Processing materials that do not correspond to the machine's area of application.
- Carrying out operations that are not permitted for the machine supplied.
- Use of tools that are not permitted for the machine supplied.
- Operating the machine outdoors or in damp, wet or potentially explosive environments.
- Operation of the machine outside permissible ambient temperatures or humidity.
- Grossly negligent behaviour when handling or operating the machine.
- Impact by foreign bodies, e.g. stones, metal parts, etc.
- Improperly carried out repairs.
- Catastrophic events due to force majeure.

2 Introduction

This operating manual applies exclusively to the PANHANS sliding table saw type 690|100. The purpose of this document is to acquaint the user with the machine and enable him to use it to the full extent of its intended capabilities. Additionally it contains important information to operate the machine safely, properly and economically. Observance of the manual helps to avoid hazards, reduce repair costs and downtimes and increase the reliability and service life of the machine.

Furthermore, this operating manual serves to supplement instructions based on national regulations for accident prevention and environmental protection.



Figure 1: Saw blade

Apart from the operating manual and the legally binding accident prevention provisions applicable in the country and place of use, the recognized technical regulations for safe and proper work must also be observed.

	<p><i>This operating manual must always be available at the place of use of the machine. It must be read and followed by every person who is assigned to work on the machine, e.g.</i></p> <ul style="list-style-type: none"> • <i>during operation, including set-up, troubleshooting in the work process, removal of production waste and maintenance,</i> • <i>during maintenance (servicing, inspection, repair)</i> • <i>and/or during transport.)</i>
---	---

2.1 Legal Notice



All contents of these operating instructions are subject to the rights of use and copyright of Hokubema Maschinenbau GmbH. Any reproduction, modification, further use and publication in other electronic or printed media, as well as their online publication, requires the prior written consent of Hokubema Maschinenbau GmbH.

2.2 Illustrations















All photos, figures and graphics contained in this document are for illustration and better understanding only and may differ from the current state of the product.

3 Symbols

3.1 General Symbols

Symbol	Meaning
	Indicates passages within this operating manual that must be particularly observed in order to prevent malfunctions or damage to the machine.
	Refers to chapters, sections, or figures within this document.
	Refers to an external document or a third-party source.

3.2 Symbols in Safety Instructions

Symbol	Safety Instruction
	General danger symbol, which requires the highest attention! <i>Failure to observe may result in damage to the equipment, serious injury or even death.</i>
	Warning of possible danger from forklift traffic! <i>Non-observance may result in life-threatening injuries.</i>
	Warning indicates a possible hazard under suspended loads! <i>Non-observance may result in life-threatening injuries.</i>
	Warning indicates a possible fall hazard! <i>Non-observance of these instructions may result in serious injuries.</i>
	Warning indicates a possible cutting hazard! <i>Risk of personal injury and possibly additional damage to equipment.</i>
	Reference to the obligation to wear protective gloves! <i>Non-observance of these instructions may result in personal injury.</i>
	Reference to the obligation to wear hearing protection! <i>Non-observance of these instructions may result in personal injury.</i>
	Reference to the obligation to wear protective goggles! <i>Non-observance of these instructions may result in personal injury.</i>
	Reference to the obligation to wear a respiratory protection mask! <i>Non-observance of these instructions may cause breathing difficulties and lung damage.</i>
	Reference to the obligation to wear safety shoes! <i>Non-observance of these instructions may result in personal injury.</i>
	Possible dangerous crushing hazard in the area of stationary objects! <i>Risk of personal injury and possibly additional equipment damage.</i>
	Reference to a possible crushing hazard! <i>Non-observance increases the risk of injury to hands and fingers!</i>
	This symbol warns of the dangers of electric voltage! <i>Failure to observe may result in damage to the equipment, serious injury or even death.</i>
	Fire hazard! Do not smoke and do not ignite open fire.
	Access for unauthorized persons prohibited! <i>Risk of personal injury and possibly additional equipment damage.</i>
	This safety notice indicates a possible dangerous pull-in hazard! Wearing loose clothing, jewellery as well as long untied hair is prohibited! <i>Risk of personal injury and possibly additional damage to property.</i>

4 General

This sliding table saw was produced by HOKUBEMA Maschinenbau GmbH according to the current state of the art and placed on the market as a complete machine. All legal and normative regulations were observed.

All measuring scales are manufactured in accordance with the calibration regulations to accuracy class 2.

4.1 Intended Use

The PANHANS - 690|100 sliding table saw is designed for cutting materials for which the respective saw blade used is suitable (e.g. wood, pressboard, veneer, plastic or aluminium). This machine is not suitable for cutting metal, plastic or scrap wood (which could contain nails, screws and other metal parts). The machine may only be operated on a firm, level surface with a minimum load-bearing capacity of 1,000 kg/m².



Improper use can lead to danger to persons and to a defect or damage to the machine.

4.2 Target Group and Previous Experience

This operating manual is intended for the operating and maintenance personnel of the machine. The operating personnel is to be determined by the operator and must further meet the following requirements:

- Basic technical knowledge (e.g. apprenticeship as carpenter, machine fitter, etc. and/or practice in operating sliding table saws resp. woodworking machines)
- Reading and understanding these operating and maintenance instructions

In order to acquire the knowledge required to operate this machine, the operator must ensure the following measures:

- Product training for every operator (also possible external personnel)
- Regular safety instruction

4.3 Requirements for the Operators

- The sliding table saw may only be operated by trained personnel who have also read this manual.
- Inspection, maintenance, cleaning and repair may only be performed by technical specialists with product-specific training and mechanical and/or electrical training.
- Specialists with product-specific training are to be commissioned and held responsible for planning and checking the work.
- The national protective regulations for employees must be observed.
- The operator is responsible for the safe use of the machine.
- The legal minimum age must be observed.

4.4 Accident Prevention

To avoid accidents, the following rules must be observed for operation:

- Prevent unauthorized persons from gaining access to the machine.
- Keep unauthorized persons away from the danger areas.
- Repeatedly inform present other persons about existing residual risks (see section ⇒ 5.1.3).
- Conduct and record regular training & instruction for persons who must be in the area of the machine.
- New employees must be trained internally to work on a thickener and this training must be documented.

4.5 General Safety Regulations

In general, the following safety regulations and obligations apply when handling the machine:

- A sliding table saw may only be operated in a technically perfect and clean condition.
- It is prohibited to remove, modify or bypass any protective, safety or monitoring equipment.
- It is forbidden to modify or alter the machine without the written approval of the manufacturer / supplier.
- Faults or damage must be reported to the operator immediately, eliminated without delay and repaired if necessary.
- For repairs, only original spare parts may be used.
- All protective, safety and monitoring devices must be regularly checked and maintained by the operator.
- Only instructed, trained or qualified persons may work on this machine.
- Maintenance work must be carried out and documented in accordance with the maintenance instructions.
- After maintenance or repair, the machine may only be started with all protective devices fitted. A responsible person must be defined for this purpose, who checks that the guards have been properly installed.

For the operation of a sliding table saw, the respective national safety regulations for employees as well as the national safety and accident prevention regulations apply.

4.6 Structure and Function

- PANHANS - 690|100 - Sliding table saw with tiltable saw blade 0 ... 46°
- Slide table length / cutting length: 3200 mm
- Cutting width at rip fence: 1030 mm
- Cutting height at 90°: max. 155 mm
- Cutting height at 46°: max. 105 mm

The machine table has a work surface of 685 mm x 1200 mm.

The drive is provided by a three-phase motor. The speed adjustment is done by V-belt changeover. The speeds are displayed in the touchscreen positioning control.

The circular saw shaft (30 mm \varnothing) accepts a saw blade up to \varnothing 450 mm.

The height and tilt adjustment of the circular saw blade is motorised in inching mode by means of pushbuttons, whereby the current positions can be read on the touch display. The double sliding table made of special aluminium profiles runs on wear-resistant guideways. The cross slide is hooked onto the slide table and supported by a strong telescopic swivel arm. The cross cut fence has continuous scales and an adjustable slide. It can be extended to 3200 mm and can be used on both sides of the cross slide.

The rip fence with a quick clamp can be adjusted to any dimension up to 1030 mm.

The main switch is lockable. The motor brake and the star-delta start-up are controlled via a contactor circuit.

4.7 Standard Equipment

- Saw motor with 5.5 kW (7.5 HP)
- 4 speeds with saw blade \varnothing 450 mm, cutting height 155 mm and saw blade guard
- Cross cut fence on cross slide with mm scale and telescopic pull-out extendable up to 3200 mm; with 2 pieces of robust and backlash-free sliding flip stops
- Cross cut fence can be used on both sides as angular mitre fence up to 46°
- Table widening 1200 x 600 mm
- Table extension 750 x 655 mm
- Manually adjustable rip fence with cutting width up to 1030 mm
- Electronic, wear-free motor brake
- Saw blade guard with interchangeable wide/narrow insert
- Cross slide with support roller on the outer narrow side
- Operation via control panel with 4.7" touchscreen display (height and tilt adjustment of the saw unit and speed)
- APA saw blade quick clamping system
- Saw blade \varnothing 400 mm retractable under the table top
- Suction nozzle \varnothing 120 mm on machine body, \varnothing 80 mm on saw blade guard
- Push-button control with electronic soft start for start and stop
- Riving knife 250 ... 450 mm, width = 2.5 (Art. No. 0001.0864)
- Open-end spanner SW 17 (Art. No. 0746.0992)
- Wooden push stick type 2391 (Art. No. 3416)
- Allen spanner SW 4 (Art. No. 0345.0741)
- Push handle 2390 (Art. No. 3328)
- Grease gun (Art. No. 0345.0132)
- CE conform and GS tested

4.8 Special Equipment

A wide range of special accessories and optional components are available for the sliding table saw type 690|100. These allow you to expand your machine individually.

Detailed information and the corresponding article numbers can be found in chapter ⇨ 19.

4.9 Expandability

The machine is prepared for the later addition of special accessories from the extensive manufacturer portfolio. If you would like to retrofit your machine, please request documentation from us about the accessories you require.

Please indicate the following data:

Type

Machine No.

Voltage (V)

Motor Power (kW)

Year of manufacture

(see nameplate on the machine)

5 Safety

5.1 Basic Safety Instructions

Woodworking machines can be dangerous if used improperly. Therefore, observe the safety instructions listed in this chapter and the accident prevention regulations of your employer's liability insurance association!

	<i>The manufacturer accepts no liability for damage and malfunctions resulting from failure to observe these operating instructions.</i>
---	---

5.1.1 Application Area and Intended Use

	<p><i>The PANHANS 690 100 sliding table saw is used exclusively for cutting materials for which the saw blade used is suitable (e.g. wood, chipboard, veneer, plastic and aluminium).</i></p> <p><i>This sliding table saw is not suitable for cutting metal, plastic or scrap wood (which may contain nails, screws etc.).</i></p> <p><i>The machine may only be operated on a firm, level surface with a minimum load-bearing capacity of 1,000 kg/m².</i></p>
---	--

Any processing of other materials requires prior consultation with and approval of the manufacturer.

Only one-piece (CV) or compound (HM) circular saw blades (according to EN 847-1) with the following dimensions are permissible as tools:

<i>Saw blade</i>	<i>min.</i>	<i>max.</i>
Main saw blade	Ø 250 mm	Ø 450 mm
Scoring saw blade	-	Ø 125 mm

Minimum saw blade thickness:

Main saw blade: 2.2 mm

Scoring saw blade: 3.6 mm

The machine is not suitable for operation outdoors or in potentially explosive areas.

- Permissible ambient temperature: +5 ... +40° C.
- Permissible humidity: 30 ... 90 %.

Intended use also includes the connection of the machine to an adequately dimensioned extraction system and compliance with the operating, maintenance and servicing conditions specified in the operating manual.

Any other use is not in accordance with the intended use and is therefore prohibited.





















5.1.2 Modifications and Conversions to the Machine

















	<i>Unauthorised conversions and modifications to the machine are strictly prohibited for safety reasons. This will invalidate the CE declaration of conformity! The manufacturer is not liable for any resulting damage. The risk for this is borne exclusively by the operator/user.</i>
---	--

5.1.3 Residual Risks

The machine is built according to the latest state of the art and the recognised safety rules. Nevertheless, the use of the machine may cause danger to life and limb of the user or third parties or damage to the machine and other equipment.

Due to the construction of the machine, the following residual risks can occur even when used as intended and despite compliance with all relevant safety regulations:

	Reading and applying the operating manual is mandatory for the operating personnel.
	Be alert to possible crushing hazards: a) when transporting the machine by forklift truck → between forks & pallet / machine b) when picking up the machine → between machine / pallet and floor c) when lowering the machine → between machine and fixed equipment
	Be alert to possible crushing hazards when lowering the machine (from the cargo pallet to the floor) with a forklift truck or overhead crane.
	Make sure that no objects fall from the forklift truck / crane. Do not leave any objects / tools on the machine.
	It is strictly prohibited to ride on the machine during a lifting operation (with the indoor crane or forklift). There is a danger of falling!
	Unauthorised persons are not allowed to enter the installation area of the machine (responsibility of the operator).
	Be aware of the danger of cutting at the saw blade. Never reach into the running saw blade! Always wear protective gloves when changing a saw blade.
	The saw blade guard must be used resp. moved over the saw blade during every cutting operation. Cutting without using the saw blade guard is strictly prohibited. The wearing of protective goggles is mandatory.
	Be aware of the danger from falling objects such as workpieces, tools or similar. Therefore, wear safety shoes, especially when transporting and setting down the machine.
	Be aware of the risk of injury from flying tool parts in the event of tool breakage. Therefore wear protective goggles.
	Be aware of the risk of injury from flying workpiece parts and chips, splinters and dust coming out of the machine. Therefore wear protective goggles.
	Be aware of the increased noise emission and wear hearing protection.
	Be aware of the increased dust generation. Use the extraction device and wear a dust mask if necessary.
	Be aware of a possible danger of being drawn in by moving machine parts or tools. This can cause pieces of clothing or hair to be caught. Always wear tight-fitting clothing or avoid loose clothing and wear a hair net if necessary.
	Danger of being drawn in and increased risk of injury when wearing watches and jewellery. Wearing watches and jewellery is prohibited on the tilting spindle moulder.
	Never reach into the area between the saw blade guard and the aluminium profile rail (cross-cut fence). There is a danger of crushing!
	Electrical equipment must be maintained and cleaned regularly.
	The saw blade guard for mitre cutting (inclined saw blade) is wider and can therefore be reached earlier by the profile rail. Therefore the danger of splintering exists earlier.
	Danger from electric shock! It is strictly forbidden to bypass safety devices (e.g. safety switches).
	Danger from electric shock! There are hazards when working on the electrical system. This work must only be carried out by qualified personnel!
	Be aware of the crushing hazard when closing the saw blade guard and the cutting hazard at the saw blade.

	Be aware of the risk of crushing between the slide table and the holding block for the saw blade.
	Be aware of the risk of crushing at the end of the running rail for the slide table between the running rail and the slide table.
	Pay attention to the risk of crushing on the inside of the slide table on fixed components / guide rail (2x) on the inside of the slide table.
	Be aware of the risk of crushing when pushing the slide table forward between the slide table and the front holding block for the saw blade.
	Do not stand between the cross-cut fence and the telescopic swivel arm (when pushing the slide table forwards or backwards). There is a danger of crushing (it is forbidden for the operator and third persons to stay in this area).
	Pay attention to the danger of crushing in the area of the support for the cross slide (at the swivel arm). Reaching into this area is prohibited!
	Do not reach into the area between the rip fence and the ruler bar (especially when pushing back the rip fence).
	Pay attention to the danger of cutting and crushing in the area of the scoring saw blade. Access during normal operation and by unauthorised persons is strictly prohibited.
	Make sure that you do not reach into the area of the rotation angle limiters on the underside of the upper guide arm for the saw blade guard. There is a risk of crushing there.
	Make sure that no unauthorised persons are in the area of the machine.
	Be aware of the risk of crushing between the sliding cross-cut fence and the cross slide on both sides: Do not reach into these areas!
	Before telescoping the cross-cut fence, make sure that the main element is fixed in place using the two black star wheels.
	Be aware of the danger of crushing between the telescopic extendable part of the cross-cut fence and the end piece of the scale.
	The emergency stop buttons must always be freely accessible. They must not be moved, e.g. with hopper boxes. Check the function of the emergency stop buttons daily (before starting work).
	Laser warning: The machine can be optionally equipped with a laser pointer for the cut position. Looking directly into the laser beam will cause serious eye injury!
	Fire hazard due to wood dust in connection with flying sparks and/or open fire!

5.1.4 Observe the Environmental Protection Regulations

During all work with the machine, the environmental protection regulations, obligations and laws for waste avoidance and proper recycling and/or disposal applicable at the place of use must be observed. This applies in particular to installation, repair and maintenance work involving substances that could pollute the groundwater (e.g. hydraulic oils and cleaning agents and liquids containing solvents). In any case, prevent them from seeping into the ground or entering the sewage system.

	<p>Store and transport the above-mentioned hazardous substances only in suitable containers. Avoid leakage of hazardous substances by using suitable collection containers. Ensure that the above-mentioned substances are disposed of by a qualified disposal company.</p>
---	--

5.1.5 Organisational Measures

- ⚠ Always keep this operating manual within easy reach and at the place of use of the machine.
- ⚠ In addition to the operating manual, observe and instruct on generally applicable legal and other binding regulations for accident prevention and environmental protection.
- ⚠ Supplement the operating manual with further instructions, including supervisory and reporting duties, to take account of special operational features (e.g. with regard to work organisation, work processes, personnel employed).
- ⚠ Operators must not wear open long hair, loose clothing or jewellery (including rings). There is a risk of injury, e.g. by getting caught or drawn in.
- ⚠ Observe the safety instructions and danger warnings on the machine and keep them complete and in legible condition.
- ⚠ In case of safety-relevant changes to the machine or its operating behaviour, shut down the entire system immediately and report the fault to the responsible office/person.
- ⚠ Spare parts must meet the technical requirements specified by the manufacturer. The exclusive use of original spare parts ensures this. Therefore, only use original spare parts from the manufacturer.
- ⚠ Observe the fire alarm and firefighting possibilities. Make the location and operation of fire extinguishers (fire class ABC) known. Do not use water!

5.1.6 Personnel Selection and Qualification - Basic Duties

- ⚠ The machine design and operation is intended for right-handers.
- ⚠ Work on and with the machine may only be carried out by reliable personnel. Observe the legal minimum age!
- ⚠ Only use trained or instructed personnel. Clearly define the responsibilities of the personnel for operating, setting up, maintaining and repairing!
- ⚠ Ensure that only authorised personnel work on the machine!
- ⚠ If personnel to be trained or apprenticed have to work on the machine, this may only be done under the constant supervision of an experienced resp. qualified person.
- ⚠ Work on the electrical equipment of the machine may only be carried out by a qualified electrician or by untrained persons under the direction and supervision of a qualified electrician in accordance with the electrotechnical regulations.

5.2 Safety Instructions for Specific Phases of Operation

5.2.1 Normal Operation

- ⚠ Refrain from any working method that could compromise safety!
- ⚠ Take measures to ensure that the machine can only be operated in a safe and functional condition.
- ⚠ The machine may only be operated when all protective devices and safety-related equipment, such as e.g.
 - Detachable safety devices
 - Emergency stop system
 - Sound insulation
 - Extraction unit
 are present and functional.
- ⚠ Check the machine at least once per shift for externally visible damage and defects!
- ⚠ Report any changes that have occurred (including changes in operating behaviour) immediately to the responsible office or person! If necessary, stop the machine immediately and secure it!
- ⚠ Adjust the cutting angle and cutting height only when the saw blade is stationary.
- ⚠ An obstacle-free working area around the machine is essential for safe operation.
- ⚠ The floor should be level, well maintained and free of debris such as chips and cut workpieces.
- ⚠ The workplace should be adequately lit by general or local lighting.
- ⚠ Never try to remove cuttings, chips or other parts from the cutting area while the machine is running!
- ⚠ Inspect the workpiece for foreign inclusions, knots, twists and other irregularities.

- ⚠ Switch off the machine even during short work interruptions!
- ⚠ Switch off the control voltage and main switch before leaving the machine. Never leave the machine unattended in an unsecured state.

5.2.2 Special work within the Scope of Maintenance Work as well as Troubleshooting in the Workflow

- ⚠ Observe maintenance and inspection activities prescribed in the operating manual!
- ⚠ These activities, as well as all other repair work, may only be carried out by qualified personnel!
- ⚠ For all work concerning operation, production adjustment, conversion or setting of the machine and its safety-related equipment as well as maintenance and repair, observe switch-on and switch-off procedures according to the operating manual and instructions for maintenance work!
- ⚠ Secure the machine against unexpected restarting during maintenance and repair work.
 - ➔ Lock the main switch with a padlock!
- ⚠ Always tighten screw connections that have been loosened during maintenance and repair work!
- ⚠ If it is necessary to dismantle safety equipment during set-up, maintenance and repair, the safety equipment must be reassembled and checked immediately after completion of the maintenance and repair work!
- ⚠ Ensure safe and environmentally friendly disposal of operating and auxiliary materials (e.g. oils) and replacement parts (e.g. electronic components).!

5.3 Safe Working Practices

- Whenever possible, a push stick must be used to prevent working with the hands close to the saw blade. Observe the danger zone of 120 mm around the saw blade. See also section ⇒ 5.4 “Hazardous Areas on the Sliding Table Saw”.
- Always work with all available guards and protective devices! These must be accessible at the right places and in perfect working order.
- Working position: Always to the side of the saw blade, outside a possible kickback area (= area directly in front of the saw blade). See also section ⇒ 5.4 “Hazardous Areas on the Sliding Table Saw”.
- Do not start cutting until the saw blade has reached full speed.
- Set the distance between the saw blade and riving knife to 3 - 8 mm as evenly as possible.
- The riving knife must not be thicker than the kerf width and not thinner than the saw blade body.
- Only use saw blades suitable for the respective operation.
- Do never use damaged saw blades.
- A detachable feeding unit should be used whenever possible. This must be equipped with a separate on/off switch.
- A removable feeding unit is not a substitute for the riving knife. The riving knife must always remain installed.
- When using a feeding unit, there must be sufficient space on the removal side in front of stationary obstacles (danger of crushing by the workpiece!).
- The use of the sliding table saw for cutting rebates, tenons or grooves is prohibited unless the part of the saw blade above the table is effectively secured.
- For “insert cutting”, suitable anti-kickback devices must be fitted. The riving knife has to be removed and the holder has to be fixed.
- The saw blade guard must be positioned above the saw blade and rest on the workpiece. The saw blade is then raised by the workpiece to the correct height, the cut is made and the saw blade is lowered again before the workpiece is removed.
- When cutting concealed, use aids such as an auxiliary fence and a push handle.
- The riving knife must not be removed during “concealed cutting” and “grooving”.
- If a second person is working at the sliding table saw to remove processed workpieces, this person must not stand at any other place than at the end of the table extension.

- Use a ram plate on the slide table when “trimming”.
- Use an aluminium profile rail with a narrow contact edge for cutting narrow and low batten.
- For cross-cuts use a cross-cut table with cross-cut fence.
- Use a deflector wedge to cut battens to length.
- Damaged table inserts must be replaced with new ones.
- When cutting narrow workpieces, use the push stick.
- Repairs may only be carried out by qualified personnel with the main switch locked.
- The machine must be connected to an effective extraction unit with a minimum flow rate of 20 m/s.
- The machine is equipped with an electric magnetic brake. If this brake no longer brakes within the prescribed braking time (10 s) despite readjustment, the customer service must be informed.

5.4 Hazardous Areas on the Sliding Table Saw

	Carry out adjustment work within the danger zones only when the saw blade is stationary!
---	---

5.4.1 Danger Zone Saw Blade

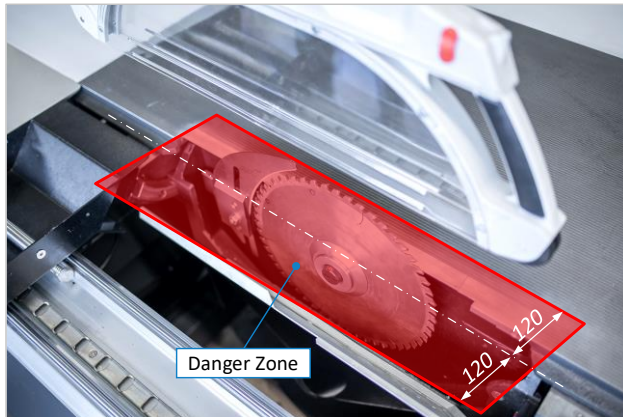



Figure 2: Danger zone saw blade

- The area 120 mm around the saw blade is considered to be a danger area with an increased risk of injury.
- Hands must never be within this danger zone when the saw blade is running!
- Never remove chips and parts lying around with your hands!
- Within the danger zone, use a push stick, push block or other suitable aid for feeding.
- When feeding the workpiece manually, place your hands flat with your thumbs on them and do not spread your fingers.
- Lower the saw blade guard before starting work.

	Be aware of the danger of cutting and being drawn in within the danger zone of 120 mm around the saw blade! Wearing gloves, loose clothing, open hair as well as watches or jewellery is prohibited when working on the sliding table saw!
--	---

5.4.2 Danger Zones around the Machine

Another danger zone is located in front of the machine within the feed area of the saw blade. Here, there is a particular risk of serious injury from a material kickback. During operation, the operator as well as any helpers and possible observers must refrain from being in the marked danger zone!

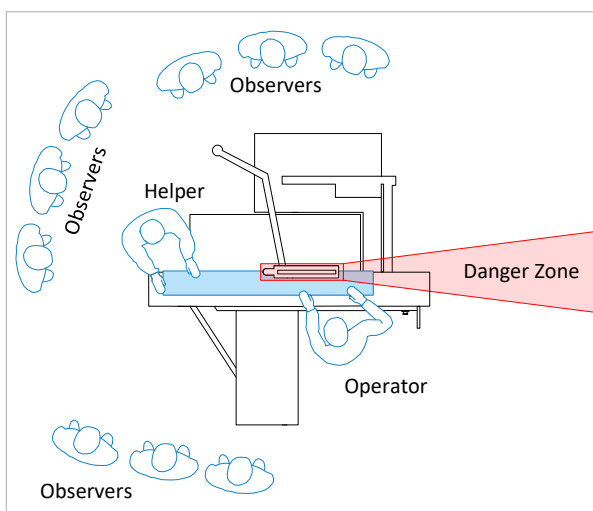



Figure 3: Danger zones around the machine

- The operator of the machine must generally stand at the front of the machine, outside the danger zone (depending on the application, to the left or right of the saw blade (see also ⇨ Figure 7).
- A helper for workpiece removal must generally stand behind the machine and outside the danger zone. The helper must not stand within the movement range of the slide table.
- Observers must stand in a semi-circle formation outside the danger zone. An adequate distance must be maintained so that the operator of the machine and any helper are not hindered in their work.

	Be aware of the danger of kickback due to ejecting workpieces! Entering the danger zone during the cutting process can lead to serious injuries.
---	---

5.5 Avoidance of Kickback Hazards

Uncontrolled kick-back of workpieces and parts must be prevented with all available means, as these provide a very high hazard potential. The kickback area starts from the centre of the saw blade towards the rear, where the saw teeth rotate in an upward direction. If the rising teeth come into contact with the workpiece or loose boards, battens or blocks lying around, these can be ejected immediately, which can cause the most serious injuries. In this section you will find valuable hints to effectively avoid kickbacks.



Many serious injuries on a sliding table saw occur due to workpieces kicking back. To avoid kickbacks, please observe the following sections.

5.5.1 Use fence and saw blade guard

Increased danger exists (as mentioned above) due to parts lying around that are caught by the rising teeth. Equally dangerous is freehand cutting without a guide, because even a trained carpenter's hand is not able to make an absolutely straight cut. If the cut is slightly skewed, the workpiece can twist on the saw table in such a way that it gets into the area of the rising teeth and can be gripped.

- ➔ Therefore, generally use a fence to guide the workpiece and lower the saw blade guard to just above workpiece height.

5.5.2 Never work without the riving knife

The riving knife is an elementary guarantee of safety. It prevents the kerf from closing again behind the saw blade (especially in the case of material with a lot of tension) and thus from jamming with the rising teeth.

- ➔ Only in very few exceptional cases (e.g. when insert cutting) may the riving knife be removed for the duration of the corresponding operation.

5.5.3 Rip fence when cutting short workpieces to width

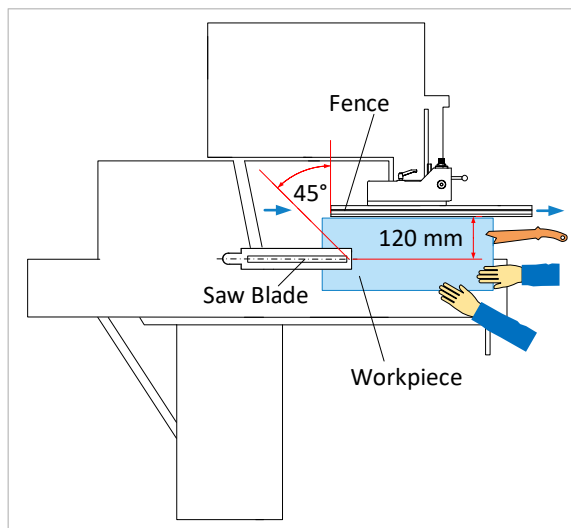



Figure 4: Cutting short workpieces to width

The rip fence must not be set too far towards the saw blade when cutting short workpieces to width. Workpieces that have already been cut can jam between the fence and the saw blade. This is especially dangerous when the workpiece reaches the area of the rising teeth.

- ➔ To move the rip fence out of the danger zone, pull the fence rail back towards the operator's side so that the rear edge of the fence forms an angle of approx. 45° relative to the front edge of the saw blade.
- ➔ For cutting widths < 120 mm, generally use a push stick and < 30 mm an even narrower, sufficiently long wooden strip for feeding.

5.5.4 Parallelism of the rip fence

Regularly check the parallelism of the fence by measuring the front and rear of the machine table. Even a slight deviation of 1 to 2 degrees can press the workpiece against the saw blade in such a way that it jams. Then it can be caught by the rising teeth and trigger a kickback. Ideally, the distance of the fence to the rear (in the direction of the rising teeth) is approx. 0.2 mm higher than in front of the saw blade.

	<i>Danger of kickback due to ejecting workpieces! The distance of the fence in front of the saw blade must never be higher than at the rear in the area of the rising teeth.</i>
---	---

Clear indications that the parallelism of the fence is no longer correct are sluggishness of the workpiece when it is fed, a strong noise development and burn marks on the workpiece. If your fence has been misaligned, please contact our customer service (phone number: 0049 - 7571 / 755-0).

5.5.5 Cutting off small pieces on the rip fence

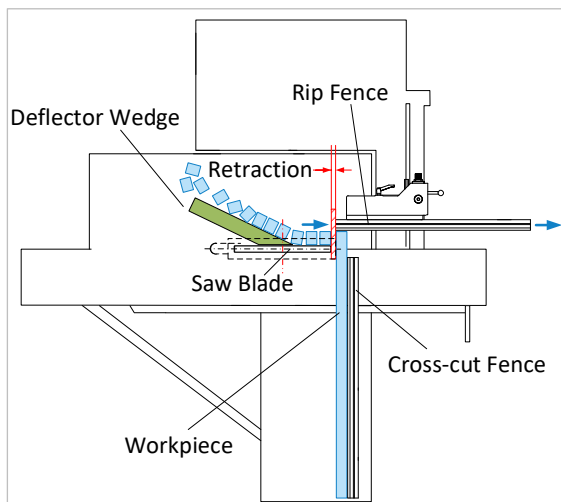

If you are using the rip fence to cut many smaller pieces of identical dimensions from a long piece (which rests against the cross-cut fence), it is important to prevent cut pieces from jamming between the fence and the saw blade and being caught by the rising teeth.

- ➔ To do this, move the rip fence backwards towards the operator's side and fix it so that there is enough space between the fence and the front edge of the saw blade for the retraction (see ⇨ Figure 5).
- ➔ Fix an additional deflector wedge (see ⇨ Figure 5) auf on the table top so that small parts that have already been cut off cannot be caught by the rising teeth and flung upwards.

Figure 5: Fixing the deflector wedge on the table

	<i>Important: The deflector wedge must be fitted so far towards the operator's side that the cut-off parts are already deflected shortly before the centre of the saw blade.</i>
---	---

	<i>Danger of kickback due to ejecting workpieces! Never remove already cut parts by hand and fix a deflector bar on the machine table.</i>
---	---

5.6 Special Characteristics of Guards Made of Polycarbonate (Plexiglas)

Polycarbonate guards require special attention if they are to protect against possible flying tool parts (e.g. in case of tool breakage of cutters or saw blades).

Polycarbonate guards must therefore be checked regularly for deep scratches, cracks, bulges or cloudiness (visual inspection). If corresponding damage becomes apparent, the protective device must be replaced immediately, as the required protective capability is no longer given.

	<p><i>Do not use oils, fuels or solvents to clean and maintain polycarbonate protective devices. Do not use aggressive or toxic industrial cleaners that can damage the windows or bonding. Under no circumstances may nitro thinner be used. The cleaner must be free of hydrocarbons.</i></p>
---	--

5.6.1 Effect of cooling lubricants on polycarbonate

The ingredients in cooling lubricants can negatively influence the material properties of polycarbonate. When cooling lubricants are used regularly (e.g. when machining aluminium), the polycarbonate guards should be renewed every 2 years at the latest. Even if there is no externally visible damage, the material may no longer have the required impact protection.

6 Machine Data

6.1 Technical Specifications

Table size:	1200 x 665 mm
Table height:	900 mm (± 20 mm)
Cutting length slide table:	3200 mm
Main saw blade speed [rpm]:	3000/4000/5000/6000
Cutting height at 90°:	max. 155 mm
Cutting height at 46°:	max. 105 mm
Cutting width (rip fence):	1030 mm
Pull-out cross-cut fence:	max. 3200 mm
Saw blade:	max. Ø 450 mm
Saw blade tilt range:	0° ... +46°
Mitre fence angle:	46° (on both sides)
Saw blade (retractable u. table):	Ø 400 mm
Table extension:	750 x 655 mm
Table widening:	1200 x 600 mm
Motor power:	5.5 kW / 7.5 HP
Motor voltage:	230/400 V / 50 Hz
Protection class	IP54
Slide table surface:	coated
Space requirement:	7000 x 6500 mm
Net weight:	approx. 1051 kg
Suction nozzles:	120 / 80 mm
Manufacturer:	
HOKUBEMA Maschinenbau GmbH	
Graf-Stauffenberg-Kaserne	
Binger Str. 28 Halle 120	
DE-72488 Sigmaringen (Germany)	
Tel.: +49 (0) 7571 / 755-0	
Fax: +49 (0) 7571 / 755-2 22	



PANHANS
by
HOKUBEMA

HOKUBEMA GmbH • D-72488 Sigmaringen
Telefon/phone +49(0)7571 755-0

Formatkreissäge 

Baureihe line	
Typ type	690 I 100
Maschinen-Nr. machine no.	
Baujahr year of construction	202
Bemessungsspannung U = nominal voltage U =	V
Frequenz/Phasenzahl frequency/phases	Hz / 3
Stromart kind of current	AC
Volllaststrom I = operating current I =	A
Überstromschutz, intern excess current protection, internal	A

Figure 6: Nameplate

6.2 Technical Characteristics

- Sliding table saw for trimming, cutting to length, sizing, mitre cutting, etc.
- Dimensionally stable and self-supporting machine body
- Torsion-resistant and finely planed cast iron table top
- Robust and powerful saw unit for precise saw cuts
- Double-guided swivel segments made of grey cast iron
- Double column guide for height adjustment with 2-fold ball bearing mounted, long circular saw shaft for absolutely smooth running and with remote locking in 50 mm grid
- Smooth-running and maintenance-free double slide table (ball-bearing mounted and extra stable) with precise and play-free running over the entire length
- Stable and lightweight cross slide, made of steel profiles with a support roller on the outer narrow side
- Cross-cut fence profile with mm scale and magnifying glass, telescopic extension up to 3200 mm, including two robust and backlash-free flip stops and additional end flip stop
- Manually adjustable rip fence with cutting width 1030 mm to the right of the saw blade
- Rip fence can be folded away for free table surface
- Table widening 1200 x 600 mm and table extension 750 x 655 mm with pull-out tool drawer
- Control panel with 7" touchscreen display for cutting height, tilt adjustment and speed of rotation
- Motorised height and tilt adjustment via push-buttons
- Tilt range of the saw blade 0 - 46°
- APA saw blade quick clamping system
- Main saw blade speed 3000/4000/5000/6000 rpm
- Protective device can be swivelled away to both sides, guard with interchangeable insert wide/narrow
- Push-button control with electronic soft start (start/stop)
- Electronic, wear-free motor brake
- Saw blade Ø 400 mm retractable under the table
- Extraction port Ø 120 mm on machine body, Ø 80 mm on protective hood
- Slide table, length and width stop profile anodised
- Machine body and swivel arm powder coated
- CE-conform, GS tested

6.3 Emission Levels

Noise Information:

The values given are emission levels and therefore do not necessarily represent safe workstation values at the same time. Although there is a correlation between emission and immission levels, it cannot be reliably deduced whether additional precautionary measures are necessary or not.

Factors that may affect the current immission level at the workstation include the duration of exposure, the nature of the workspace, other noise sources (e.g. the number of machines and other adjacent operations). The permissible workstation values can also vary from country to country.

However, this information should enable the user to make a better assessment of hazard and risk.

6.3.1 Noise Emission Values:

The measurement values given are determined in accordance with the EN 1870-1 standard.

Uncertainty allowance $K = 4 \text{ dB(A)}$

Workplace-related emission value	
Idle	87 dB(A)
Operation	85 dB(A)

Noise level	
Idle	99 dB(A)
Operation	101 dB(A)

The measurements were based on the operating conditions according to ISO 7960 Annex A. (with carbide saw blade $\varnothing 350 \text{ mm}$, $Z=54$, 4000 min^{-1} , Soundstar).

	<p><i>The noise emission values of the machine partly exceed 85 dB(A)!</i> <i>Therefore, suitable hearing protection must be provided to the personnel!</i></p>
---	--

Workplace-related dust emission value: The determined values comply with the required assessment values for the "GS wood dust test" mark by the German Woodworkers trade association (Holz BG).

7 Dimensions

7.1 Working Areas

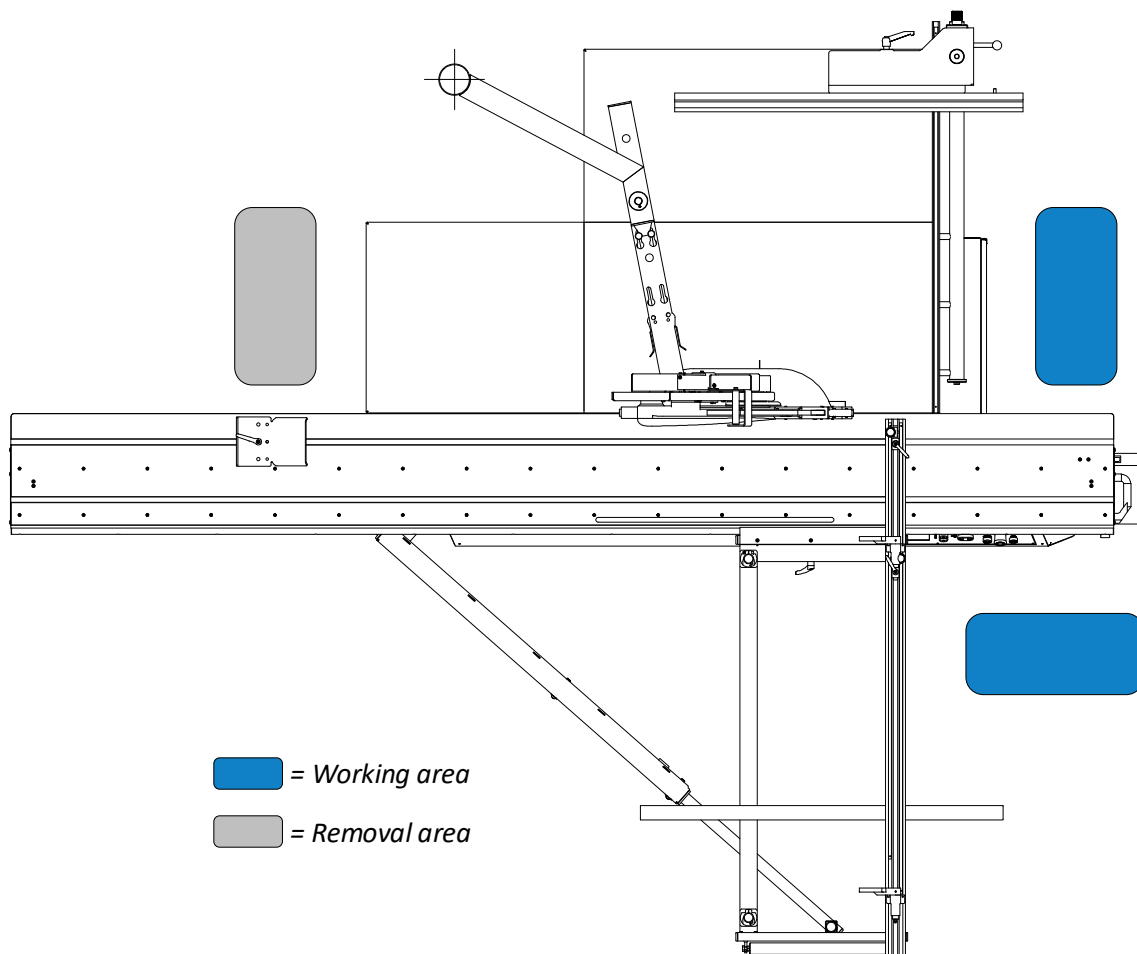

Figure 7: Working areas

7.2 Dimensions (Front View)

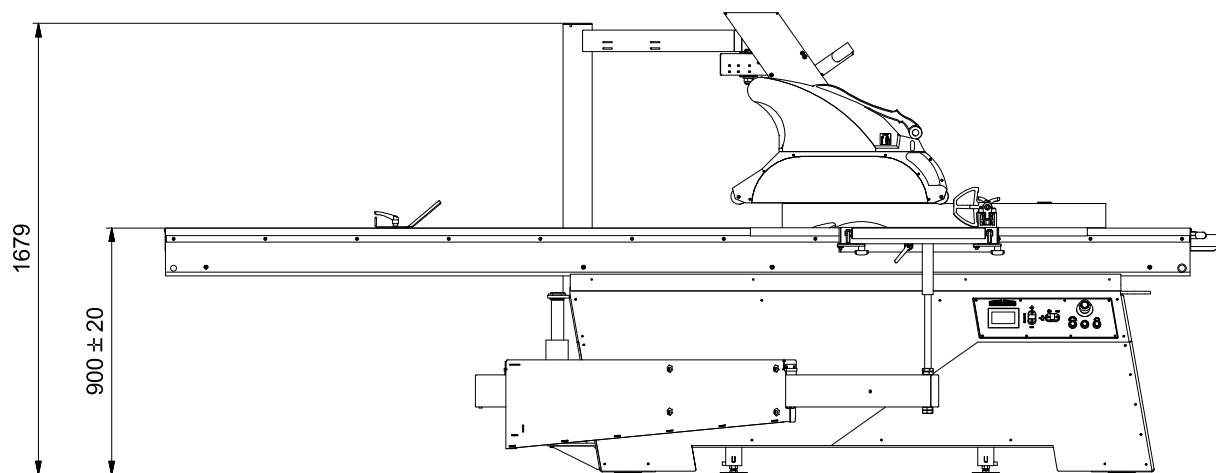

Figure 8: Dimensions (front view)

7.3 Dimensions (Top View)

Sliding table

	Table length / Cutting length
Option	2000 mm / 2000 mm
Option	2600 mm / 2600 mm
Standard	3200 mm / 3000 mm
Option	3800 mm / 3800 mm

A = Aperture

	Cutting width / Aperture width
Option	830 mm / 880 mm
Standard	1030 mm / 1080 mm
Option	1280 mm / 1330 mm

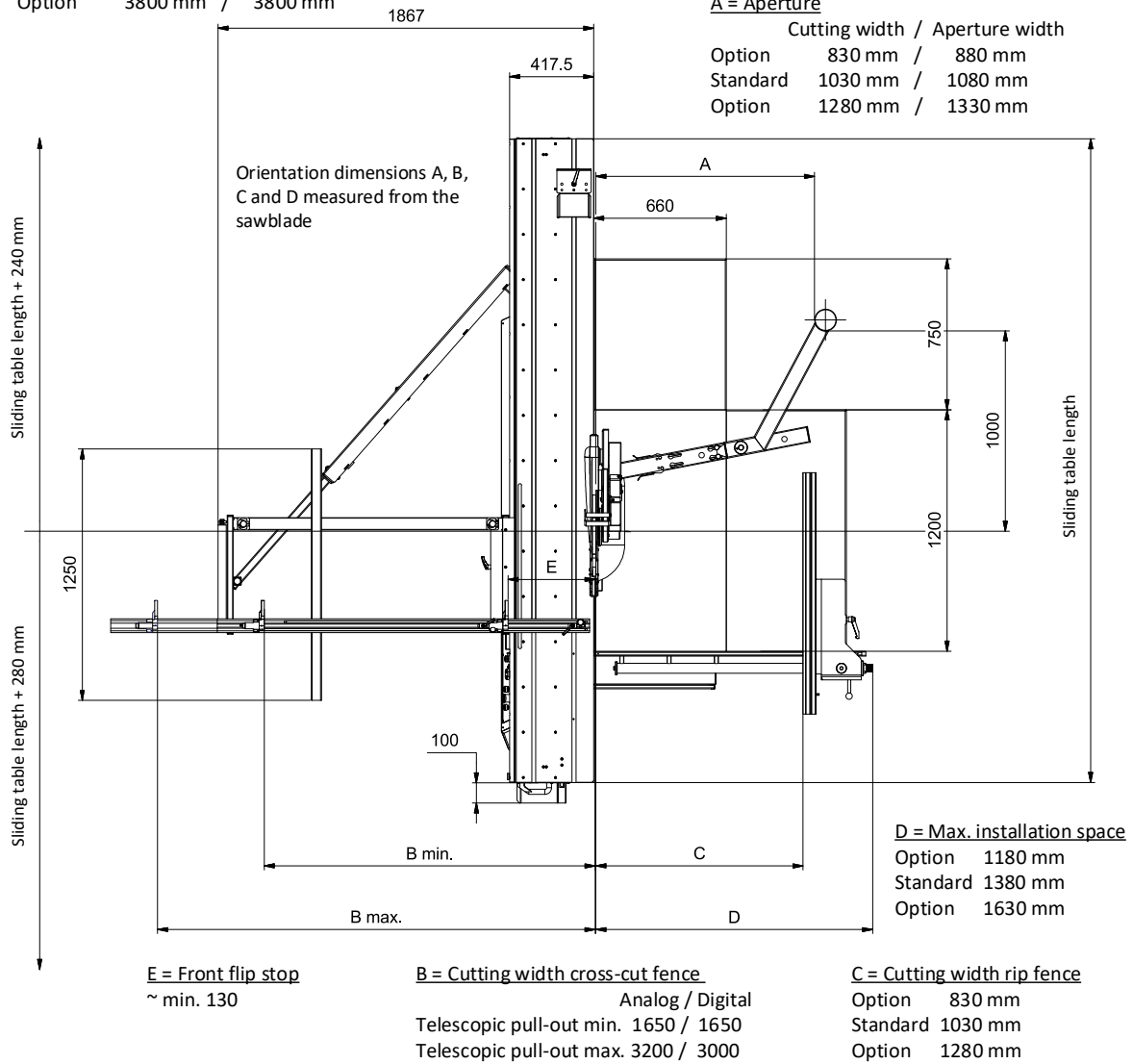

Figure 9: Dimensions (top view)

8 Installation and Connection

8.1 Check Delivery Conditions

Check the consignment for completeness and possible transport damage. In case of transport damage, please keep the packaging and inform the shipping company and the manufacturer immediately! Later complaints cannot be accepted.

8.2 Transport to the Installation Site



Figure 10: Machine transport

- The machine is delivered on a transport pallet and is bolted to the bottom of the pallet.
- The slide table is secured with a transport lock.
- The centre of gravity of the machine is approximately in the middle of the transport pallet.
- If the machine is transported by forklift truck, the pallet must be raised in the area of the centre of gravity.
- Move between the feet with a lift truck, lift the machine only a few centimetres and move it to the installation site.

For transport by forklift pick up the machine as shown above, fork length minimum 1.20 m.

	Caution: Risk of damaging the front plate, longer fork length is advantageous!
--	---

	With the cross slide attached, the centre of gravity shifts towards the cross slide!
--	---

	Pay attention to the danger of tipping over when transporting by forklift truck!
--	---

	Be aware of possible crushing hazards when placing the machine (from the pallet to the floor) by means of a forklift truck or similar. Pay particular attention to your hands and feet and wear safety shoes and protective gloves as a precaution.
--	--

	Danger to life when using a forklift truck! Keep a sufficient distance from the forklift truck and watch its speed. Vehicles with combustion engines also produce toxic exhaust gases. Wear a breathing mask if necessary.
--	---

- Move the pallet to the desired location (using a forklift truck, overhead crane, etc.).
- Loosen the 4 bolts on the feet of the machine.
- Lift the machine of the pallet and move it to the desired location.
- Remove the transport locks on the slide table.
- The bare parts of the machine are greased to protect them from corrosion. Carefully degrease these parts protected against rust with petroleum or benzine.

	Fire hazard! Do not smoke and do not light an open fire.
--	---

	Do not use nitro thinner for cleaning. Painted surfaces of the machine can be damaged.
--	---

- A foundation is not required. The floor must have a load-bearing capacity corresponding to the weight of the machine. The weight of the machine is approx. 1051 kg, depending on the equipment more.

- Level unevenness of the floor by means of the stand adjusting screws (see next section ⇒ 8.3).



Dispose of the packaging material in an environmentally friendly way!

8.3 Levelling with a Spirit Level



Caution: Ensure that all four feet are firmly on the floor, evenly loaded and the machine is levelled with a spirit level.

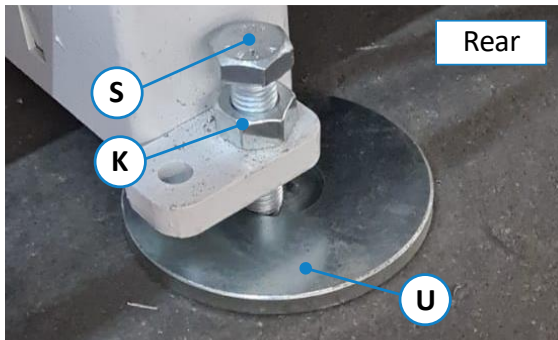

Figure 11: Levelling screws at the rear (normal case)

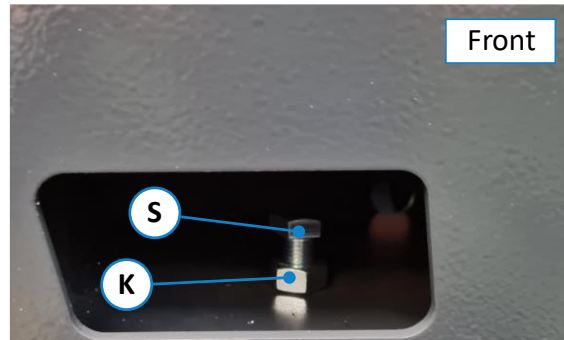

Figure 12: Front levelling screws (exceptional case)

When setting up the machine, it must be properly aligned with a machine spirit level (0.1 mm/ 1 m). For this purpose, the machine has two adjustable feet with corresponding set screws (**S**) on the rear side (⇒ Figure 11) and two round plates (**U**) as a base. In the **normal case**, the front of the machine stands flush on the two pedestals. Level here only in **exceptional cases** (very uneven floors).

8.3.1 Procedure in the Normal Case

1. Before setting the machine down, lower it only close enough to the ground so that the two plate feet (**U**) shown in ⇒ Figure 11 can be placed centred under the screws (**S**).



Caution: Crushing hazard for hands and feet when lowering & setting down the machine!

2. Now lower the machine completely until it is centred on the plate feet with both screws (**S**).
3. To align with the spirit level, it is usually sufficient to adjust only the rear screws (**S**).
4. An open-end spanner SW22 is required for adjustment. First loosen the lock nuts (**K**) and then adjust the height with the set screws (**S**) until the machine is evenly levelled.

8.3.2 Procedure in the Exceptional Case

1. If levelling cannot be achieved with the two rear feet, it must be assumed that the installation site has a very uneven surface.
2. Only in this exceptional case are the front adjusting screws (see ⇒ Figure 12) necessary for levelling. However, these are only accessible after the front cover plate is removed.
3. Before adjusting, raise the machine on the front side so far that the two round plates (**U**) can also be placed here centred under the adjusting screws (**S**).



Caution: Crushing hazard for hands and feet when lowering & setting down the machine!

4. Then loosen the four lock nuts (**K**) shown in ⇒ Figure 12 and ⇒ Figure 11 and adjust the height on all four screws (**S**) until the machine is evenly level.

8.4 Lashing on a Transport Vehicle

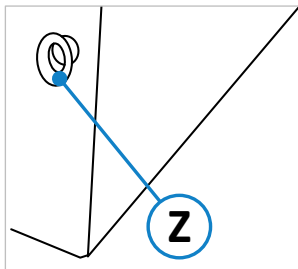

For transporting the palletised machine on a transport vehicle, a lashing point (Z) is attached to each of the four sides of the machine.



A separate lashing strap must be used for each lashing point (Z). All 4 lashing straps must be individually tensioned on the loading area!

The responsibility for safe loading is borne by the respective shipper!

Figure 13: Lashing points (4 x)

Please note the following when lashing in the transport vehicle:

- The loading area of the transport vehicle must always be clean and dry.
- The lashing straps used must be suitable for the total weight of the machine (approx. 1051 kg net).
- Fastening on the loading area is done by lashing down: This means that the transport pallet is secured by frictional locking. The load is pressed so firmly onto the loading surface that it can no longer slip. The clamping tool should have a high STF value at the frictional connection, e.g. long-lever ratchets.
- In addition, anti-slip mats should be used to provide even more safety.
- The ideal lashing angle (α) for tie-down lashing is 83° to and 90°. Therefore, the lashing straps should pull downwards approx. vertically. As the angle decreases, the pretensioning force of the lashing is reduced.
- Observe the permissible total weight of the transport vehicle.
- Ensure that the permissible axle loads of the transport vehicle are observed. The load must be distributed evenly on all axles of the vehicle.

8.5 Temporary Storage

If the machine is not put into operation immediately after delivery, it must be stored carefully in a protected place.

- Carefully cover the entire machine so that neither dust nor moisture can penetrate.
- The bare, non-surface-treated parts (e.g. the cast iron tabletop) are provided with a preservative. This must be checked regularly for effectiveness and renewed if necessary.

8.6 Connecting the Extraction Unit

The air velocity must be checked before initial commissioning and after significant changes. The extraction system must be checked daily for obvious defects after initial commissioning and monthly for effectiveness.

The machine must be connected to an effective extraction system on-site. The upper extraction nozzle on the extraction hood has a diameter of 80 mm. The diameter of the lower extraction nozzle on the machine stand is 120 mm.



When the machine is switched on, the extraction system must start automatically.

Two signal transmitter lines for automatic switching of the extraction unit can be connected to the terminals "03" and "04" of the contactor "K2".

Installation only by a qualified electrician!

The air speed must be set in such a way that, with the extraction line connected and the tools stationary, an average air speed of

- 20 m/s (1450 m³/h) with dry chips,
- 28 m/s (2050 m³/h) with moist chips (moisture 18 % or more)

is achieved at the extraction nozzles.

Existing negative pressure at 20 m/s: Total connection 140 mm \varnothing / approx. 1200 Pa



When flexible suction hoses are used, they must be flame-retardant.

All parts of the extraction system, including hoses, must be included in the earthing measure.

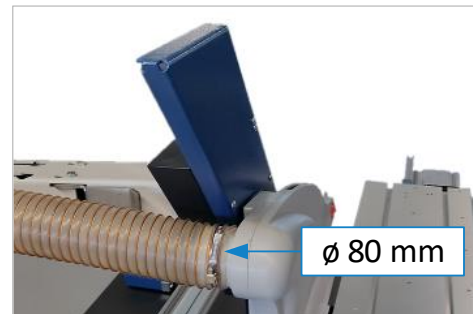

Figure 14: Upper suction nozzle diameter

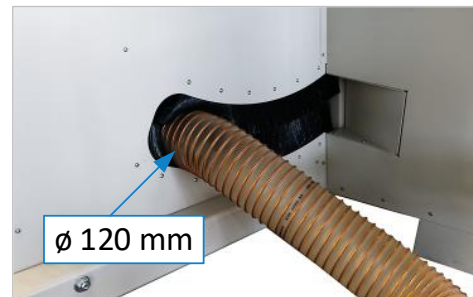

Figure 15: Lower suction nozzle diameter

8.7 Electrical Connection

	The electrical connection must be carried out by an authorised electrician!
---	--

The electrical circuit diagrams are located in the control cabinet.

Please observe the specified nominal voltage 400 VAC / 50 Hz (3 phases / N / PE)!



Connection to the mains (3 phases) is made at the terminal strip in the terminal box. The 3 phases are to be connected to the terminals “L1”, “L2”, and “L3”. The protective earth wire (yellow/green) must be connected to the terminal marked “PE”.

With optional machine socket, the neutral conductor must be connected to the terminal marked “N” (please note: “N” is loaded!).

Then close the cable gland so that it is dust-tight again.

Observe the rotational direction of the saw blade!

	If the rotational direction of the saw blade is wrong, two outer conductors must be interchanged.
---	--



	Correct direction of rotation of the saw blade: Clockwise (when viewed from the front).
--	--

Figure 16: Electrical connection

8.7.1 Back-up Fuses (On-site)

The regulations of the local electric power company apply!

Motor Power	5.5 kW	7.5 kW
400 Volt	25 A	35 A slow

	The fault loop impedance and the suitability of the overcurrent protection device must be checked at the installation site of the machine.
---	---

Supply cable: Cu, 5-wire.

The cross-section must be determined on site by a qualified electrician!

9 Components & Controls

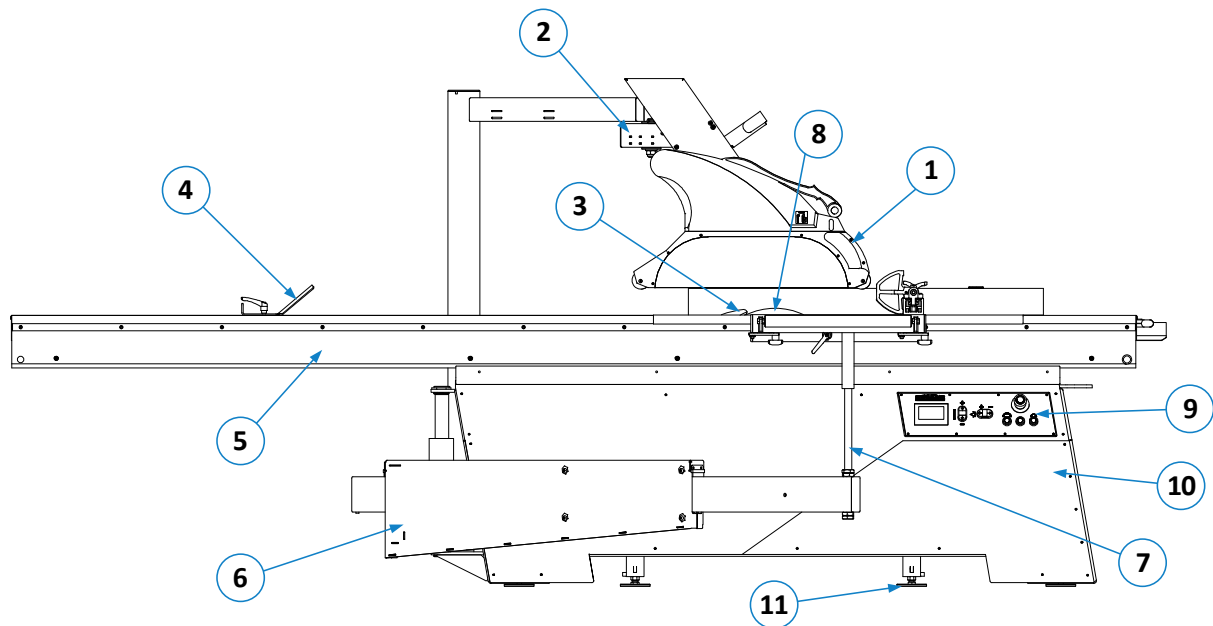

Figure 17: Components & controls - front view

No.	Description	No.	Description
1	Saw blade guard with suction	7	Support bolt
2	Swivel arm for saw blade guard	8	Saw blade
3	Riving knife	9	Control panel
4	Sliding shoe	10	Machine body
5	Sliding table	11	Adjustable foot
6	Telescopic swivel arm		

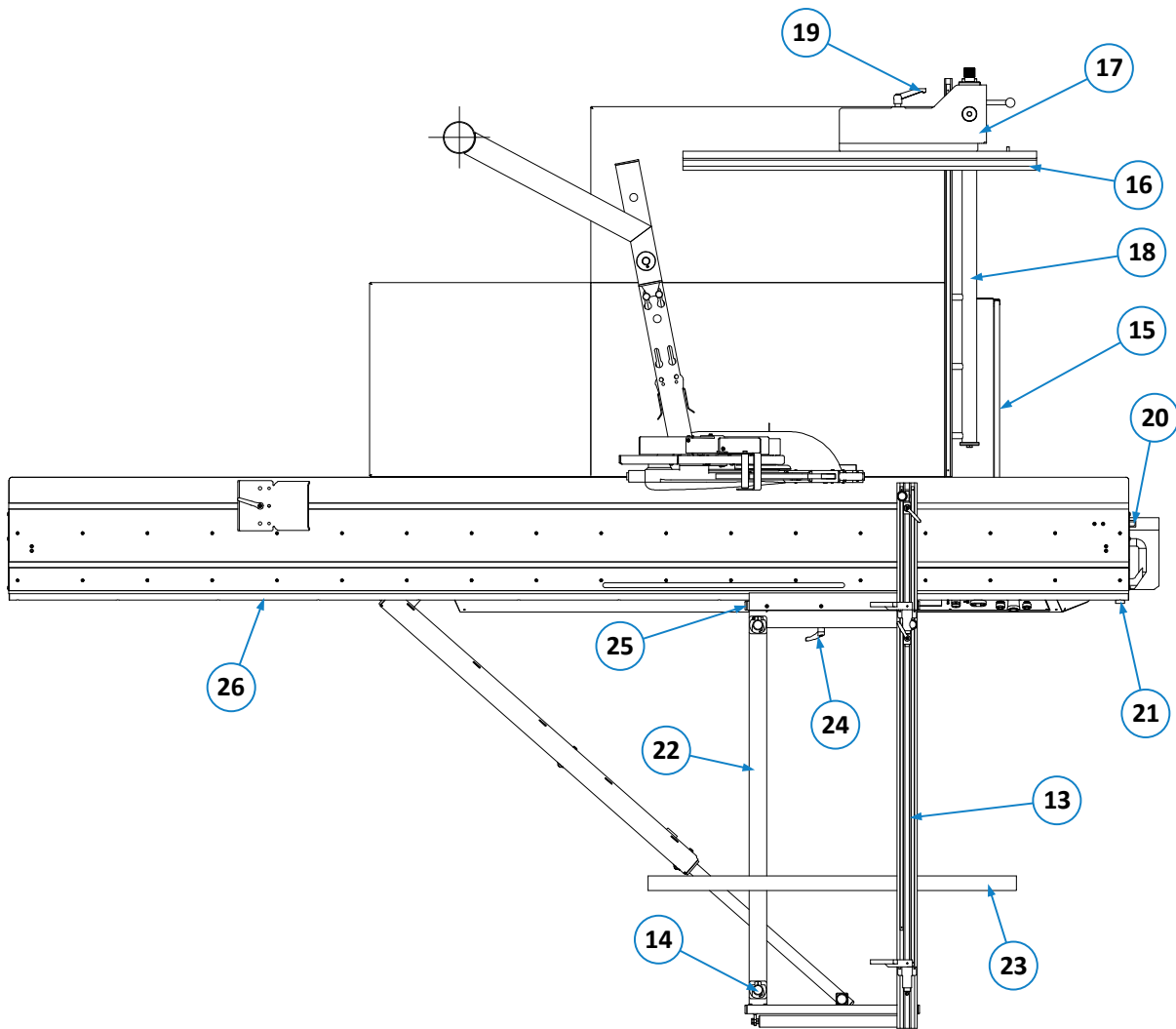
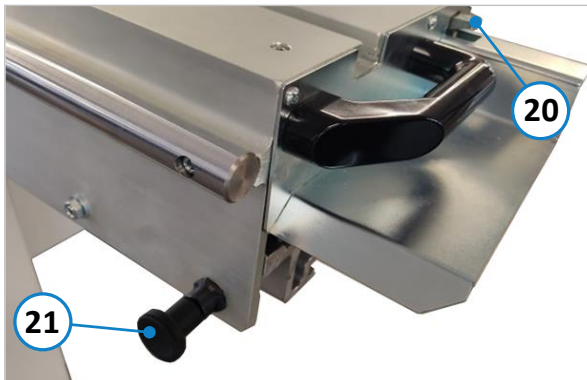

Figure 18: Components & controls - top view

No.	Description	No.	Description
13	Cross-cut fence	20	Safety catch for saw blade change
14	Fixing point for cross-cut fence (4 x)	21	Remote locking for slide table
15	Control cabinet with main switch and e-stop	22	Cross slide
16	Aluminium profile rail for rip fence	23	Cross slide support bar
17	Rip fence	24	Cross slide clamping lever
18	Mechanical rip fence guide	25	Cross slide hook-in bar
19	Clamping lever for profile rail	26	Cross slide guide

10 Mounting and Usage

10.1 Slide Table



When the sliding table saw is delivered, the slide table is already fitted ready for operation.

- Loosen (pull out) the remote locking device (21).
- Move the slide table to the desired position.
- Close (press in) the remote locking device (21). You may have to move the slide table slightly forwards or backwards so that the lock engages correctly.

Figure 19: Slide table controls

The safety catch (20) is used to move the slide table out of the saw blade area (beyond the stop) during a saw blade change (for more information see chapter ⇨ 15.1).



If the machine is not used for a longer period of time, the slide table should be moved to a middle position. This prevents the rollers from being pressed in.



The slide table must not be locked during a cutting operation.

10.2 Rip Fence

The rip fence is used to feed the workpiece from the rear of the machine (to the right of the saw blade).



Figure 20: Rip fence

The rip fence is already fitted when the sliding table saw is delivered. Only the aluminium profile rail (4) still has to be inserted (see next page and ⇨ Figure 21).

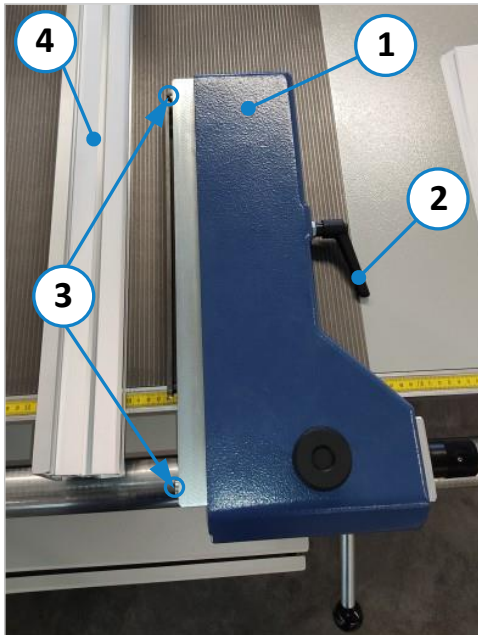
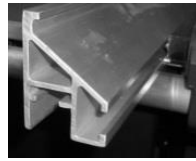

Figure 21: Fitting the rip fence

Set the aluminium profile rail for normal cuts:



- Push the aluminium profile rail (4) as far as it will go onto the two fixing bolts (3) of the holding block. The cross-section must look as shown in the photo on the left.
- Fix the aluminium profile rail by means of the clamp lever (2). The rip fence is now ready for use.

Set aluminium profile rail for inclined saw blade:

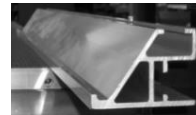

- Push the aluminium profile rail (4) onto the holding block rotated by 90°. The cross-section must look as shown in the photo on the left.
- Fix the aluminium profile rail by means of the clamp lever (2).



Warning! Danger of crushing between aluminium profile rail (4) and rip fence (1).

10.2.1 Operating the Rip Fence



Important: For the operation of the rip fence, please also observe the hazard warnings in the sections ↪ 5.5.3, ↪ 5.5.4 and ↪ 5.5.5.

The rip fence is used to feed the workpiece from the rear of the machine (to the right of the saw blade).

- The rail (4) serves to guide of the rip fence (1).
- The toggle lever (6) is used to fix and release the rip fence on the ruler rod (8).
- The rotary handle (7) is used for fine adjustment.
- The adjusting screw (5) is used for locking.
- The ruler (9) indicates the cutting dimension.



Warning! Danger of crushing between the workpiece or the aluminium profile rail and the slide table.

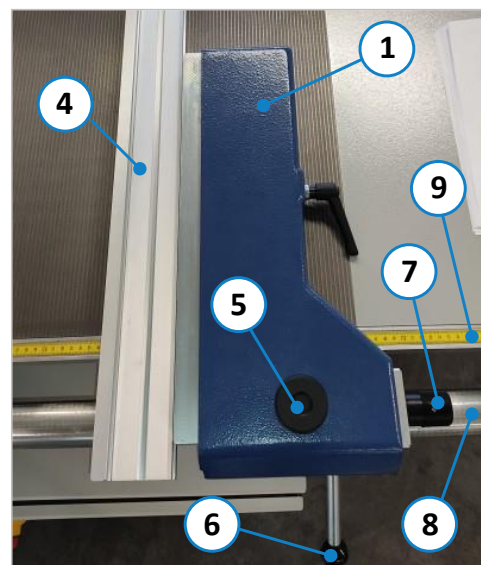

Figure 22: Operating the rip fence

10.3 Mounting the Cross Slide

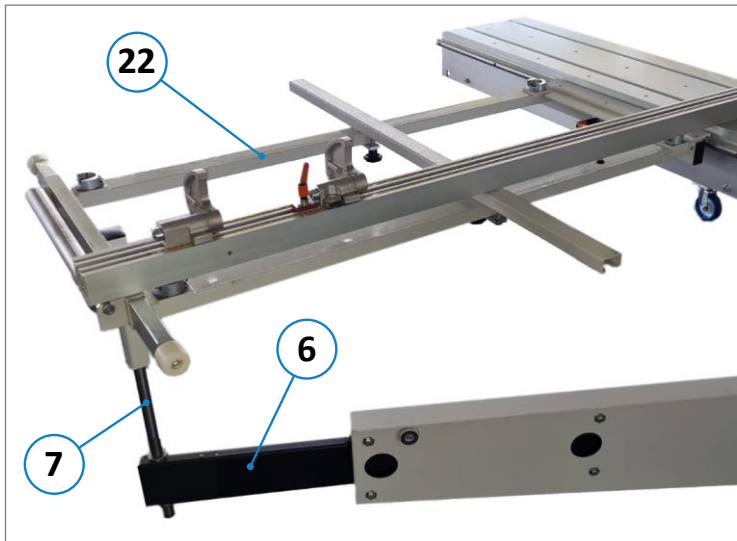

Figure 23: Cross slide mounting

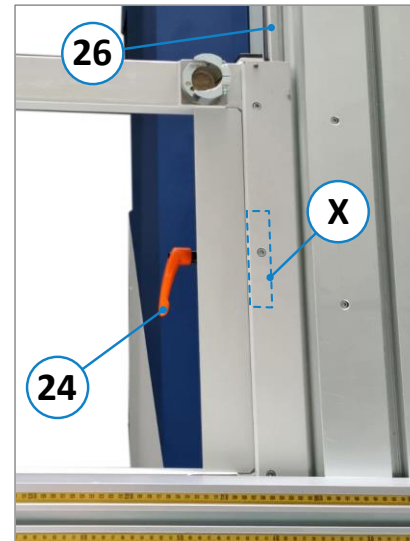

Figure 24: Cross slide clamping

- Pull the slide table into the rearmost position and bring the swivel arm (6) into position.
- Lift the cross slide (22) with 2 persons and place it on the support (7) for the cross slide.
- Loosen the clamping rail (X) - in Figure concealed under the hook-in bar (25) - by means of the clamping lever (24).
- Insert the clamping rail (X) into the cross slide guide (26) on the slide table.
- Fix the cross slide (22) by means of the clamping lever (24).



Warning! Danger of crushing when mounting the cross slide (clamping rail / cross slide).

10.3.1 Moving the Cross Slide



Figure 25: Moving the cross slide

The procedure for moving the cross slide (22) is as follows:

- Loosen the clamping lever (24).
- Move the cross slide (22) to the desired position.
- Fix the clamping lever (24).

10.4 Swivelling Saw Blade Guard

Working position:

- In the working position above the saw blade (middle position) both levers (1) and (2) must be closed

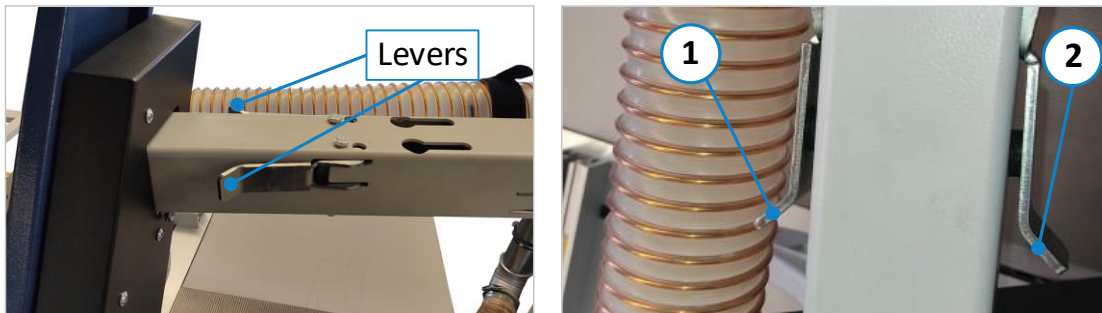

Figure 26: Swivel arm for saw blade guard

Swivel away to the right or left:

- Open the left lever (1) to swivel the guard to the right.
- Open the right lever (2) to swivel the guard to the left.

Swivel back into the working position:

- The guard automatically locks into the centre position (= working position) when swivelled back.
Important: Nevertheless, make sure that both levers (1) and (2) are closed before starting work.

10.5 Change Saw Blade Guard

The sliding table saw is delivered with the blade guard already fitted. However, it may be necessary to exchange the blade guard.:

- If the mounted guard is damaged or defective.
- A special (wider) guard must be used for mitre cuts.

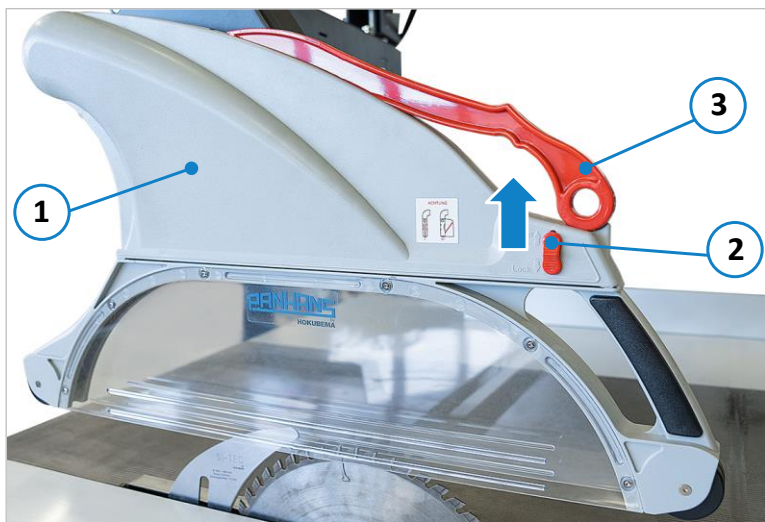

Figure 27: Fitting the saw blade guard

Fitting the saw blade guard:

1. Push the guard (1) to the uppermost position.
2. Set the lock (2) to the "Open" position so that the protective hood disengages.
3. Pull out the guard (1) and lay it down¹.
4. Insert the other guard until it engages and set the lock (2) back to the "Lock" position.

After use, always place the push stick (3) in the holder on the guard unit.



The wider saw blade guard must always be fitted when working with a tilted saw blade.

¹ The guard that is not needed can be stored in the storage tray at the rear (under the tabletop, to the left of the column).

11 Commissioning

Please observe the accident prevention regulations!

	<p>Before switching on, check that</p> <ul style="list-style-type: none"> • there are no loose parts on the tabletop and that all tools have been removed, • the riving knife is correctly adjusted and the sawdust flap is closed, • the slide table is in working position, • the saw blade guard is properly fitted, • the V-belt is properly tightened, • the extraction system is connected and in working order, • the correct speed is displayed, • no persons are in a danger zone of the machine.
---	---

11.1 Control Elements

The following controls are available on the control panel of the 690|100 sliding table saw:

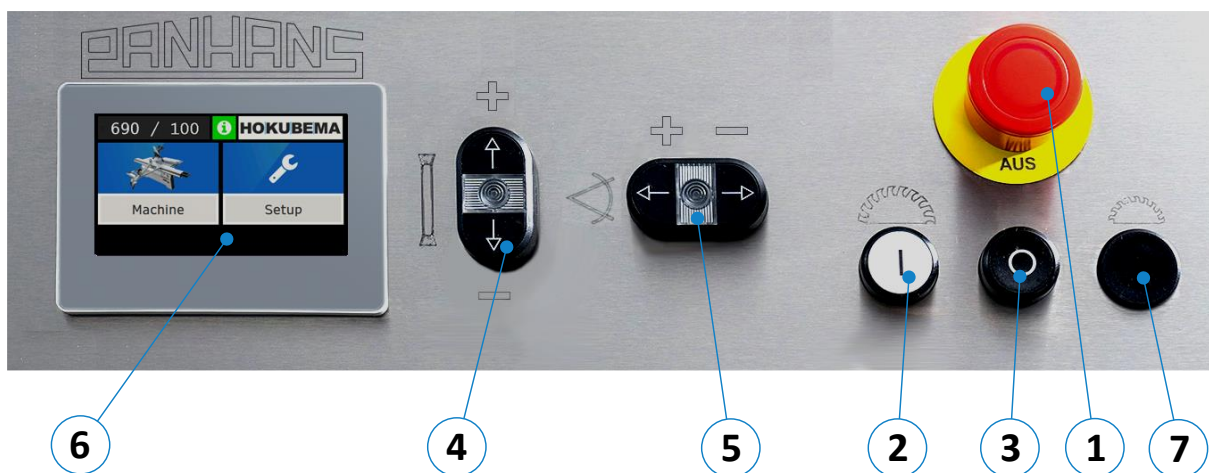

Figure 28: Control elements

No.	Description	No.	Description
1	Emergency Stop	5	Saw blade angle adjustment (up to 46°)
2	Switch on main saw (lights up when "ON")	6	Indicator height / angle / speed
3	Switch off main saw	7	Preparation switch scoring saw (option)
4	Saw blade height adjustment		

11.2 Switching ON

- Turn the main switch (right on the control cabinet) to position "I".
- Press the push-button "Switch on main saw" (2) and wait until full speed is reached.
- Start cutting operation.

11.3 Switching OFF

- To switch off, press push-button (3) → The machine is slowed down.
- Turn the main switch (right on the control cabinet) to position "0".

11.4 Safety Equipment

The machine is equipped with the following safety systems:

11.4.1 Saw Blade Guard with Extraction

The swivelling guard has a lowerable protective hood with interchangeable insert (for wide and narrow) and a suction port. The guard thus ensures both effective extraction of chips and sawdust and an effective saw blade protection.

11.4.2 Safety Switches

The sawdust flap is equipped with a safety switch. This has the effect that the power supply to the main motor is switched off when the sawdust flap is opened. The same applies to the slide table. This has a safety switch that switches off the power supply to the main motor as soon as the slide table is above the centre of the machine. Furthermore, the maintenance cover at the rear of the machine is equipped with a safety switch.

11.4.3 Emergency Stop Switches

The sliding table saw is equipped with two emergency stop switches (one each on the control panel and on the right of the workpiece feed side on the control cabinet).

The emergency stop switches must always be freely accessible and must not be obstructed by wood or other objects.



Restart after emergency stop:

1. Check that there is no longer any danger (determine the reason for triggering the emergency stop) and that there are no persons in a danger zone.
2. Unlock the emergency stop switch.
3. Restart the machine.

12 Operating the Cross-Cut Fence



Figure 29: Flip stop with measuring scale and magnifying glass

The proven and easy-to-operate cross-cut fence of the 690|100 sliding table saw is equipped with two flip stops and allows cutting lengths of up to 3200 mm.

The cutting length can be set via a scale with magnifying glass and the flip stop can be fixed in the desired position with a clamping lever. The cutting length is adjusted as follows:

- Flip stop (A): 0 - 1885 mm
- Flip stop (B): 1885 - 3200 mm

12.1 Setting Lengths > 1885 mm

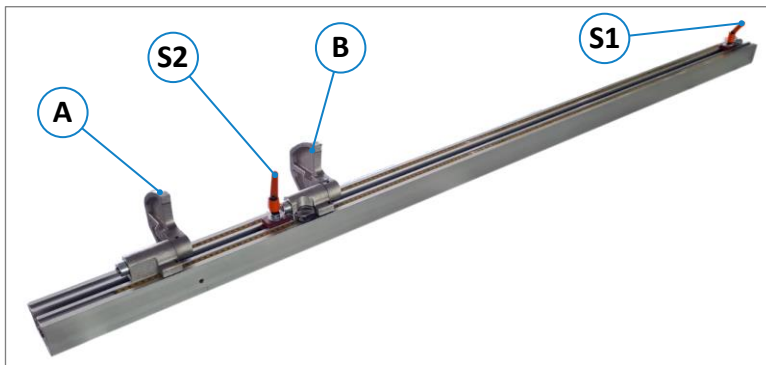

Figure 30: Cross-cut fence operating elements

- Loosen the flip stop (A) with (S1), adjust to 1885 mm with magnifying glass and clamp with (S1) again.
- Loosen the flip stop (B) with (S2), adjust the desired cutting dimension and clamp with (S2) again.

12.2 Readjusting the Fence Rulers

If the cutting dimensions no longer correspond to the set length, the measuring scales for the cross-cut fence can be readjusted. For this purpose, the rulers can be moved back to the exact position manually after loosening the fixing screws (F) on the bottom side.

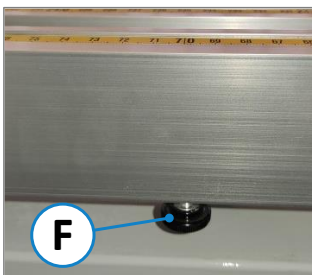

Figure 31: Fixing screw

Procedure:

- Set the corresponding flip stop to any position.
- Move a workpiece to the flip stop and make a test cut on a test workpiece.
- Then measure the cut workpiece and note the dimension.
- Align the rulers with the stop so that the measured dimension exactly matches the scale of the rulers.
- Then tighten the two fixing screws (F) again.

12.3 Cross-Cut Fence Accessories and Options

- For angle and mitre cuts, the cross-cut fence can also be combined with the optionally available "SuperGehrfix I" (see ⇒ 16.4) and "SuperGehrfix II" (see ⇒ 16.5) mitre fences.
- As an option to the standard cross-cut fence, the Tele-Digit (see section ⇒ 16.1) is also available with variant with two wireless digital indicators and two battery-operated operating measuring systems.
- These and other options can be found under "Options and Accessories" in section ⇒ 19.2.

13 Operating the 4.7" Touch Display

The 4.7" touch display visualises the height and tilt of the saw blade as well as the selected speed.

13.1 Start Screen

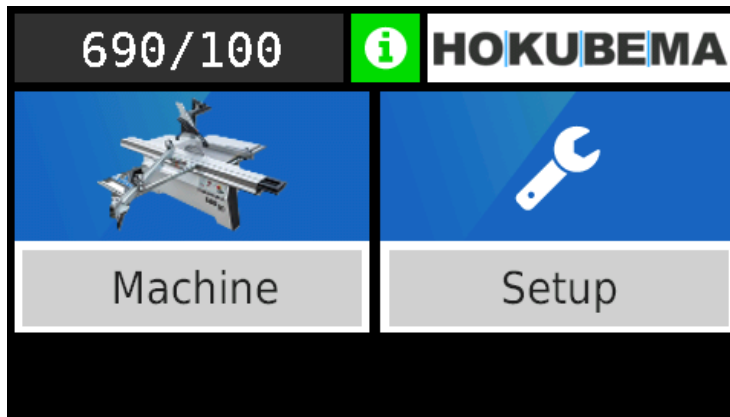



Figure 32: Start screen

- To be able to operate the machine, press the “**Machine**” symbol (see section ⇒ 13.4).
- The “**Setup**” menu is password-protected and not relevant for the operator.

13.2 Status Window

To open the status window, press the icon .

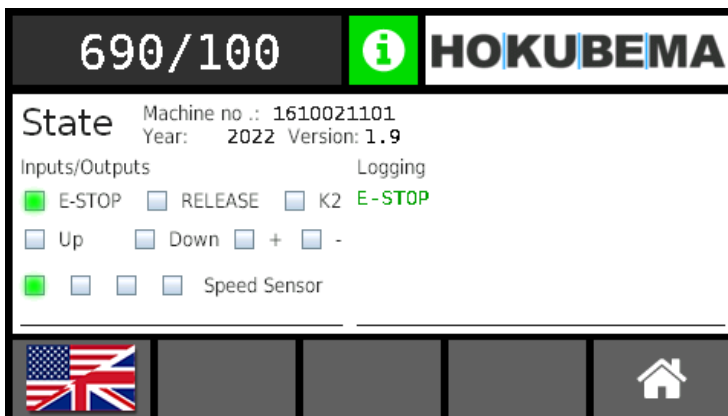

Figure 33: Status window

State / Symbol	Meaning
E-STOP	Lights up green if emergency stop chain ok or red if malfunction in emergency stop chain.
RELEASE	Monitoring of the voltage release for the adjusting motors of the two axes. → The field must light up when one of the two positioning buttons is pressed.
K2	Status message “Main Motor running”
Up / Down	Hardware test of buttons up/down (height) → Lights up when the resp. button is pressed
+/-	Hardware test of buttons +/- (angle) → Lights up when the resp. button is pressed
Speed Sensor	Indicates the V-belt position of the speed sensor
Logging	Displays present errors and faults as text (present = red / remedied = green)
Flag	Open the language menu / switch the language (see next section 13.3)
Home	Jump back to the previous level

13.3 Language Settings

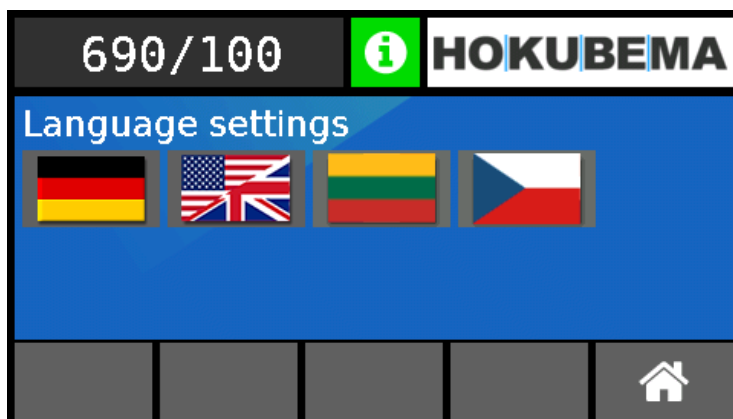

Figure 34: Language settings

- After selecting the flag symbol, the screen shown above appears.
- To change the language, simply select the desired flag symbol.
- The new language is saved automatically (no confirmation required).
- Press the **“Home”** button to return to the main menu).

13.4 Machine Overview

After pressing the **“Machine”** button, the following mask appears:

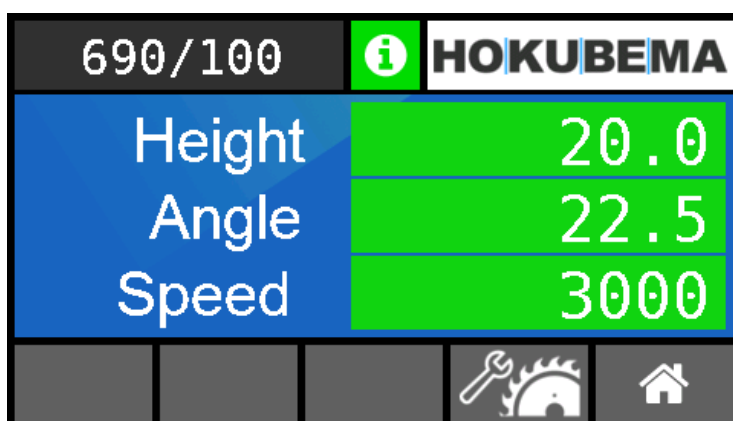



Figure 35: Machine overview - current positions and speed

All current positions of the saw blade and the selected speed are displayed here.

- To adjust the speed, follow the instructions in chapter ⇒ 14.
- To calibrate the height and angle of the saw blade, press the button  and follow the instructions in the next section ⇒ 13.5.

13.5 Saw Blade Calibration

When the machine is delivered, the touch display is already fully calibrated for a \varnothing 350 mm saw blade. In the following cases, the axes for height and/or angle must be recalibrated:

- If the cut length or the cut angle is no longer correct.
- If the saw blade has been replaced or resharpened.
- If a saw blade with another diameter is used.

Press button  to open the calibration menu.

13.5.1 Calibrate Height

- **Important:** Set the saw blade tilt to an angle of exactly **0.0°** using the positioning keys.
- Switch off and secure the main switch on the control cabinet.
- Then turn the stationary saw blade by hand so that one saw tooth is exactly at the top in the centre of the axis. Its cutting surface must be at an angle of 90° to the machine table.
- Switch on the main switch again.
- Set the saw blade height to **50.0 mm** using the positioning keys and a suitable measuring device (e.g. depth caliper gauge).
 - If the saw blade is incorrectly set, a value deviating from 50.0 mm (e.g. 50.5 mm) appears in the overview **"Machine >> Height"** (see ⇨ Figure 35) .

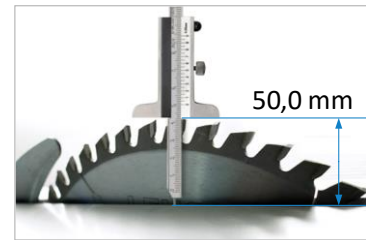

Figure 36: Saw blade height 50 mm

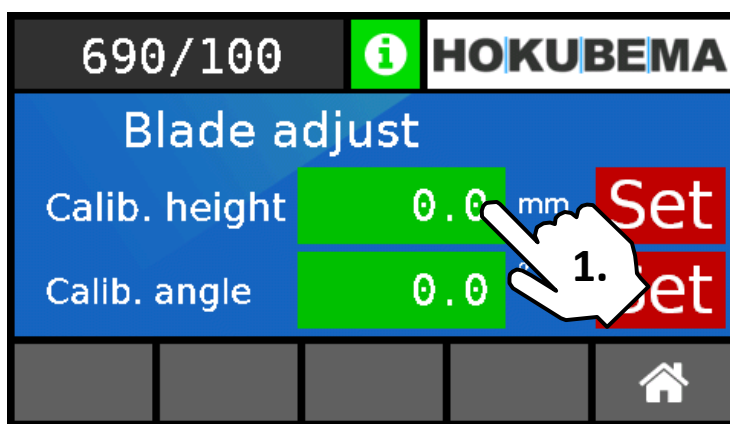
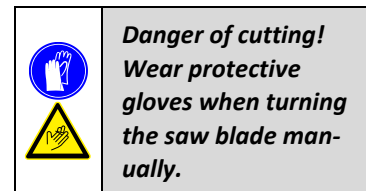

Figure 37: Calibrate height

1. Touch the value field **"Calib. Height"**
 - The keyboard (see figure above right) appears.
2. Enter here the reference value of **50.0 mm** positioned by means of the measuring device.
3. Confirm with **"ENTER"**
 - The entered value is adopted into the field **"Calib. Height"**:

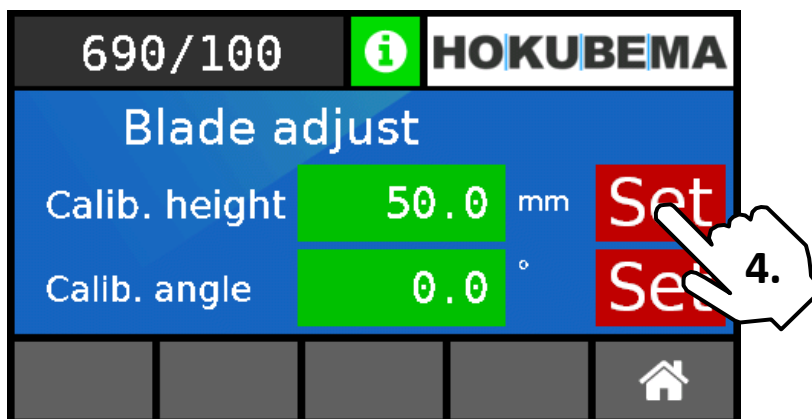
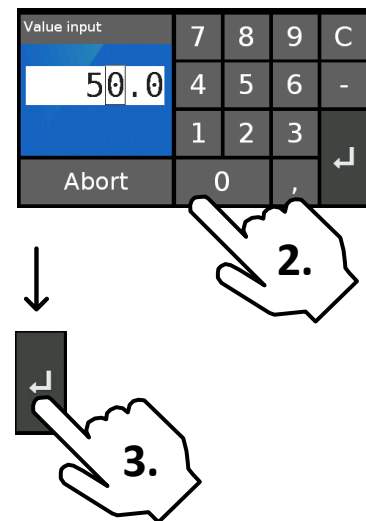

Figure 38: Adopt calibration value for height

4. Press the **"Set"** button to reference the value in the **"Calib. Height"** field.
 - As confirmation, the screen jumps back to the overview (see ⇨ Figure 35).
 - The calibration procedure for the saw blade height is completed.

13.5.2 Calibrate Angle

- Move the saw blade set to 0° to the uppermost position
- Then switch off the main switch and secure or lock it.
- Use a 90° stop angle to check that the saw blade is square.
- If an angular gap appears here, the angular axis must be calibrated.
 - Switch on the main switch and correct the angle via the positioning keys until the angle gap has completely disappeared again. In the 0° position, the saw blade is then exactly 90.0° to the table top.
 - In the overview “Machine >> Angle” (see ⇨ Figure 35) a value deviating from 0.0° now appears (e.g. 0.4°).

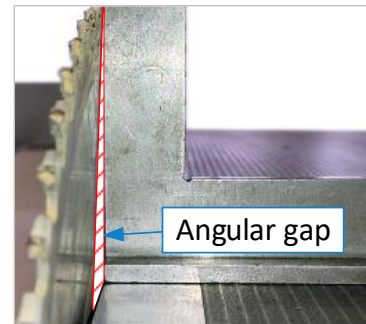

Figure 39: Angular gap

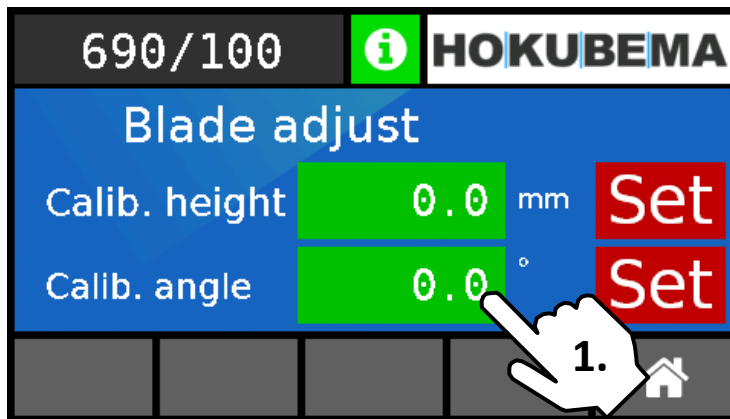

Figure 40: Calibrate angle

1. Touch the value field “Calib. angle”

→ The keyboard (see figure above right) appears.

2. Enter the reference angle 0.0° for the saw blade here.

Note: If 0.0° is already entered here, no entry is necessary.

3. Confirm with “ENTER”

→ The correct 0° position is adopted into the “Calib. angle” field:

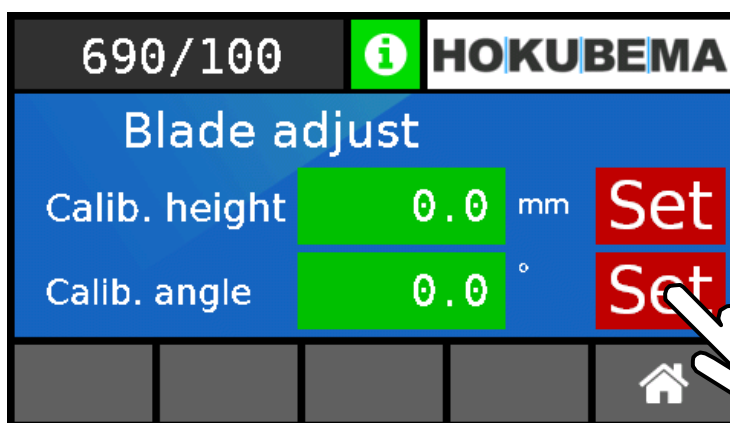
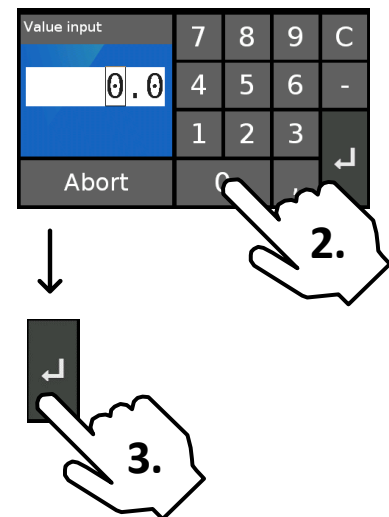

Figure 41: Adopt calibration value for angle

4. Press the “Set” button to reference the value in the “Calib. angle” field.

→ As confirmation, the display jumps back to the overview (see ⇨ Figure 35).

→ The calibration procedure for the saw blade angle is completed.

13.6 Date and Time (from software version 1.9)

From software version 1.9, the touch display also has a date and time function.

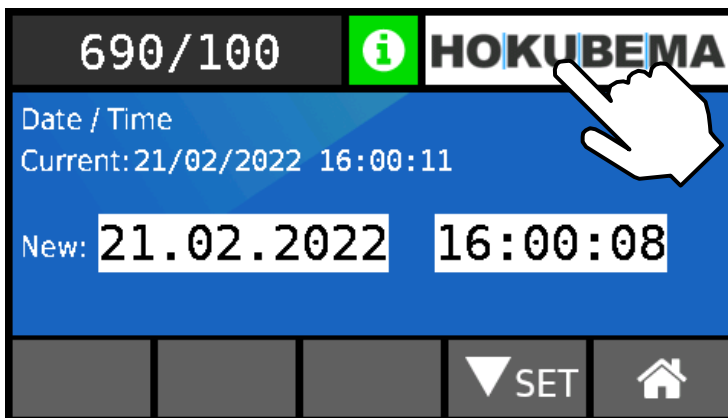

Figure 42: Set date and time

Show date and time:

- Tap on the HOKUBEMA logo
→ The current time is displayed
- Tap on the time displayed
→ The current date is displayed
- Tap on the date displayed to return to the logo

Set date and time:

- Tap the logo for at least 3 seconds
→ The setting menu opens.
- Set the date and time via the keyboard and confirm with "Set".

14 Speed Setting

The speed is adjusted by manually shifting the V-belt.

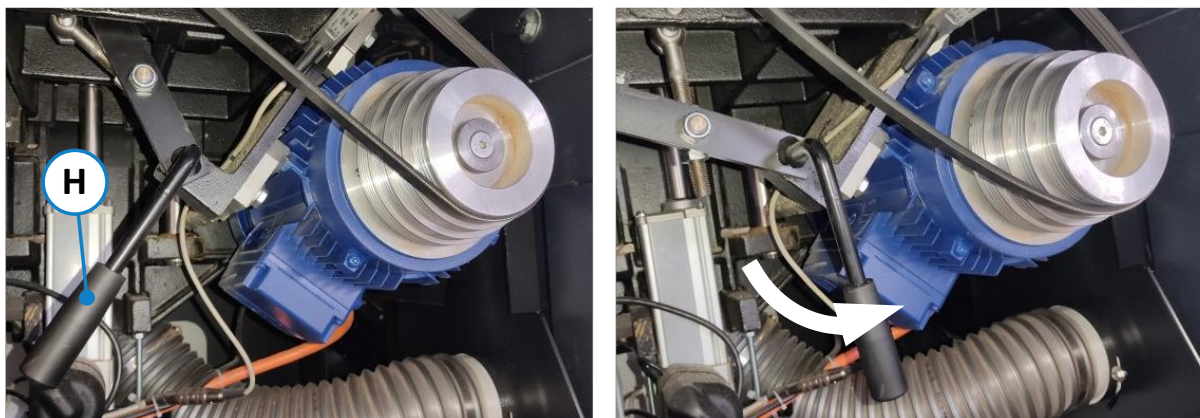
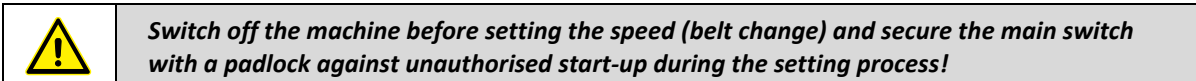

Figure 43: Speed setting - loosen V-belt

- Tilt the sawing unit to 15 degrees position.
- Turn the main switch to position "0".
- Open the rear maintenance door.
- Swivel the adjusting lever (H) to the right
→ The V-belt is loosened.
- Now shift the V-belt to the desired speed according to ⇔ Figure 44. **Rule of thumb:** Always change from "large" to "small" first.
- When shifting, always ensure that the V-belt is again correctly positioned between the speed fork. Otherwise no correct speed indication can be given.
- Swivel the adjusting lever (H) to the left
→ The belt is tightened again.

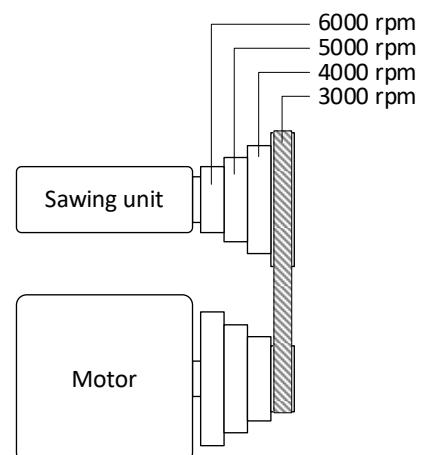



Figure 44: Speed scheme

The speed is sensed by means of a fork light barrier!

15 Changing the Saw Blade

	<p>Work at the saw blades must always be carried out with extreme care. There is an increased risk of injury due to the very sharp cutting edges! Protective gloves must be worn when changing saw blades!</p>
---	---

15.1 Remove Saw Blade

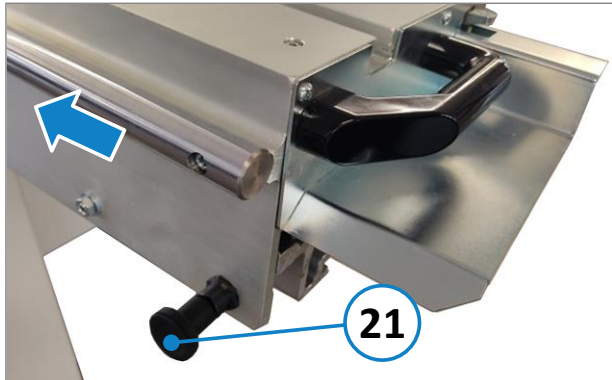

Figure 45: Remote locking on the slide table

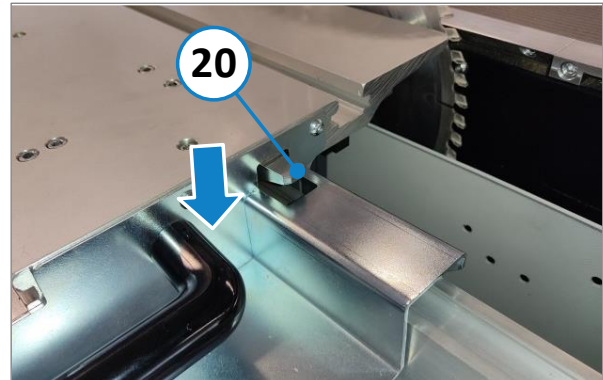



Figure 46: Safety catch on the slide table

- Turn the main switch on (position "I").
- Set the sawing unit height to the uppermost position and the angle to 0°.
- Pull the remote locking (21) to unlock the slide table.
- Push the slide table to the left until the stop. By pressing the safety catch (20), see also section ⇨ 10.1, the slide table can be moved out over the stop for changing the saw blade.

	<p>The saw blade must not be tilted when the sawdust flap is open !</p>
---	--

- Fold sawdust flap (S) forwards.
- Turn the saw blade shaft (W) by hand until the grub screw of the tensioning screw is up.
- Loosen grub screw with an SW 4 pin spanner.
- Now unscrew the clamping screw by hand (**left-hand thread!**) and remove together with the flange.

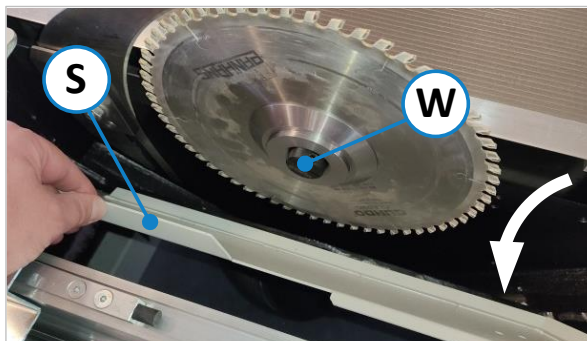

Figure 47: Fold sawdust flap forwards

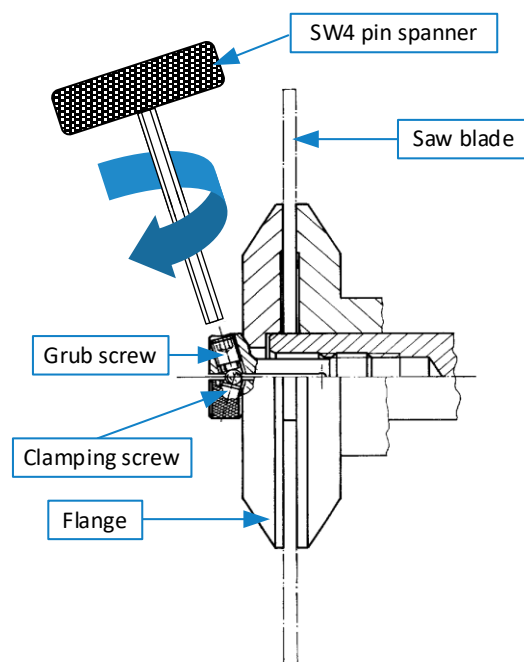



Figure 48: Saw blade flange

15.2 Insert Main Saw Blade

- Clean flange and saw blade.
- Insert the new saw blade and mount the flange (**observe the direction of rotation!**)
- Screw in the clamping screw by hand as far as it will go (**left-hand thread!**).
- Tighten the grub screw of the clamping screw with a torque of 12 Nm.
- Close sawdust flap again.

15.3 Riving Knife Setting

The correct adjustment of the riving knife is of great importance for safety. The gap between the riving knife and the saw blade must be between 3 and 8 mm.

	<p><i>If the riving knife is missing or incorrectly adjusted, there is an increased risk of injury!</i> Please also observe the hazard warnings in the section → 5.5.2.</p>
---	--

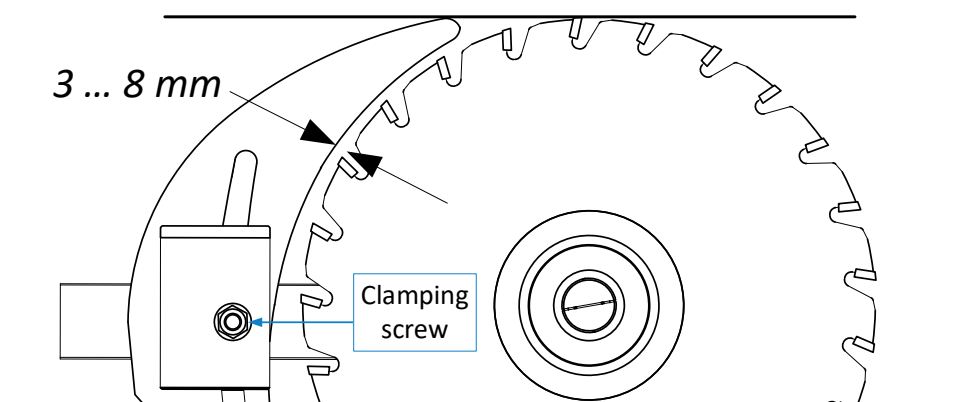

Figure 49: Riving knife setting (symbolic representation)

1. Loosen the clamping screw on the riving knife holder
2. Push the riving knife to the desired position
3. Tighten the clamping screw to fix the riving knife in place

The riving knife is adjusted in height by sliding it in its slot. The gap to the saw blade is adjusted by moving the entire holder on the rail.

The riving knife supplied with the machine is suitable for saw blades with diameters of 250 - 450 mm.

The diameters indicated correspond to the permissible diameter of the carbide saw blades.

16 Optional Components

16.1 Tele-Digit Cross-Cut Fence



Figure 50: Tele-Digit cross-cut fence

The Tele-Digit is an optional cross-cut fence for PANHANS sliding table saws, which is used instead of the standard cross-cut fence. A separate measuring system is integrated for each of the two flip stops. This allows two separate settings of both flip stops. The stop positions are visualised via a wireless digital display. Dust-insensitive magnetic measuring systems with non-contact scanning are used to determine the position.

16.1.1 Features

- Two non-contact, dust-insensitive magnetic measuring systems for separate position measurement for each flip stop
- Wireless digital indicator (0.1 mm) with battery operation
- Cutting lengths up to 3000 mm possible

16.1.2 Installation

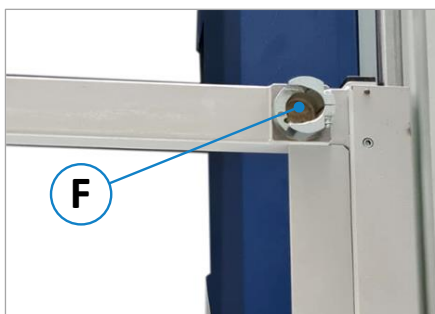

Figure 51: Fixing points on the cross slide

The Tele-Digit unit is fixed for 90° cuts completely without tools via the fixing points (F) of the cross slide at the desired position (left or right on the cross slide).

For angle and mitre cuts in combination with the optional mitre fences Super Gehrfix I or II, the Tele-Digit cross-cut fence is fixed in the center of the cross slide. For more information on the Super Gehrfix I and II, refer to the operating manual of your machine.

16.1.3 Tele-Digit Components

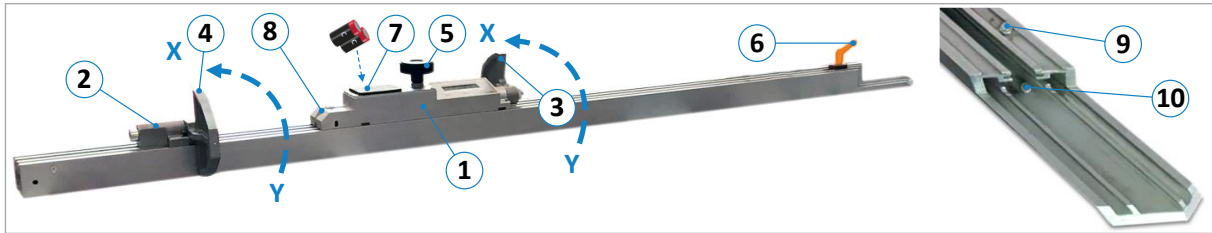

Figure 52: Tele-Digit components

No.	Description	No.	Description
1	Slider	6	Clamping lever "Pull-out"
2	Pull-out	7	Cover for battery compartment
3	Flip stop "Slider" >	8	Fine adjustment wheel
4	Flip stop "Pull-out" <	9	End stop screw "Slider" <
5	Clamping screw "Slider"	10	End stop screw "Pull-out" >

16.1.4 Digital Indicator

Pos.	Description
A	Switchover Slider or Pull-out
B	Function key (depending on mode)
C	Function key (depending on mode)
S	Symbols Slider 1 / Pull-out 2 active

Figure 53: Digital indicator

16.1.5 Length Measurement Switching

Switching between the two length measurements 1 (slider) and 2 (pull-out) is done with button A.

→ The currently active length measurement is shown in the top line of the LCD display.

16.1.6 Calibrate Tele-Digit

- Move the pull-out (3) all the way to the right against the end stop screw (10) and clamp it with lever (6).
- Move slider (1) all the way to the right against end stop screw (9) and clamp with clamping screw (5).
- Open battery compartment (7) and remove one of the batteries (power supply off).
- Now reinsert the battery (power supply back on).
→ The system now automatically calibrates itself and the stored reference dimensions appear again.
- The calibration procedure is completed.

For checking purposes, you can now perform test cuts for both flip stops at any position and check the cut dimensions for consistency. If there are any dimensional deviations, the reference values for the flip stop positions must be redefined (procedure see chapter ⇨ 16.1.8).

16.1.7 Battery Change

The indicator is powered by two 1.5 V size C batteries.



Fire, explosion and burn hazard! Never recharge batteries or expose them to temperatures above 85° C. Please dispose of the used batteries properly.

- Move the pull-out (3) all the way to the right against the end stop screw (10) and clamp it with lever (6).
- Move slider (1) all the way to the right against end stop screw (9) and clamp with clamping screw (5).
- The display now shows the stored reference dimensions for the end stop positions of both flip stops. Slider/pull-out switchover is performed with button A → Make a note of these two values.



The slider and the pull-out must not be moved during the battery change. Otherwise the dimensions will change and both flip stops will have to be recalibrated!

- Open the battery compartment (7) shown in ⇒ Figure 52 and replace the two batteries.
 - After the battery change, the unit automatically switches back on.
 - The indicator calibrates itself to the stored reference dimensions for the end stop positions.
 - The stored reference dimensions for the two end stop positions appear again.
- If the end stop positions deviate from the values before the battery was changed, the unit must be recalibrated (procedure see following chapter ⇒ see chapter ⇒ 16.1.8).

16.1.8 Set & Change Reference Dimensions

The reference dimensions are usually determined at the end stop positions (9) and (10) at the factory and are stored in the unit. To redefine or change them, proceed as follows:

- Move slider (1) all the way to the right against end stop screw (9) and clamp with clamping screw (5).
- Move the pull-out (2) all the way to the right against the end stop screw (10) and clamp it with lever (6).

16.1.8.1 Set Reference Dimension for Slider

- Move flip stop (3) to position X for slider (1) (see ⇒ Figure 52)
- Measure the distance between the saw blade and the flip stop (2) to the nearest 0.1 mm.

Enter measured dimension:

- Select the “slider” with button A (see ⇒ Figure 53):
 - The symbol (S) for the active slider (1) appears in the top line of the display.
- Press buttons C + B simultaneously
 - “oFS” for “offset” appears
- Press button C once
 - The stored reference dimension appears and the currently changeable digit flashes.

Note: If a minus sign is flashing here, then first switch to + with button B, so that the minus sign is hidden (+ is not shown in the display).

- Select the digit to be changed with button C → The 2nd digit of the display flashes.
- Now set the desired numerical value by pressing button B.
- Select the next digit with button C and set the value again with button B, and so on → until the measured dimension is completely entered.
- Then press button C repeatedly until the display exits the calibration mode
 - The message “-Sto-” appears briefly for confirmation.

16.1.8.2 Set Reference Dimension for Pull-Out

- Move flip stop (4) for pull-out (2) to position X
- Measure the distance between the saw blade and the flip stop (4) to the nearest 0.1 mm.

Enter measured dimension:

- Select the “pull-out” with button A (see ⇨ Figure 53):
The symbol (S) for the active pull-out (2) appears in the top line of the display.
- Enter the measured dimension as described in section ⇨ 16.1.8.1.

When the measured reference dimensions are set, perform test cuts and check the cut dimensions again. Repeat the calibration procedure in case of dimensional deviations.

16.1.9 Sleep-Mode

If the Tele-Digit is not needed for a longer period of time (e.g. over the weekend), the digital indicator can be set to sleep mode to save the batteries.

- To do this, clamp both flip stops and press the B + A buttons simultaneously for approx. 3 seconds.
→ The display briefly shows “OFF” and then switches off.
- To switch the display on again, press button A.

	<p>Please note that both flip stops are in clamped state. If one of the flip stops is moved during the sleep-mode, the current position will be lost and the system must be recalibrated (chapter ⇨ 16.1.6).</p>
---	---

16.1.10 Fix Error Message “FULL”

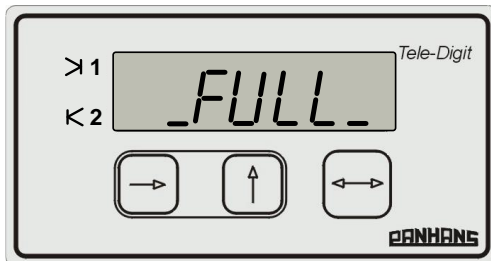

Figure 54: Error message FULL

If the error message “_FULL_” appears in the display, it can be remedied as follows:

- Clamp both flip stops so that they cannot be moved.
- Open the battery compartment (7) and remove one of the batteries (power supply off).
- Press buttons C + B + A simultaneously and reinsert battery (power supply back on).
- The display must show “SET-UP”.
- Press the left button C for 11 times → The error message should now be cleared.

16.2 Rip Fence left to the Saw Blade

For cutting long, narrow parts such as cupboard doors, the machine can be equipped with a “rip fence to the left of the saw blade”.

Structure and operation:

- Move the cross-cut fence to the desired length (max. 800 mm) and fix it in the rearmost position of the cross slide and slide table.
- Place the rip fence on the slide table and insert it into the intended fastening groove (A) and guide rail (B).
- Move the rip fence into position and clamp it using the toggle clamp lever (C).

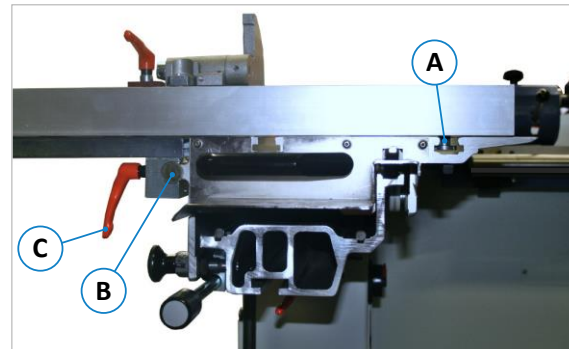

Figure 55: Rip fence mounted to the left of the saw blade

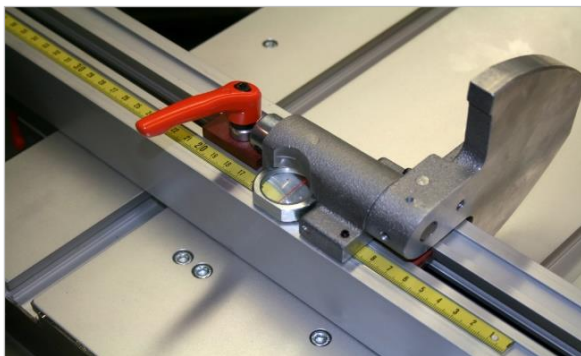

Figure 56: Flip stop (left to the saw blade)

- Move the flip stop on the rip fence to the dimension previously set on the cross-cut fence (⇒ Figure 56).
- Fix the stop plate by means of the toggle clamp lever.

Dismounting takes place in reverse order.

16.3 Double-sided Mitre Fences DSG-A and DSG-D

With the double-sided mitre fences DSG-A and DSG-D, all tasks can be carried out quickly and variably when making mitre cuts on narrow and short workpieces. Incorrect mitres can be quickly and easily calculated and precisely set using the additional angle factor scale. Both types have length compensation for preferred angles 5/10/15/22.5/30/45/60/67.5° and are suitable for cutting to lengths up to 1375 mm.



Figure 57: DSG-A (analogue)



Figure 58: DSG-D (with digital indicator)

- **DSG-A** (Linear and angular measure = analogue) → Art. No. 4379
For operation and settings, see separate operating manual ☞ [BA_ST_DSG-A_EN](#)
- **DSG-D** (Linear measure = analogue, angular measure = digital) → Art. No. 4380
For operation and settings, see separate operating manual ☞ [BA_ST_DSG-D_EN](#)

16.4 Cross-Cut & Mitre Fence Super Gehrfix I

The combined mitre and cross-cut fence Super Gehrfix I is suitable for angle cuts from 45° to 135°. Whole degrees and intermediate degrees are available for the angles 67.5/78.75/101.25/112.5°. Automatic length compensation takes place via a stainless steel grid curve.

	<p>To use the Super Gehrfix I it is mandatory to use a saw blade with a thickness of 3.2 mm.</p>
---	---

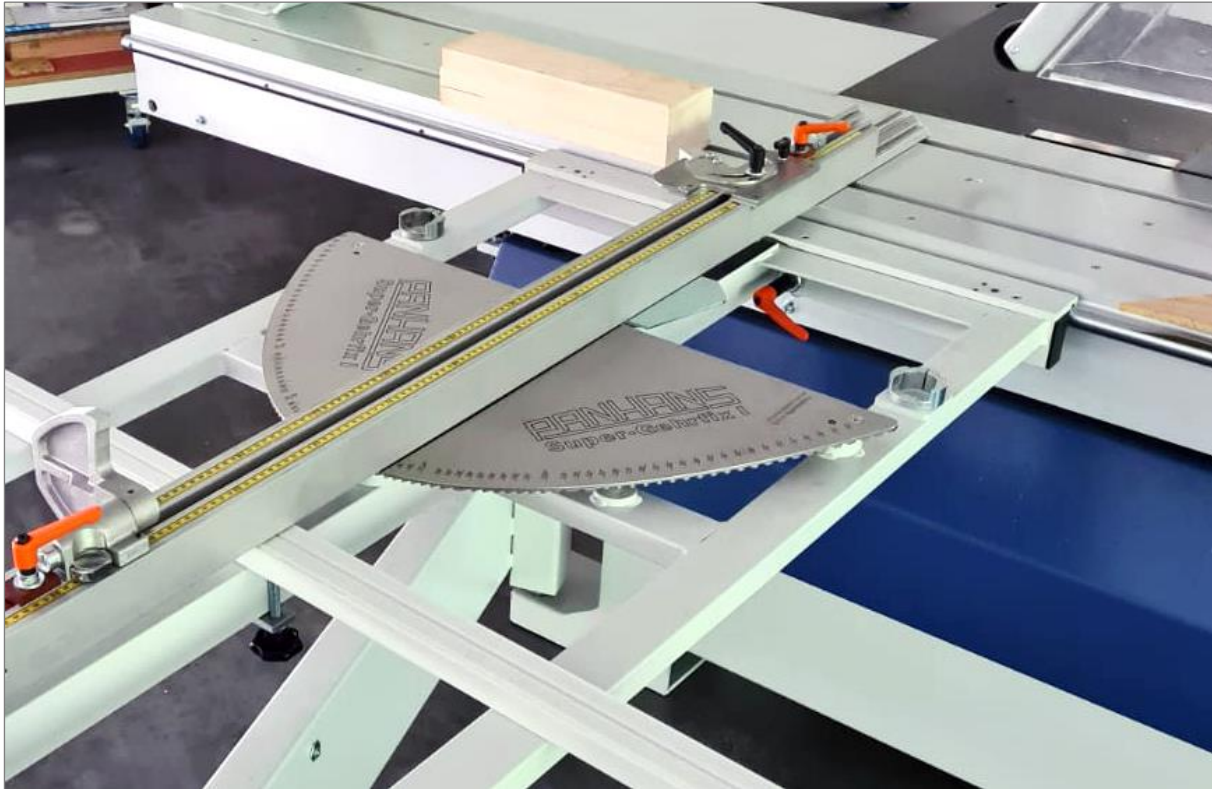

Figure 59: Super Gehrfix I

16.4.1 Features

- Allows infinite adjustment of the mitre angle
- Whole degrees and intermediate degrees adjustable
- Fixing points for 90° angles at the front and rear of the cross slide
- Automatic length compensation via grid curve
- Can be combined with the standard cross-cut fence or the optional Tele-Digit
- Art. No.: 4315

16.4.2 Super Gehrfix I Operation

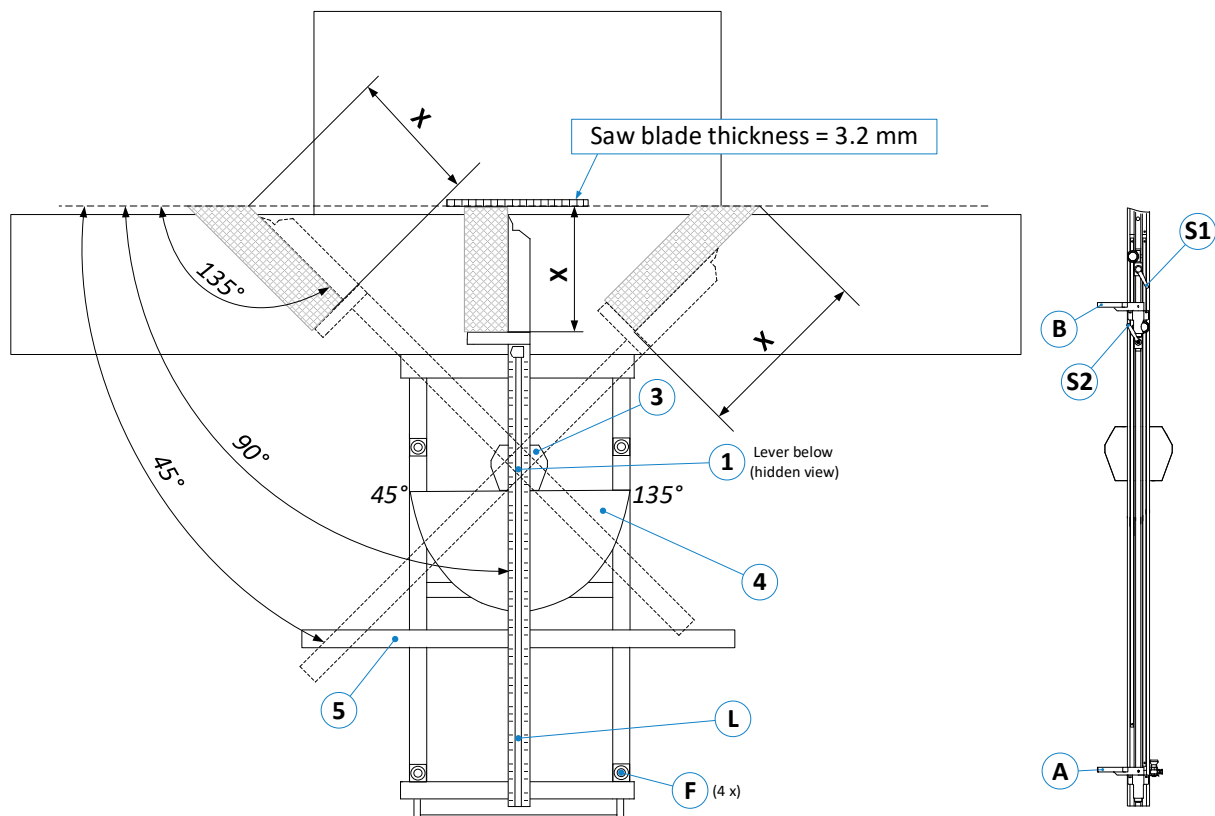

Figure 60: Super Gehrfix I overview

16.4.3 Attach Cross-Cut Fence

The crosscut fence is mechanically connected to the Super Gehrfix I via the locating pin (2), which is located in the slotted hole for the length compensation.

The procedure is very simple:

- Loosen clamping lever (1) and push the locating bolt (2) in the direction of the stop plate (P) as shown in ⇒ Figure 60 and ⇒ Figure 61.
- Now place the cross-cut fence (L) on the cross slide so that the locating pin (2) can be inserted into the receptacle (X) on the underside of the stop plate (3).
- Then tighten the clamping lever (1) again.

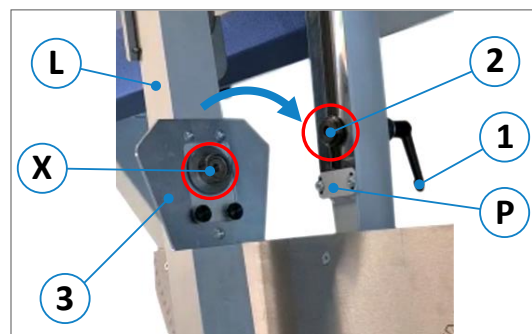

Figure 61: Attach cross-cut fence

16.4.4 Set Length > 1885 mm

- Loosen flip stop (A) with (S1), set to 1885 mm using magnifying glass and clamp with (S1).
- Loosen flip stop (B) with (S2), move to the desired position and clamp with (S2).

16.4.5 Set Angle to 90 Degrees

For 90° cuts, the cross-cut fence (L) can be used in different positions:

- Via the fixing points (F) on the left or right of the cross slide. To do this, simply release clamping lever (1) lift off the cross-cut fence (L) completely and insert it into the desired fixing points (F).
- Via the grid scale of the Super Gehrfix I (procedure see section ⇒ ⇒ 16.4.6).

16.4.6 Setting Degrees & Intermediate Degrees



For mitre cuts, the cross-cut fence (L) must always rest on the support rail (5) .

- Loosen the clamping lever (1).
- Then turn the cross-cut fence (L) and approach the desired angular dimension on the grid scale via the slotted hole for length compensation → Let it engage at the corresponding angular position.
- Tighten the clamping lever (1) again.

16.5 Cross-Cut & Mitre Fence Super Gehrfix II

The combined cross-cut fence and mitre fence "Super Gehrfix II" enables precise angular cuts from 45° to 135° without changing the dimension set on the cross-cut fence. The angle is set via a digital indicator and the automatic length compensation via a grid curve made of stainless steel.



To use the Super Gehrfix I it is mandatory to use a saw blade with a thickness of 3.2 mm.

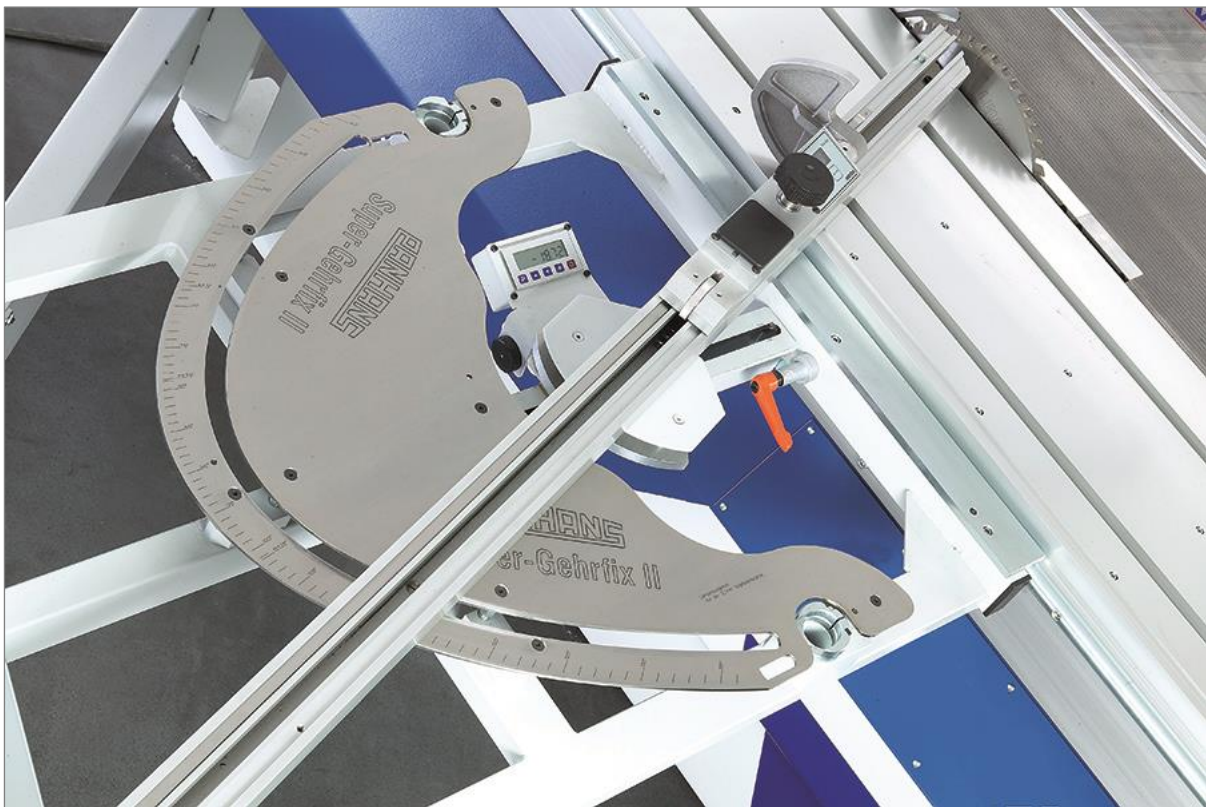

Figure 62: Super Gehrfix II

16.5.1 Features

- Allows infinite adjustment of the mitre angle
- Battery-operated digital indicator included
- Infinitely adjustable and readable to 0.1
- Fixing points for 90° angles at the front and rear of the cross slide
- Automatic length compensation via grid curve
- Setting accuracy: 1/100°
- Can be combined with the standard cross-cut fence or the optional Tele-Digit
- Art. No.: 4303

16.5.2 Components & Overview

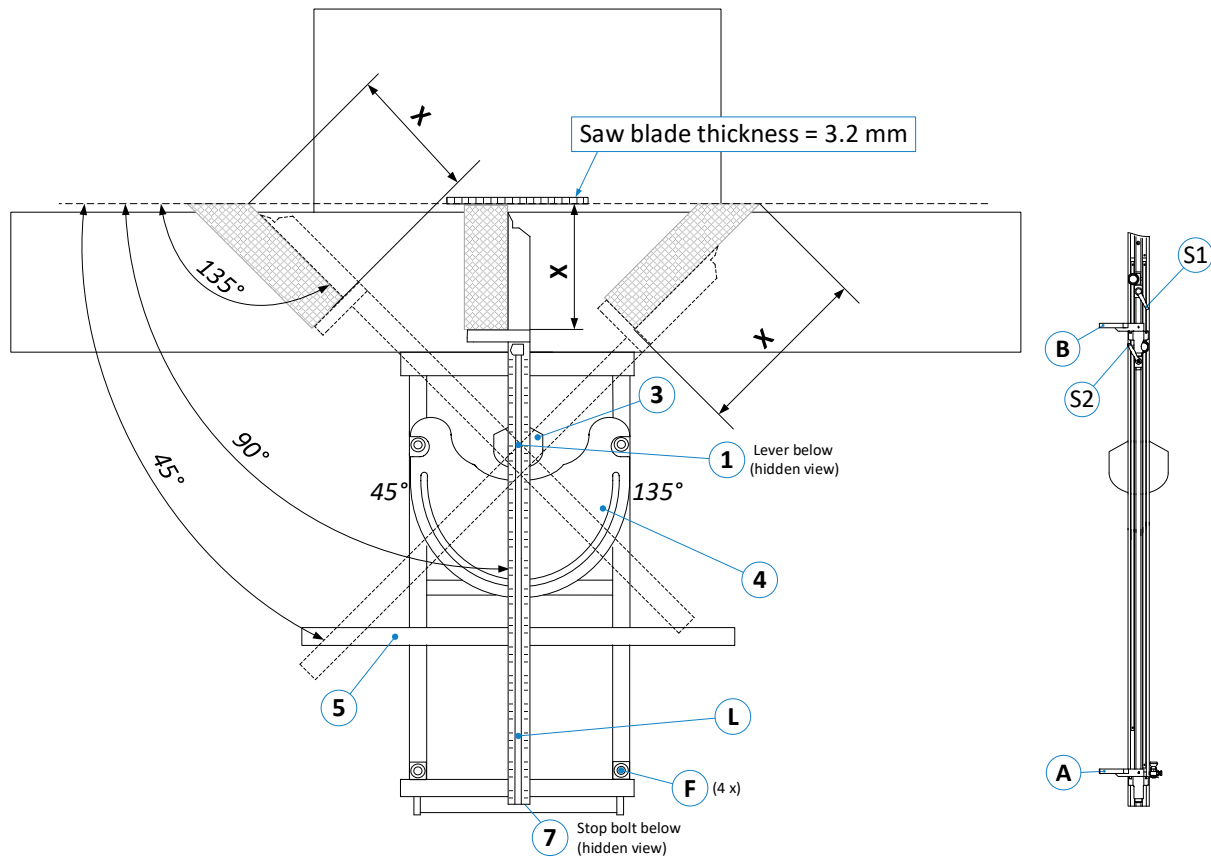



Figure 63: Super Gehrfix I overview

16.5.3 Calibrate Super Gehrfix II

To calibrate the Super Gehrfix II, it must first be positioned at 90° using the stop bolt (7) as shown in the illustration above. Then press the button  on the digital display to complete the calibration procedure.

➔ After successful calibration, the value 0.00° appears in the digital display.

16.5.4 Attach Cross-Cut Fence

- Tighten the clamping lever (1) on the cross-cut fence (L) to fix the fixture.

16.5.5 Set Length > 1885 mm

- Loosen flip stop (A) with (S1), set to 1885 mm using magnifying glass and clamp with (S1).
- Loosen flip stop (B) with (S2), move to the desired position and clamp with (S2).

16.5.6 Set Angle to 90 Degrees

For 90° cuts, the cross-cut fence (L) can be used in different positions:

- Via the fixing points (F) on the left or right of the cross slide. To do this, simply release clamping lever (1) lift off the cross-cut fence (L) completely and insert it into the desired fixing points (F).
- In the center of the cross slide, using the stop bolt (7) for calibration (procedure see section ⇨ 16.5.5).

16.5.7 Setting Degrees & Intermediate Degrees



For mitre cuts, the cross-cut fence (L) must always rest on the support rail (5) .

- Loosen the clamping lever (1).
- Then turn the cross-cut fence (L) and set to the desired angle via the digital display.
- Tighten the clamping lever (1) again.

16.5.8 Changing Parameters of the Digital Indicator

- Press button **P** until parameter “**AUFL**” appears.
- Press button **↑** to scroll through the parameters until the parameter to be changed appears.
- Using the arrow keys, enter the parameters according to the parameter table (see below) and confirm by pressing button **+**.
- Press **P** a total of 15 times until the parameters have been exited.
- 🗑️ **Switch the unit off and on again so that the changes are applied!**

Display	Designation / Value Range	Basic Setting	PANHANS Setting
AuFL	Resolution (mm, In = Inch) 1, 0.1, 0.05, In 0.01, In 0.001, FrEI, 1/16in, 1/32in, 1/64in	0.1	FrEI
FAc	Multiplicator (only with resolution “FrEI”) 0.0000 ... 9.99999	0.00000	Standard 0.57160
dP	Decimal places (only with resolution “FrEI”) 0 ... 0.000	0.00	0.00
rEF	Reference value -99999 ... (+)99999	00000.0	
oFS	Offsetwert -99999 ... (+)99999	00000.0	
ZAEhL	Counting direction UP, DOWN	UP	
Auto	Switch-off type OFF, ON	OFF	OFF
PEriod	Switch-off time (in hours) (only with switch-off type = ON) 0.2, 0.5, 1.0, 2.0, 4.0, 8.0	0.2	
ISP	Actual value memory ON, OFF	OFF	OFF
4_off	Switch off delay ON, OFF	OFF	OFF
F_ABS	Enable reset function ON, OFF	ON	ON
F_REL	Enable incremental mode ON, OFF	OFF	OFF
F_REF	Enable change of reference value ON, OFF	OFF	OFF
F_OFS	Enable change of offset value ON, OFF	OFF	OFF
SPR	Language (D = German / E = English)	D	D

More details about the unit on <https://www.siko-global.com/en-de/service-downloads/download-products?A=detail&id=1440>

16.6 Auxiliary Mitre Fence for Super Gehrfix

The auxiliary mitre fence is an additional fence to the existing cross-cut fence.

The unit can be combined with the cross-cut and mitre fences "Super Gehrfix I" (⇒ 16.4) and "Super Gehrfix II" (⇒ 16.5). It allows easy adjustment of the length when producing acute and obtuse angles.

The device is used to stop and cut mitres to length without damage and has an adjustable angle and a fixed offset of 100 mm to the flip stop.



Figure 64: Auxiliary mitre fence

By using this auxiliary fence, the length dimension of a workpiece cut at an angle is already automatically correct (exactly as if it would be cut straight at the standard right-angled flip stop).

16.6.1 Operating the Auxiliary Mitre Fence

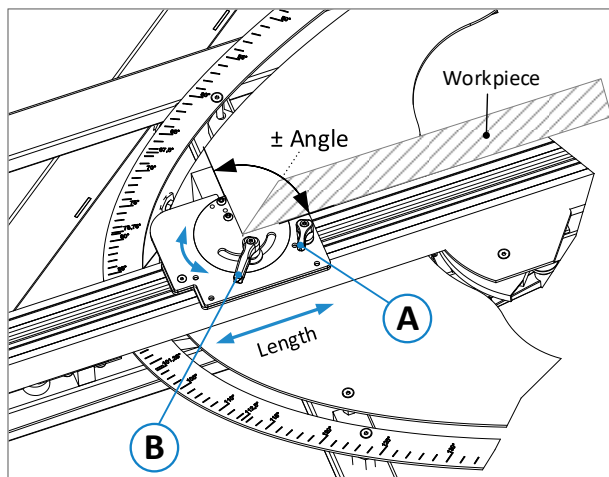

Figure 65: Operating the auxiliary mitre fence

The auxiliary fence has two clamping levers:

1. Clamping lever (A) is used to fix the fence in the groove along the guide unit.
2. After loosening clamping lever (B), the device can be rotated to adjust the desired angle of the workpiece.

16.7 Standard Mitre Fence

The optionally available standard mitre fence is fixed to the slide table by a clamping lever and can be swivelled on both sides. It has a degree scale from 45° to 60° in the slide table groove and is equipped with an extendable cross-cut fence up to 2000 mm and a flip stop.

Functionality:

With the additional angle scale in the groove of the slide table, the angle degrees to be set can be read off.

- To do this, loosen the clamping lever in the slotted hole of the angle plate and move the stop to the desired position. Then tighten the lever again and release the cut.
- The other clamping lever is used to set the cross-cut flip stop.

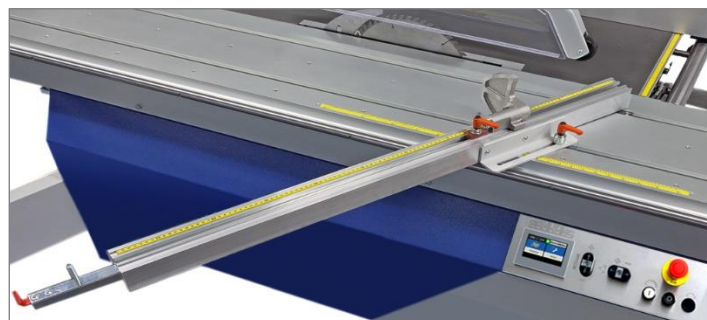

Figure 66: Standard mitre fence

16.8 Digit PAB - Absolute Measuring System for the Rip Fence



Figure 67: Digit PAB

The Digit-PAB is a cordless, battery-operated absolute measuring system for the manually adjustable rip fence.

The current position value is visualised via an easy-to-read digital display, which is housed in a swivelling housing on the rip fence.

Due to the absolute measuring sensor, the rip fence does not need to be calibrated additionally, even if it has been swivelled under the table. The fence position can be finely adjusted with an accuracy of 0.1 mm.

16.8.1 Digit-PAB Features

- Due to exact measurement repetitions of 1/10 mm, higher dimensional accuracy than a scale
- Dust and dirt insensitive, magnetic absolute measuring system with contactless scanning
- Swivelling range of the display housing 45° for an optimal view in every working position
- No calibration required, even when the fence is swivelled under the table
- Measurements and parameters are not lost when batteries are changed
- No disturbing power supply cables in the fence area
- Life of the 1.5 volt baby cell approx. 3 years
- Large, easy-to-read LCD display
- Quick and easy battery change

16.8.2 Digit PAB - Operation

- If the rip fence is folded under the table, the display shows “**noCode**”. This means that the magnetic sensor no longer has contact to the magnetic tape and cannot record any measured values.
- As soon as the fence is folded into its working position, the correct position appears in the display.

16.8.3 Digit PAB – Rip Fence Capacities

The absolute measuring system with digital display is available for different rip fence capacities:

1. Standard rip fence capacity 1030 mm
→ **Art. No. 4755**
2. Optional rip fence capacity² 830 mm
→ **Art. No. 4754**
3. Optional rip fence capacity³ 1280 mm
→ **Art. No. 4756**

See also "Accessories" in the section  19.3.

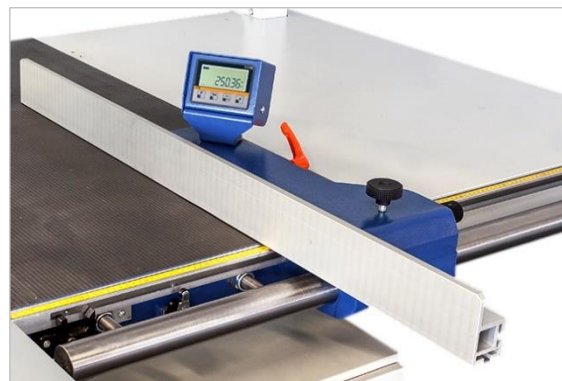



Figure 68: Rip fence with Digit-PAB

² Only available with option “Rip fence capacity 830 mm” (Art. No. 4752).

³ Only available with option “Rip fence capacity 1280 mm” (Art. No. 4753).

16.9 Power Feeder 76

The circular saw power feeder 76 (Art. No. 2078) is the ideal addition to your sliding table saw. It ensures additional safety and ergonomic working when cutting battens, planks, window scantlings and other workpieces made of solid wood. It is simply pushed onto the rip fence holding block (1) via the guide rail instead of the standard rip fence rail and fixed via the clamping lever.

	To prevent an interruption of the emergency stop chain, this option is only available in combination with the option "Machine Socket" (Art. No. 4211, see ⇨ 19.6).
---	---

For power supply, the machine plug is simply plugged into the optional machine socket.

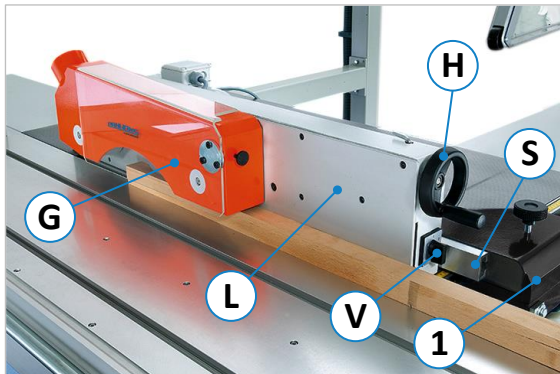

Figure 69: Power feeder 76

Pos.	Description
1	Rip fence holding block
S	Rail for mounting
H	Handwheel for height adjustment
V	Rotary switch ON / OFF / FEED RATE (0 = OFF 1 = 13 m/min 2 = 26 m / min)
L	Stop plate for cutting width adjustment
G	Housing with rollers and protective cover

Features:

- With adjustable pick-up profile, 3 rollers and 2 feed rates
- Quick adjustment of the workpiece height via handwheel
- With suction port for dust-free working
- With rail for mounting height of 18 - 40 mm
- Integrated electrical magnet system to prevent tipping
- Tool-free quick assembly/disassembly on the rip fence instead of the conventional standard aluminium profile
- Optimum view of the workpiece due to transparent, swivelling protective cover
- Ergonomic work when cutting battens
- Power supply 400 V / 50 Hz (including machine plug)

Technical Specifications:

Driving rollers	3 pieces
Rollers ø	110 mm
Front roller thickness	50 mm
Centre roller thickness	20 mm
Rear roller thickness	50 mm
Axle distance	200 mm
Feed rates	13 + 26 m/min
Dive motor	0,14 kW
Workpiece height	min. 80 mm
Workpiece length	min. 200 mm
Cutting width	min. 25 mm
Suction nozzle ø	80 mm
Net weight	approx. 30 kg

16.9.1 Mounting the Power Feeder



Figure 70: Mounting the power feeder

1. Release the lever (2) and pull out the standard stop rail (4).
2. Push the power feeder onto the rail (S).
3. Pull back to above the mm scale and clamp with lever (2).
4. The cutting width (min. 25 mm) is set manually via the millimetre scale on the table. Workpieces < 25 mm cannot be machined as they are too narrow for the centre roller.
5. Set the height of the feeder to the thickness of the workpiece and lower it approx. 3 mm to apply pressure.

16.10 Adjustable Scoring Saw Blade “QuickStep”

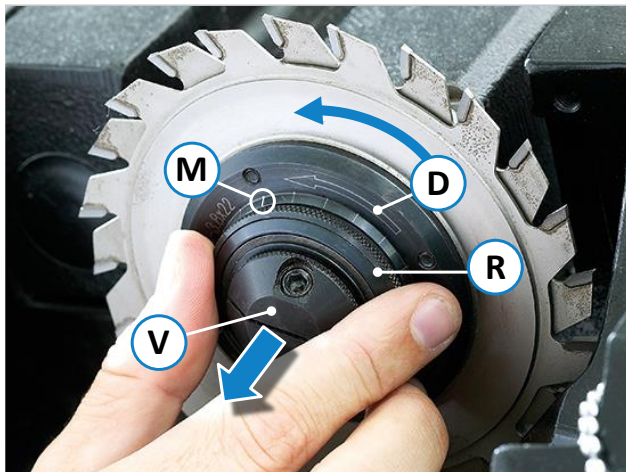

Figure 71: Quickstep setting mechanism for scoring saw blade

Technical Specifications of the scoring saw blade

Art. No. 4550	
Speed range:	8000 - 12100 rpm
Saw blade:	Ø 125 mm
Setting range:	2.8 – 3.8 mm
Raster:	0,05 mm
Flange:	Ø 70 mm
Drilling:	Ø 22 mm



When not in use, the outer scoring saw blade may have play. During operation it is tensioned by centrifugal force.

16.10.1 Setting the scoring width

Pull the knurled screw (R) of the clamping flange forward (V) and turn it.

↺ **Counterclockwise** → Cutting width increases

↻ **Clockwise** → Cutting width decreases

An adjustment of the knurled screw by one raster (= one mark “M”) corresponds to an adjustment of the scoring width by 0.05 mm.

Example: The dimension 3.10 mm is to be set.

1. Measure cutting width (with test cut)
2. Measured dimension = 3.00 mm
3. Pull the knurled screw (R) of the mechanism forwards (V), turn it to the left by 2 markings (M) and let it engage.
4. Check the cutting width (with test cut)

16.10.2 Changing the Scoring Saw Blade



Work at the saw blades must always be carried out with extreme care. There is an increased risk of injury due to the very sharp cutting edges! Protective gloves must be worn when changing saw blades!

Removal:

- Dismantle the clamping screw and remove the scoring saw setting mechanism.
- Pull the knurled screw (R) of the clamping flange forwards (V) and turn it several revolutions (approx. 5) to the left until the front saw blade can be turned freely.
- Engage the knurled screw and unscrew the front flange.
- Remove the screws on the inside (4 each) with a 2.5 mm pin spanner and take out the saw blade.

Installing:

- Clean all parts thoroughly.
- Insert the saw blades into the bolts on the flanges, observing the direction of rotation (**D**), see ⇒ Figure 71.
- Screw in and tighten the screws (4 per flange).
- Screw the flanges together until the saw blades touch; for the (approx. 5) last turns pull the knurled screw forward.
- The saw teeth must be behind each other and in the direction of rotation (**D**). The knurled screw (**R**) must be correctly engaged.
- Place the setting mechanism onto the motor shaft, screw in the clamping screw and tighten it by hand. To do this, use the QuickStep quick-release screw (see the following Figure).

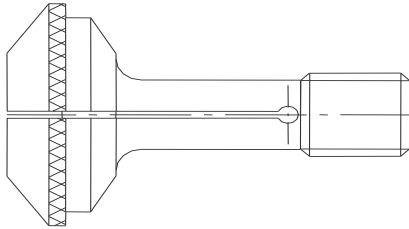

Figure 72: Quickstep quick-release screw

- Tighten the grub screw of the clamping screw with a torque of 12 Nm.
- Close the sawdust flap.
- Determine blade thickness by test cuts and readjust if necessary.

16.11 Manual Scoring Unit 1750



Work at the saw blades must always be carried out with extreme care. There is an increased risk of injury due to the very sharp cutting edges! Protective gloves must be worn when changing saw blades!

- Switch off the main switch and secure it with a padlock to prevent it from being switched on again unexpectedly.
- Move the slide table to the left as far as it will go. By pressing the safety catch (see ⇒ Figure 46), the slide table can be moved beyond the stop for changing the saw blade.
- Open sawdust flap.
- Turn the saw shaft by hand until the grub screw of the clamping screw is at the top.
- Loosen the grub screw with an SW 4 pin spanner.
- Unscrew the clamping screw by hand (right-hand thread) and remove it together with the flange.

Insert scoring saw blade:

- Clean the flange and saw blade.
- Insert new scoring saw blade and observe the direction of rotation!
- Put on the clamping screw with flange and tighten it by hand.
- Tighten the grub screw of the clamping screw with a torque of 12 Nm.
- Close sawdust flap.

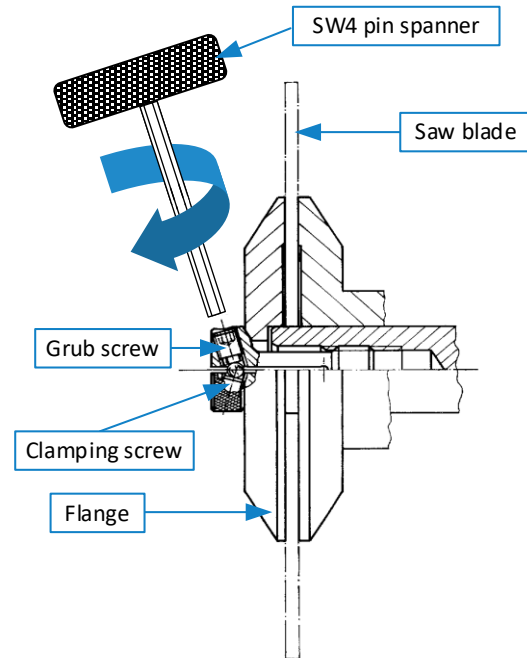

Figure 73: Saw blade flange of the scoring saw

We generally recommend the use of two-piece scoring saw blades, which are brought to the required blade thickness by placing spacers between them. The kerf of the scoring saw blade should be approx. 0.1 mm wider than that of the main saw blade, i.e. 0.05 mm to each side.

Caution: Only \varnothing 125 mm scoring saw blades may be used.

Important: If a saw blade with a diameter > 350 mm is used, the scoring saw blade must be removed and the **safety catch** at the sawdust flap must be swivelled to the right.

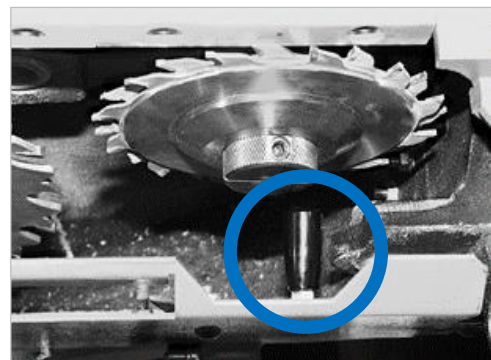

Figure 74: Safety catch of the sawdust flap

The scoring saw blade is adjusted using the two front located setting wheels (see section ⇒ 16.11.1).

16.11.1 Adjusting the manual scoring saw

On machines with manual scoring unit 1750 (option), the scoring saw is adjusted using the setting wheels shown in the figure. These are located on the front of the machine.

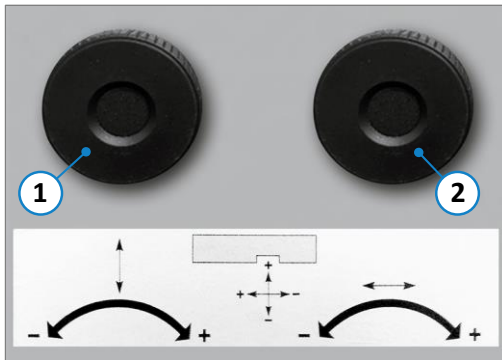

Figure 75: Setting wheels for scoring saw

- **Height adjustment:**
Adjust the desired height using the setting wheel (1)
- **Lateral adjustment:**
Adjust the desired position using the setting wheel (2)

16.12 Spraying System

For certain applications (e.g. when processing aluminium profiles or composite materials with aluminium content), the machine can be equipped with a spraying system (minimum quantity cooling lubrication). This can be ordered under Art. No. 4324.

16.12.1 Special features when using a spraying system

	<p>When working with the spraying system, it is essential to wear oil-resistant gloves, closed, tight-fitting clothing and protective goggles.</p>
--	---

If the machine is operated with a spraying system, special care must be taken to ensure adequate extraction. Under certain conditions, harmful substances can be generated in the spray mist.

	<p>There is a health hazard for the lungs and respiratory tract due to the spray mist. Therefore wear a suitable respiratory mask.</p>
--	---

The manufacturer's operating instructions for the spraying system must be observed.

Spray lubricants recommended for aluminium machining: see enclosed sheet from the manufacturer.

16.13 Laser Cut-Position Indicator

As an additional positioning aid for the workpiece, the sliding table saw can be equipped with a laser cut-position indicator (Art. No. 4322).

This is particularly useful for visually indicating the kerf on scribe marks or for trim cuts, e.g. for board material with a forest edge.

The laser is mounted on the guard of the machine (see figure on the right) and is activated by means of a switch on the control panel.

The laser class is 2.



Figure 76: Laser cut-position indicator

16.14 Trimming with Laser Beam

To trim the workpiece as loss-free as possible, simply push it to the right until the edge to be trimmed is completely behind the laser beam. Then release the cut.

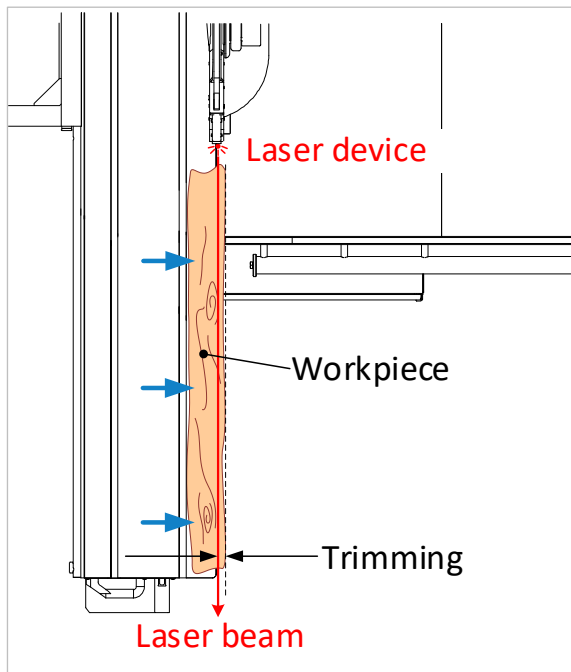



Figure 77: Trimming with laser beam

16.15 Special Requirements for Use

The laser device must be adjusted in such a way that it is not possible to look directly into the laser beam. It should also be noted that the laser beam can be reflected from reflective surfaces (e.g. the machine table or other blank parts).

	<p>Warning: Looking directly into the laser beam causes serious eye injuries!</p>
---	--

	<p>The operating instructions of the laser manufacturer must be observed.</p>
---	--

16.16 Swivel-Away Device for the Cross Slide

For some operations it may be necessary to remove the cross slide. For this purpose, the optional swivel-away device available under Art. No. 4770 is a useful aid.

16.16.1 Attaching the swivel arm to the cross slide

- Lock slide table (**W**) in middle position.
- Set the cross-cut fence (**L**) on the left-hand side to 90°.
- Move the movable support widening (**5**) all the way to the left.

For the next steps, stand on the left side to the end of the slide table.

- Pull the swivel arm (**1**) under the cross slide (**Q**).
- Insert swivel arm support bolt (**2**) into the holding plate (**4**) of the cross slide (**Q**). Then clamp with the clamping lever (**3**).

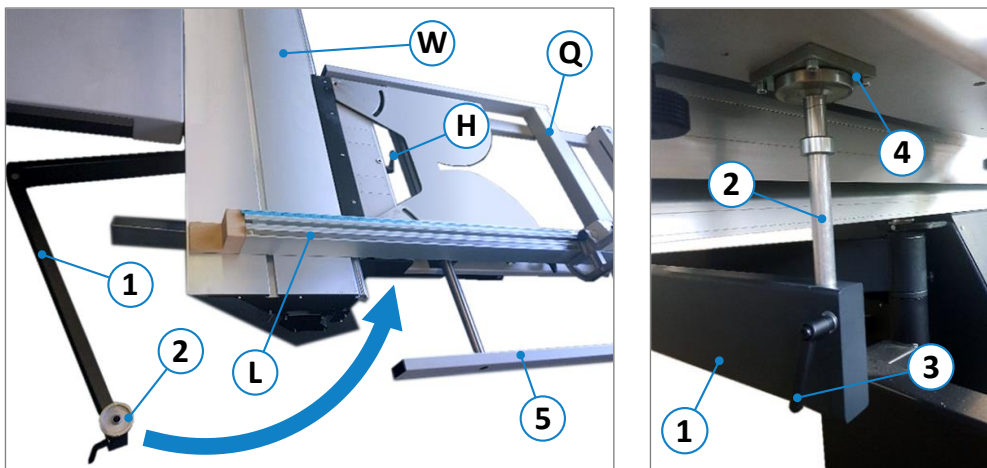

Figure 78: Position and mount swivel arm

- Loosen the clamping lever (**H**) and pull the cross slide (**Q**) forwards → The cross slide is now only supported by the swivel away arm (**1**) and the telescopic swivel arm (**S**).
- Turn the cross slide (**Q**) by 90° to the right. Then swivel it backward to bring it into its final parking position behind the slide table (see ⇒ Figure 79 and ⇒ Figure 80).

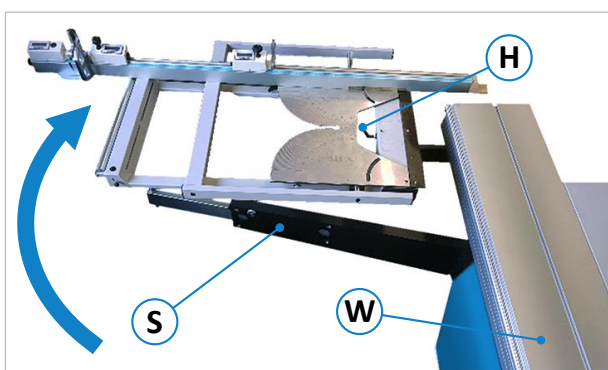

Figure 79: Swivel away cross slide

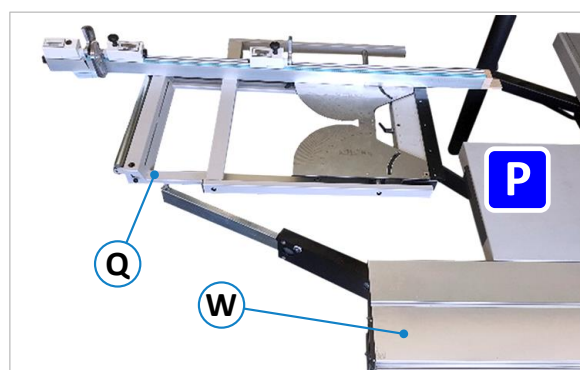

Figure 80: Final parking position

16.16.2 Reattaching the Cross Slide

- The cross slide is attached in the reverse order.
- If the swivel-away device is not used, it should be folded up at the machine stand.

17 Troubleshooting

Proceed systematically when searching for the cause of a malfunction. If you are unable to find the fault or to remedy the malfunction, contact our customer service department (phone number: 0049 7571 / 755 – 0).







Before you call us, please follow these steps:

- Make a note of the type, machine number and year of production (see nameplate).
- Keep this operating manual (and any circuit diagrams) to hand.
- Describe the fault to us in detail so that a competent remedy can be found.

Various faults are signalled by a corresponding message window is shown in the touchscreen (see also section ⇨ 17.1). For further information, select the  symbol on the touchscreen and/or observe the fault indicator A3 in the control cabinet. In the event of a fault, follow the instructions on the screen.

Fault	Possible Cause	Remedy
Machine does not start	No voltage	→ Check power supply
	Control fuse defective	→ Check fuse & replace if necessary (see circuit diagram)
	Overload protection tripped	→ Check F1 (see wiring diagram)
	Main switch defective	→ Replace main switch
	Drive motor defective	→ Replace motor
	V-belt breakage	→ Replace V-belt
	Machine stand door not closed	→ Close door
	Sawdust flap not closed	→ Close sawdust flap
	Slide table was moved to the left over mechanical stop	→ Move slide table to the right
Power supply unit G1 defective	→ Replace power supply unit	
Speed indicator shows nothing	Touchscreen unit defective	→ Contact customer service
	Fork light barrier defective	→ Replace fork light barrier
Speed indicator shows "Error"	Belt does not run in the speed fork	→ Refer to section ⇨ 17.2
	V-belt of the main saw torn	→ Replace V-belt
	Fork light barrier dirty	→ Clean fork light barrier
Sawing unit does not tilt out	Tilting segments resinous	→ Clean and lubricate with oil → Check fuse F4
Height adjustment runs sluggishly	Insufficiently lubricated	→ Lubricate
Height adjustment does not run	Fuse F4 has tripped	→ Check fuse F4
Swivel arm runs unsteadily	Rollers dirty	→ Clean rollers
Touchscreen shows nothing	Fuse F5 or F3 has tripped	→ Check fuses F3 and F5
	Power supply G1 defective	→ Replace power supply unit
Touchscreen is blurred, no entry possible	Malfunction or defective	→ Restart or contact customer service if necessary
Scoring unit does not start	Main saw does not run	→ Check fuse F2
		→ Start main saw

17.1 Fault Messages on the Touchscreen

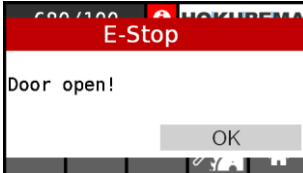
 <p>Figure 81: Error message 1</p>	<p>Message: E-Stop pressed!</p> <p>Cause:</p> <ul style="list-style-type: none"> • An emergency stop switch was actuated. <p>Remedy:</p> <ul style="list-style-type: none"> • Check the two emergency stop switches.
 <p>Figure 82: Error message 2</p>	<p>Message: Motor protection!</p> <p>Cause:</p> <ul style="list-style-type: none"> • Motor protection switch F1 or F2 has tripped. • Main motor or scoring motor overloaded. • Power supply unit G1 defective. <p>Remedy:</p> <ul style="list-style-type: none"> • Check fuses F1 / F2 and reset if necessary. • Check main motor and scoring motor. • Check power supply G1 and replace if necessary.
 <p>Figure 83: Error message 3</p>	<p>Message: Sliding table limit!!</p> <p>Cause:</p> <ul style="list-style-type: none"> • Slide table has moved all the way to the back. <p>Remedy:</p> <ul style="list-style-type: none"> • Move slide table to working position.
 <p>Figure 84: Error message 4</p>	<p>Message: Sawdust flap open!</p> <p>Cause: Sawdust flap is open or has opened by itself due to chips.</p> <p>Remedy: Close sawdust flap.</p>
 <p>Figure 85: Error message 5</p>	<p>Message: Fault brake device!</p> <p>Cause:</p> <ul style="list-style-type: none"> • Start / brake unit Q3 malfunction. • Main motor is overheated. • Circuit breaker F1 or F2 have tripped. • Unexpected fault in device Q3. <p>Remedy:</p> <ul style="list-style-type: none"> • Check fuses F1 / F2 and reset if necessary. • Allow main motor to cool down. • Check device Q3. • Error is cleared only after restarting the machine!
 <p>Figure 86: Error message 6</p>	<p>Message: Load voltage monitoring</p> <p>Cause:</p> <ul style="list-style-type: none"> • Fuse F4 has tripped • Axes jammed <p>Remedy:</p> <ul style="list-style-type: none"> • Check fuse F4 and reset if necessary • Eliminate jamming of the axes
 <p>Figure 87: Error message 7</p>	<p>Message: Door open!</p> <p>Cause:</p> <ul style="list-style-type: none"> • The rear door of the machine stand is still open or not properly closed <p>Remedy:</p> <ul style="list-style-type: none"> • Close the door

If you are unable to correct a fault using our instructions, or if the fault occurs repeatedly after you have corrected it, please call our customer service department on 0049 7571 / 755 - 0.

17.2 Retightening / Changing the V-belt



Before starting work, the main switch must be switched off and secured with a padlock against being switched on again unexpectedly.

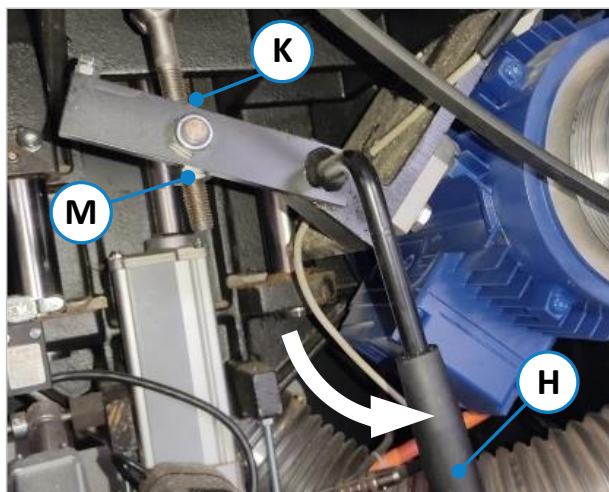

Figure 88: V-belt tightness

Procedure:

- First flip the lever (**H**) to release the tension of the V-belt.
- Then loosen the lock nut (**K**)
- Turn nut (**M**) slightly downwards
- Tighten lock nut (**K**) again and flip lever (**H**) again to tighten the belt

The belt is correctly tensioned when it can be pushed through approx. 10 mm between the belt pulleys at a lateral pressure of approx. 2 kg.

V-belts used:

Machine with manual V-belt shifting
5.5/7.5 kW / PK x 1000

18 Maintenance and Inspection

Before any maintenance and inspection work is carried out, chapter ⇒ **5 Safety** must be read carefully and observed!

Operational malfunctions caused by insufficient or improper maintenance can result in very high repair costs and long machine downtimes. Regular maintenance is therefore essential.

Due to the different operating conditions, it is not possible to determine in advance how often a wear check, inspection or maintenance is required. Inspection intervals are to be determined appropriately according to the respective operating conditions.

- Clean the machine daily.
- Check all sliding or rolling parts weekly for smooth running and lubricate with a thin-bodied oil if necessary.
- Remove and replace damaged parts. Never work with damaged parts!!
- Damaged guards, saw blades, clamping flanges, clamping nuts and riving knives must be replaced immediately. Never work with damaged parts!
- Clean the guideways of the sliding table monthly.
- Inspect electrical equipment/components weekly for externally visible damage and have them repaired by a qualified electrician if necessary.
- Check the extraction unit for full function daily before starting work.
- The extraction unit must be checked for obvious defects before initial commissioning, daily and monthly to ensure its effectiveness.
- The air velocity to the extraction system must be checked before the initial commissioning and after significant modification.
- Our specialists are at your disposal with further advice.
- Do not use the machine until these conditions are met.

18.1 Lubrication Guide

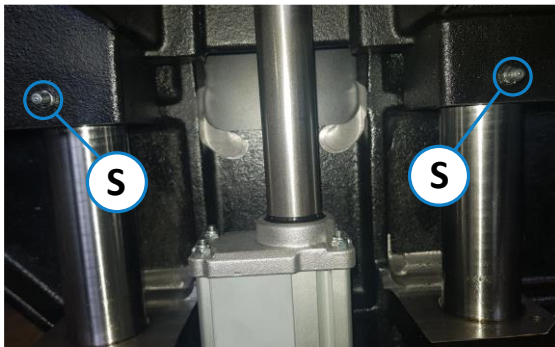

Figure 89: Lubrication points on the height adjustment

- Check all sliding or rolling parts weekly for smooth running and, if necessary, lubricate with a thin-bodied oil.
- Apply a few drops of oil to the threads of clamping and adjustment levers weekly.
- Lightly grease the support bolt of the cross slide every month between the bolt and the cross slide.
- Lubricate the two lubrication points (**S**) on the height adjustment of the sawing unit with 2 shots of grease every month.

19 Options and Accessories

19.1 Sawing Units

Article	Description	Art. No.
THREE-PHASE MOTOR WITH 7.5 KW (10 HP)	More powerful main saw motor, instead of the standard 5.5 kW motor.	4319
SCORING UNIT 1750 0.55 KW (0.75 HP)	With manual height and lateral adjustment via externally mounted handwheels with "APA" saw blade quick clamping system.	4078
SCORING SYSTEM QUICK-STEP	For manual scoring width adjustment without tools. From 2.8 to 3.8 mm through raster adjustment by 0.05 mm / single step, incl. 1 set of saw blades 125 x 2.8 - 3.8 x 50 mm Z = 12+12 for system Auto-EPS & 1750.	4550
SPARE CARBIDE SCORING SAW BLADE	125 x 2.8 - 3.8 x 50 mm. Z = 12+12 (set = 2 pieces) for the Quick-Step scoring system (see Art. No. 4550)	4551

19.2 Machine Operation

Article	Description	Art. No.
CONTROL PANEL AT EYE LEVEL	Placed at eye level and can be swivelled. Instead of at the bottom of the machine body.	4757
TEMPLATE HOLDER ON THE CONTROL PANEL	Top mounted with magnetic holder (only in combination with 4757).	4758

19.3 Optional Fence Systems

Article	Description	Art. No.
TELE-DIGIT CROSS-CUT FENCE	With central digital wireless indicator (accuracy 0.1 mm) for both flip stops (up to 3000 mm), instead of standard cross-cut fence.	4167
RIP FENCE LEFT TO THE SAW BLADE	For cutting long, narrow parts, easily adjustable via dimension scale and sliding flip stop with magnifying glass up to 800 mm cutting width.	4488
SUPER GEHRFIX I	Combined mitre / cross-cut fence with automatic length compensation; for angle cuts from 45° to 135° with V2a grid curve, graduation and intermediate degrees for 67.5°/78.75°/101.25°/112.5°; the standard cross-cut fence can be fixed to it (unit cannot be retrofitted).	4315
SUPER GEHRFIX II	Combined mitre and cross-cut fence, length adjustable via scale, for angle cuts from 45° to 135° with stepless angular adjustment via digital indicator (0.01°), with automatic length compensation; the standard cross-cut fence serves as cross-cut fence (unit cannot be retrofitted).	4303
AUXILIARY MITRE FENCE FOR SUPER GEHRFIX I + II	For damage-free cutting to length of mitres or hexagons that have already been cut to size on one side. Serves as an additional fence on the cross-cut fence. With adjustable angle for the pre-cut mitres and a fixed offset dimension of 100 mm.	4173
STANDARD CROSS-CUT FENCE	Swivelling on both sides, 45° - 60° with extendable flip stop up to 2000 mm length.	4592

Article	Description	Art. No.
DOUBLE-SIDED MITRE FENCE DSG A	For angle cuts 0° - 90° on the double slide table, length and angle measurement adjustable via scale; for cutting lengths up to 1375 mm, with length compensation for preferred angles 5°, 10°, 15°, 22.5°, 30°, 45°, 60°, 67.5°, incl. splinter block, wall bracket and an additional factor scale for easy calculation of wrong mitres for different workpiece widths.	4379
DOUBLE-SIDED MITRE FENCE DSG D	For angle cuts 0° - 90° on the double slide table, length measurement adjustable via scale, angle measure digitally adjustable; for cutting lengths up to 1375 mm, with length compensation for preferred angles 5°, 10°, 15°, 22.5°, 30°, 45°, 60°, 67.5°, incl. splinter block, wall bracket and an additional factor scale for easy calculation of wrong mitres for different workpiece widths.	4380
DIGITAL ANGLE FINE ADJUSTMENT	For the cross-cut fence on the cross slide. With mechanical length compensation instead of the standard angle mitre scale. The digital indicator shows the mitre angle with an accuracy of 0.1 mm.	5509
RIP FENCE WITH CAPACITY 830 MM	To the right of the saw blade with fine adjustment, easy to adjust and fix manually via easy-to-read mm scale on adjustable ruler support.	4752
DIGIT-PAB FOR CUTTING WIDTH 830 MM	Digital wireless absolute measuring system (battery operated) for the rip fence, manual adjustment; with swivelling indicator on the fence, fine adjustment to 0.1 mm; no additional calibration is required, even if the fence has been swivelled under the table. Only in combination with Art. No. 4752 available!	4754
RIP FENCE WITH CAPACITY 1280 MM	To the right of the saw blade with fine adjustment, easy to adjust and fix manually via easy-to-read mm dimension scale on adjustable ruler support.	4753
DIGIT-PAB FOR CUTTING WIDTH 1280 MM	Digital wireless absolute measuring system (battery operated) for the rip fence, manual adjustment; with swivelling indicator on the fence, fine adjustment to 0.1 mm; no additional calibration is required, even if the fence has been swivelled under the table. Only in combination with Art. No. 4753 available!	4756
DIGIT-PAB FOR CUTTING WIDTH 1030 MM	Digital wireless absolute measuring system (battery operated) for the rip fence, manual adjustment; with swivelling indicator on the fence, fine adjustment to 0.1 mm; no additional calibration is required, even if the fence has been swivelled under the table. Only in combination with standard rip fence (1030 mm)!	4755

19.4 Slide Table and additional Supports

Article	Description	Art. No.
REMOTE LOCKING OF THE SLIDE TABLE	For blocking the top slide table at a grid spacing of 70 mm.	4483.1
CUTTING LENGTH OF SLIDE TABLE 2000 MM	Instead of the 3200 mm standard cutting length.	4584
CUTTING LENGTH OF SLIDE TABLE 2600 MM	Instead of the 3200 mm standard cutting length.	4586
CUTTING LENGTH OF SLIDE TABLE 3800 MM	Instead of the 3200 mm standard cutting length.	4405

19.5 Support Systems

Article	Description	Art. No.
ADDITIONAL SUPPORT FOR LARGE PLATES	Can be hooked on the slide table, length 500 mm.	4321
SWIVEL TABLE SUPPORT WITH PLASTIC ROLLER	Adjustable as table extension in the infeed or outfeed area, attached to the aluminium double slide table.	4768
SWIVEL-AWAY DEVICE FOR THE CROSS SLIDE	Quick ergonomic sliding into the parking position.	4770
ADDITIONAL CORNER TABLE	750 X 400 mm for optional cutting width of 800 mm; as additional table support next to the standard table extension.	4772
ADDITIONAL CORNER TABLE	750 X 600 mm for optional cutting width of 1030 mm; as additional table support next to the standard table extension.	4773
ADDITIONAL CORNER TABLE	750 X 890 mm for optional cutting width of 1280 mm; as additional table support next to the standard table extension.	4774
EXTENDABLE SUPPORT ROLLER ON CROSS SLIDE	Extension length 610 mm.	4499

19.6 Special Accessories

Article	Description	Art. No.
LASER INDICATOR	Laser indicator for the cutting kerf, mounted on the guard.	4322
MACHINE SOCKET	For connecting external additional components (e.g. power feeder).	4211
TOOL DRAWER	Integrated in the table extension.	4771
SPRAYING SYSTEM	Minimum quantity lubrication for aluminium and plastics machining.	4324
CENTRAL LUBRICATION	For grease supply to all lubrication points of the machine via hand pump. With 400 g grease cartridge and max. 350 bar output pressure.	4860
SPECIAL VOLTAGE	220 V / 50 Hz max. 7.5 kW	4601
CIRCULAR SAW POWER FEEDER 76	For attachment to the rip fence.	2078



Use only tools, accessories and spare parts specified by the manufacturer. The use of other tools, accessories or spare parts may cause injury to persons and damage to the machine. The manufacturer accepts no liability for any damage resulting from the use of tools, accessories or spare parts not specified by the manufacturer or from additional components supplied by third parties!

20 Disassembly and Scrapping

When dismantling and scrapping the machine, the current EU regulations or the respective regulations and laws of the country of operation, which are prescribed for proper dismantling and disposal, must be observed. The aim is to dismantle the machine and its various materials and components properly, to recycle all possible parts and to dispose of non-recyclable components in the most environmentally friendly way.

	<p>Please pay particular attention to</p> <ul style="list-style-type: none"> • <i>the dismantling of the machine in the working area</i> • <i>proper dismantling of the machine and accessories</i> • <i>a safe and proper removal of the machine</i> • <i>proper separation of all components and materials.</i>
---	--

When dismantling and disposing the machine, the laws and regulations in force at the place of use concerning health and environmental protection must be observed.

	<p>Remove all residues of oil, grease and other lubricants and have them disposed of properly by a qualified disposal company.</p>
---	---

When separating, disposing of or recycling the machine materials, comply with the environmental protection laws in force at the place of use regarding the disposal of industrial solid waste toxic and hazardous waste.

	<ul style="list-style-type: none"> • <i>Hoses and plastic parts as well as other components that are not made of metal must be dismantled and recycled or disposed of separately.</i> • <i>Electrical components such as cables, switches, connectors, transformers, etc. must be removed and (if possible) recycled or otherwise disposed of in a qualified manner.</i> • <i>Pneumatic and hydraulic parts such as valves, solenoid valves, pressure regulators, etc. must be removed and (if possible) recycled or otherwise disposed of in a qualified manner.</i> • <i>Dismantle the base frame and all metal parts of the machine and sort them according to material type. Metals can be melted down and recycled.</i>
--	--

In the event of improper disposal of lubricants, the following residual risks to the environment and health exist:

	<p>Pollution of the environment by seepage into groundwater or sewage system.</p>
---	--

	<p>Poisoning of the personnel contracted for the disposal.</p>
---	---

Note: The disposal of lubricants considered toxic and hazardous must be carried out in accordance with the regulations and laws in force at the respective place of use. Only qualified disposal companies that have the appropriate permits for the disposal of used oil and lubricants are to be commissioned with the disposal.

EU - Declaration of Conformity

in accordance with the EU Machinery Directive 2006/42/EC Annex II A

The manufacturer,

HOKUBEMA Maschinenbau GmbH
Graf-Stauffenberg-Kaserne
Binger Str. 28 | Halle 120
DE 72488 Sigmaringen (Germany)

Phone: +49 (0) 7571 / 755 - 0
Fax: +49 (0) 7571 / 755 - 222

hereby declares that the manufactured machine

SLIDING TABLE SAW 690|100

Machine-No.:

Year of manufacture:

in the version provided complies with the following directives:

- Machinery Directive 2006/42/EG
- EMC Directive 2014/30/EU

The notified body (0392)

Fachausschuss HOLZ
- Prüf- und Zertifizierungsstelle im BG- PrüfZert -
Vollmoellerstraße 11
DE 70563 Stuttgart (Germany)

has carried out an EC type-examination for the above machine.

Mr. Andreas Ganter, Graf-Stauffenberg-Kaserne, Binger Str. 28 | Halle 120,
72488 Sigmaringen (Germany), is authorised to compile the technical documentation.

Type Examination Certificate No.: HO 151105

Sigmaringen, 08.09.2023
.....



Reinhold Beck
Managing Director